



FERVI

FERVI
PREZZO DI LISTINO

+5%

DAL 3 LUGLIO 2023

44

fervi.com

IL CATALOGO

**PER I PROFESSIONISTI
DELLA MANUTENZIONE
E RIPARAZIONE**

***MACCHINE UTENSILI
E ACCESSORI***

UTENSILI DA TAGLIO

ABRASIVI

***ATTREZZATURE
DA OFFICINA***

UTENSILERIA

GENERAL TOOLS

STRUMENTI DI MISURA

- p.004  **TORNI**
- p.028  **FRESATRICI**
- p.039  **TRAPANI**
- p.060  **MACCHINE LAVORAZIONI MECCANICHE**
- p.072  **LAVORAZIONE LAMIERA, FERRI E TUBI**
- p.077  **MACCHINE LAVORAZIONE LEGNO**
- p.096  **MORSE A MACCHINA**
- p.100  **TAVOLE E DIVISORI**
- p.106  **MANDRINI**
- p.121  **CONTROPUNTE E TORRETTE**
- p.127  **ACCESSORI BORDO MACCHINA**
- p.130  **UTENSILI PER TORNITURA E FRESATURA**
- p.151  **INSERTI, BRASATI E BARRETTE**
- p.168  **PUNTE E FRESE DA METALLO**
- p.207  **PUNTE E FRESE DA EDILIZIA E LEGNO**
- p.214  **MASCHI E FILIERE**
- p.221  **RIPARAZIONE FILETTI**
- p.238  **LAME A NASTRO E A DISCO**
- p.242  **DISCHI LAMELLARI**
- p.264  **RUOTE ABRASIVE**
- p.269  **DISCHI E NASTRI ABRASIVI**
- p.279  **PULITURA**
- p.283  **FINITURA E LUCIDATURA**
- p.289  **SPAZZOLE A FILO**
- p.294  **MOLE E DISCHI DA TAGLIO**
- p.306  **ARREDAMENTO DA OFFICINA**
- p.331  **MORSE DA BANCO E INCUDINI**
- p.336  **MACCHINE PER TRATTAMENTI E FINITURE**
- p.353  **PRESSE E DIVARICATORI**
- p.358  **OFFICINA AUTO E MOTO**
- p.368  **SOLLEVAMENTO E MOVIMENTAZIONE**
- p.382  **CHIAVI DI MANOVRA**
- p.400  **CHIAVI A BUSSOLA ED ESTRATTORI**
- p.425  **GIRAVITI E RIVETTATRICI**
- p.440  **PINZE, MARTELLI, LIME, LEVE E SCALPELLI**
- p.455  **CUTTER, SBAVATORI E FORBICI**
- p.464  **ASSORTIMENTI E FISSAGGIO**
- p.469  **EDILIZIA ED IMBALLAGGIO**
- p.472  **SERIE DI UTENSILI**
- p.488  **PNEUMATICA**
- p.503  **SALDATORI, SVERNICIATORI E PISTOLE TERMOCOLLANTI**
- p.506  **ATTREZZATURA PER LIQUIDI E FLUIDI**
- p.514  **ILLUMINAZIONE E RISCALDATORI**
- p.524  **SICUREZZA ED ANTINFORTUNISTICA**
- p.536  **CALIBRI, TRUSCHINI E RIGHE**
- p.544  **COMPARATORI**
- p.548  **MICROMETRI**
- p.550  **BLOCCHETTI, ANELLI E TAMPONI**
- p.553  **ACCESSORI PER LA MISURAZIONE**
- p.561  **FLESSOMETRI, LIVELLE E GONIOMETRI**
- p.565  **MISURATORI ANALOGICI E DIGITALI**
- p.574  **BILANCE E DINAMOMETRI**



FERVI RISPONDE
059.767172

1

UFFICIO COMMERCIALE

- Disponibilità e prezzi prodotti
- Gestione ordini
- Informazioni commerciali
- Rivenditori e rappresentanti
- Preventivi
- Info aziendali

2

ASSISTENZA TECNICA

- Informazioni tecniche
- Richiesta di assistenza
- Disponibilità ricambi
- Garanzia
- Preventivi riparazione

5

LINGUA INGLESE

NUMERO VERDE
800 17 25 99

SOLO DALL'ITALIA

www.fervi.com

[✉ info@fervi.com](mailto:info@fervi.com)



CONTATTACI ANCHE SU FACEBOOK

facebook.com/FerviProSmartEquipment

il nostro ufficio commerciale risponderà alle tue domande nel più breve tempo possibile.



SEGUI IL NOSTRO CANALE YOUTUBE

www.youtube.com/c/Fervitools

potrai vedere le nostre macchine utensili in utilizzo e scoprire la novità dei prodotti a marchio Fervi.



SEGUICI SU LINKEDIN

www.linkedin.com/company/ferviprosmartequipment

potrai rimanere aggiornato sulle nostre novità aziendali e su tutti i nostri grandi progetti.





PREZZI

TUTTI I PREZZI IN QUESTO CATALOGO SI INTENDONO **NON** COMPENSIVI DI IVA





 **TORNI**

- p. 004  — Torni pesanti
- p. 010  — Torni paralleli
- p. 025  — Torni da banco
- p. 026  — Basi per torni

 **FRESATRICI**

- p. 028  — Fresatrici veloci
- p. 033  — Trapani fresa ad ingranaggi
- p. 036  — Trapani fresa a cinghie

 **TRAPANI**

- p. 039  — Trapani radiali
- p. 044  — Trapani a colonna ad ingranaggi
- p. 048  — Trapani a colonna a cinghie
- p. 054  — Trapani da banco
- p. 058  — Trapani magnetici

 **MACCHINE LAVORAZIONI MECCANICHE**

- p. 060  — Seghe a nastro
- p. 065  — Mole da banco
- p. 068  — Affilatrici
- p. 071  — Levigatrici a nastro
- p. 068  — Supporti



 **LAVORAZIONE LAMIERA, FERRI E TUBI**

- p. 072  — Lavorazione lamiera
- p. 075  — Lavorazione ferri e tubi





 **MACCHINE LAVORAZIONE LEGNO**

- p. 077  — Torni
- p. 079  — Pialle
- p. 082  — Seghe circolari e squadratrici
- p. 084  — Troncatrici
- p. 085  — Seghe a nastro
- p. 090  — Levigatrici a nastro
- p. 093  — Aspiratori per trucioli











 **MORSE A MACCHINA**

- p. 096  — Morse di precisione
- p. 097  — Morse a macchina
- p. 099  — Parallele per morse



 **TAVOLE E DIVISORI**

- p. 100  — Divisori
- p. 103  — Tavole
- p. 105  — Piani magnetici
- p. 105  — Staffaggio



 **MANDRINI**

- p. 106  — Mandrini per tornio da metalli
- p. 108  — Mandrini per tornio da legno
- p. 109  — Mandrini porta punte ed accessori
- p. 112  — Mandrini porta pinze
- p. 114  — Mandrini combinati porta frese
- p. 115  — Mandrini porta frese Weldon
- p. 116  — Mandrini porta frese coniche
- p. 117  — Maschiatori
- p. 118  — Testine per alesare
- p. 119  — Smonta mandrini e portaconi

 **CONTROPUNTE E TORRETTE**

- p. 121  — Contropunte
- p. 122  — Torrette

 **ACCESSORI BORDO MACCHINA**

- p. 125  — Refrigerazione
- p. 126  — Protezioni
- p. 127  — Illuminazione









UTENSILI PER TORNITURA E FRESATURA

- p. 132  — Utensili per esterno da tornitura
- p. 138  — Utensili per interno da tornitura
- p. 142  — Utensili per filettare e troncare
- p. 146  — Utensili per fresatura
- p. 152  — Accessori utensili



INSERTI, BRASATI E BARRETTE

- p. 153  — Inserti per tornitura
- p. 163  — Inserti per fresatura
- p. 166  — Inserti per filettare
- p. 166  — Inserti per troncare
- p. 167  — Brasati
- p. 168  — Barrette



PUNTE E FRESE DA METALLO

- p. 170  — Punta cilindriche
- p. 180  — Punta coniche e da centro
- p. 182  — Attacco Weldon
- p. 186  — Seghe a tazza
- p. 194  — Alesatori a macchina
- p. 195  — Lamatori
- p. 196  — Svasatori, utensili allargafori e a gradino
- p. 198  — Frese frontali
- p. 200  — Frese rotative in metallo duro
- p. 208  — Coltelli stozzatori e creatori



PUNTE E FRESE DA EDILIZIA E LEGNO

- p. 209  — Punta cilindriche
- p. 209  — Attacco Sds Plus
- p. 210  — Seghe a tazza
- p. 211  — Utensili diamantati
- p. 214  — Punta e seghe a tazza da legno
- p. 215  — Frese da legno



MASCHI E FILIERE

- p. 216  — Maschi e filiere in serie
- p. 218  — Maschi a macchina
- p. 222  — Filiere e girafilieri





RIPARAZIONE FILETTI

- p. 223  — Serie riparazione filetti
- p. 228  — Inserti filettati
- p. 228  — Maschi per riparazione filetti
- p. 238  — Utensili per riparazione filetti



LAME A NASTRO E A DISCO

- p. 240  — Lame a nastro
- p. 240  — Lame a disco



DISCHI LAMELLARI

- p. 244  Professional
- p. 250  Performance
- p. 254  Grindflex
- p. 258  Smartflex
- p. 261  Specialty
- p. 265  Fast Lock



RUOTE ABRASIVE

- p. 226  Ruote con gambo
- p. 267  Ruote con foro
- p. 268  Ruote per satinatrici



DISCHI E NASTRI ABRASIVI

- p. 271  Dischi in fibra
- p. 272  Dischi adesivi e velcrati
- p. 276  Rotoli e fogli
- p. 278  Nastri



PULITURA

- p. 281  Surface Conditioning
- p. 283  Nylon abrasivo
- p. 284  Non woven



FINITURA E LUCIDATURA

- p. 285  Feltro e paste abrasive
- p. 287  Sisal, cotone e lana
- p. 290  Spugne e gomme abrasive



MOLE E DISCHI DA TAGLIO

- p. 296  Dischi da taglio
- p. 300  Dischi da sbavo
- p. 302  Mole abrasive con foro
- p. 303  Mole abrasive con gambo
- p. 305  Dischi diamantati







SPAZZOLE A FILO

- p. 291  Spazzole con foro
- p. 293  Spazzole con gambo





ARREDAMENTO DA OFFICINA

- p. 310  — Arredamenti modulari
- p. 319  — Banchi da lavoro
- p. 320  — Armadietti e contenitori
- p. 325  — Carrelli portautensili
- p. 328  — Cassette e valigette



MORSE DA BANCO E INCUDINI

- p. 333  — Morse da banco
- p. 335  — Morsetti
- p. 337  — Incudini





MACCHINE PER TRATTAMENTI E FINITURE

- p. 338  — Sabbiatrici
- p. 347  — Lavapezzi
- p. 349  — Aspirapolvere aspiraliquidi
- p. 352  — Marcatura









PRESSE E DIVARICATORI

- p. 355  — Presse idrauliche
- p. 358  — Presse manuali
- p. 359  — Pompe idrauliche

























OFFICINA AUTO E MOTO







- p. 360  — Cric a carrello e cavalletti
- p. 362  — Gruette e supporti motore
- p. 364  — Unità raccogli olio
- p. 365  — Argani per auto
- p. 366  — Caricabatterie
- p. 367  — Sollevatori da moto e quad
- p. 369  — Carrellini sottauto













SOLLEVAMENTO E MOVIMENTAZIONE

- p. 370  — Cric idraulici
- p. 371  — Carrelli
- p. 373  — Paranchi
- p. 374  — Accessori per il sollevamento
- p. 377  — Argani e tendi cavi
- p. 378  — Movimentazione pallet





	CHIAVI DI MANOVRA
p. 384	 — Chiavi a cricchetto
p. 385	 — Chiavi fisse
p. 385	 — Chiavi combinate
p. 388	 — Chiavi poligonali
p. 390	 — Chiavi a tubo
p. 393	 — Chiavi esagonali
p. 395	 — Chiavi torx
p. 397	 — Chiavi a T
p. 398	 — Chiavi per filtro
p. 399	 — Chiavi dinamometriche
	CHIAVI A BUSSOLA ED ESTRATTORI
p. 402	 — Leve a cricchetto
p. 404	 — Chiavi a bussola
p. 418	 — Chiavi a bussola ad impatto
p. 425	 — Estrattori





	GIRAVITI E RIVETTATRICI
p. 427	 — Giraviti a bussola
p. 429	 — Giraviti
p. 433	 — Giraviti di precisione
p. 434	 — Inserti e portainserti
p. 440	 — Rivettatrici a leva

	PINZE, MARTELLI, LIME, LEVE E SCALPELLI
p. 442	 — Pinze
p. 446	 — Pinze grip e a morsetto
p. 446	 — Pinze idrauliche e giratubo
p. 448	 — Martelli e mazzuoli
p. 451	 — Cacciaspine e scalpelli
p. 453	 — Lime
p. 456	 — Leve

	CUTTER, SBAVATORI E FORBICI
p. 457	 — Cutter
p. 459	 — Sbavatori
p. 461	 — Seghetti
p. 462	 — Forbici e cesoie
p. 463	 — Tagliatubi

	ASSORTIMENTI E FISSAGGIO
p. 466	 — Punti per fissatrici e chiodatrici
p. 466	 — Assortimenti

	EDILIZIA ED IMBALLAGGIO
p. 471	 — Pistole per prodotti chimici
p. 472	 — Cazzuole, spatole e frattoni
p. 473	 — Materiale per imballaggio

	SERIE DI UTENSILI
p. 474	 — Carrelli con utensili
p. 478	 — Serie di utensili in termoformati
p. 484	 — Valigette con utensili

	PNEUMATICA
p. 490	 — Fissatrici
p. 492	 — Avvitatori
p. 495	 — Smerigliatrici
p. 495	 — Levigatrici
p. 498	 — Pistole per soffiaggio e gonfiaggio
p. 500	 — Aerografi
p. 503	 — Avvolgitubo

	SALDATORI, SVERNICIATORI E PISTOLE TERMOCOLLANTI
p. 505	 — Saldatori
p. 506	 — Sverniciatori
p. 507	 — Pistole termocollanti





	ATTREZZATURA PER LIQUIDI E FLUIDI
p. 508	 — Oliatori
p. 509	 — Ingrassatori
p. 510	 — Spray
p. 513	 — Taniche
p. 513	 — Nebulizzatori
p. 514	 — Pompe di travaso
	ILLUMINAZIONE E RISCALDATORI

p. 516	 — Riscaldatori
p. 517	 — Faretti LED
p. 518	 — Lampade
p. 520	 — Lenti
p. 520	 — Torce e lampade a batteria
p. 525	 — Avvolgicavo e multiprese

	SICUREZZA ED ANTINFORTUNISTICA
p. 526	 — Detergenti ed igienizzanti
p. 527	 — Guanti
p. 530	 — Occhiali
p. 531	 — Cantiere e primo soccorso
p. 533	 — Cuffie antirumore
p. 534	 — Mascherine
p. 535	 — Scarpe e stivali



CALIBRI, TRUSCHINI E RIGHE

- p. 538  – Calibri digitali
- p. 538  – Calibri con comparatore
- p. 539  – Calibri vernier
- p. 540  – Truschini
- p. 544  – Righe in acciaio e digitali





COMPARATORI

- p. 546  – Comparatori digitali e analogici
- p. 548  – Misuratori di spessore
- p. 549  – Centratori



MICROMETRI

- p. 550  – Micrometri per esterni
- p. 551  – Micrometri per interni



BLOCCHETTI, ANELLI E TAMPONI

- p. 552  – Blocchetti di riscontro
- p. 553  – Anelli e tamponi





ACCESSORI PER LA MISURAZIONE

- p. 555  – Basi magnetiche e supporti
- p. 558  – Piani di riscontro
- p. 558  – Squadre
- p. 560  – Spessimetri e contafiletti







FLESSOMETRI, LIVELLE E GONIOMETRI

- p. 563  – Flessometri
- p. 564  – Livelle
- p. 566  – Goniometri





MISURATORI ANALOGICI E DIGITALI

- p. 567  – Endoscopi e Microscopi
- p. 568  – Pinze amperometriche e multimetri
- p. 569  – Misuratori digitali
- p. 573  – Rifrattometri
- p. 574  – Durometri



BILANCE E DINAMOMETRI

- p. 576  – Bilance
- p. 577  – Dinamometri

FERVI **THE SMART COMPANY**

Sempre al passo coi tempi in tema d'innovazione per anticipare bisogni e desideri dei nostri clienti. Questa è Fervi: leader del settore MRO (Maintenance, Repair and Operations) e partner ideale per ogni esigenza professionale e hobbistica, per la costruzione, manutenzione e riparazione di qualunque oggetto.

Smart come filosofia d'impresa, nei rapporti con clienti e fornitori, ma soprattutto nell'offerta di articoli performanti attraverso piattaforme sempre più tecnologiche, dinamiche e sicure.

Siamo un'azienda solida, affidabile e competitiva, punto di riferimento nello scenario europeo per la ricerca, progettazione, produzione e distribuzione di macchine utensili e utensileria conformi ai più alti requisiti di qualità e affidabilità, protagonisti di un mercato che cresce con noi.

VALUES



**IL CLIENTE AL
CENTRO DI TUTTO**



**MIGLIORAMENTO
CONTINUO**



VISION

Offrire i prodotti più adeguati, più funzionali e sicuri, ai lavoratori dell'industria e dell'artigianato per migliorare concretamente la produttività e la qualità del loro lavoro quotidiano.

MISSION

Progettare e produrre, ricercare e selezionare, distribuire macchine utensili e utensileria con il miglior rapporto qualità-prezzo, garantendo standard qualitativi di sicurezza e di servizio altamente superiori alla media dei nostri concorrenti diretti. La nostra passione per il rinnovamento continuo di prodotti e servizi, il grande rispetto per il lavoro dei nostri clienti e la conoscenza profonda dei bisogni del nostro settore ci identificano come il partner ideale per tutti i grandi progetti o piccoli interventi di manutenzione o riparazione quotidiana.

VALUES



***TRASPARENZA
NEI COMPORAMENTI***



***SPIRITO
DI SQUADRA***

FIT FOR YOU

TIMELINE



2021

Rivit, azienda italiana specializzata nella fornitura di sistemi di fissaggio, entra far parte della famiglia Fervi.



SITGES

2018

Fervi festeggia i suoi primi 40 anni di attività con l'entrata in borsa e acquisisce il 40% di Sitges Maquinas y Acesorios.

2013

Impatto zero raggiunto, i nuovi uffici Fervi sono autosufficienti sotto il profilo energetico.



2011

Cambia la proprietà aziendale, l'azienda si consolida nel suo percorso di crescita.

1978

Veprug Srl nasce e si afferma come grossista del territorio modenese.

2022

Nasce FERVI GROUP: l'identità di ogni azienda è il mattone che costruisce il ponte verso il futuro del settore MRO.

2019



Il 100% di Vogel Germany & Co Kg passa al Gruppo Fervi.

2015



Ampliamento del made in Italy, Ri-flex Abrasives entra nella famiglia Fervi.

2012

Il primo catalogo Fervi è distribuito in 35.000 copie.

1991

Veprug si evolve nel progetto imprenditoriale a marchio Fervi.



2012

3800
referenze



2014

4700
referenze



2016

5700
referenze



2018

6800
referenze

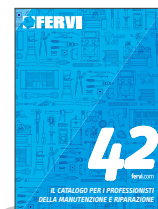

2020

8500+
referenze



2022

8600+
referenze

FERVI GROUP

Machinery and Tools for MRO

GUARDARE AVANTI È NEL DNA DELL'INNOVATORE

La direzione intrapresa e fortemente voluta dal Management è quella della crescita del know-how tecnico e della digital-transformation dei servizi per offrire ai propri clienti un supporto sempre all'avanguardia e in grado di sostenerli nel loro business quotidiano.

Tutto questo è stato possibile unendo saldamente le professionalità e le competenze di tutte le realtà che oggi costituiscono **FERVI GROUP**.

Una sinergia di player di riferimento del settore MRO, pronta a crescere ancora, che oggi getta le basi per un futuro ancora più attento alle evoluzioni del mercato e alla tutela delle risorse e delle persone.



Fondata nel 1978, propone un'offerta che include macchine utensili, utensileria manuale e abrasivi. Oltre 8600 referenze al servizio dei professionisti della manutenzione e riparazione in ambito industriale, artigianale, automotive e del fai-da-te evoluto.



Dal 1982, produttore Made in Italy di dischi abrasivi lamellari di alta qualità tramite macchine automatiche studiate e realizzate internamente. Gli impianti automatici per la produzione dei dischi lamellari sono venduti in tutto il mondo.



Fondata nel 1949, produce e commercializza strumenti di misura di alta gamma, proposti attraverso agenti locali ed una rete di distributori world wide.



Era il 1952 quando nasceva lo storico distributore spagnolo di Fervi, con sede a Barcellona. La distribuzione avviene in forma diretta ed attraverso la propria rete vendita.



Dal 1973, Rivit è il partner ideale per quanto riguarda la produzione e distribuzione di sistemi di fissaggio, utensili per bulloneria e macchine per la lavorazione e l'assemblaggio della lamiera.

Una scelta sempre più completa e affidabile per te.

La strategia di sviluppo adottata dall'azienda ha permesso così di raggiungere una connotazione tale da poter fregiarsi del titolo di primo gruppo italiano del settore MRO, permettendo di essere al fianco dei clienti in ogni situazione.

UNA PRESENZA CAPILLARE. UNA FIDUCIA INTERNAZIONALE.

La nostra distribuzione e assistenza.

Con oltre **4500 punti vendita in Italia**, una presenza in oltre **50 paesi del Mondo** e con più di **8000 clienti**, Fervi Group ha preso oggi una posizione ben definita: quella di essere sempre più vicino ai propri clienti per garantire loro il sostegno quotidiano allo sviluppo del business.

La via intrapresa dal Gruppo è orientata a una costante espansione commerciale, supportata sempre da un'eccellente assistenza tecnica per garantire l'offerta completa dei prodotti e dei servizi in modo capillare, ovunque.

I nostri tecnici altamente specializzati offrono un supporto ed un efficiente servizio di assistenza interno di riparazione oltre che di consulenza in merito all'installazione ed alla manutenzione delle attrezzature.

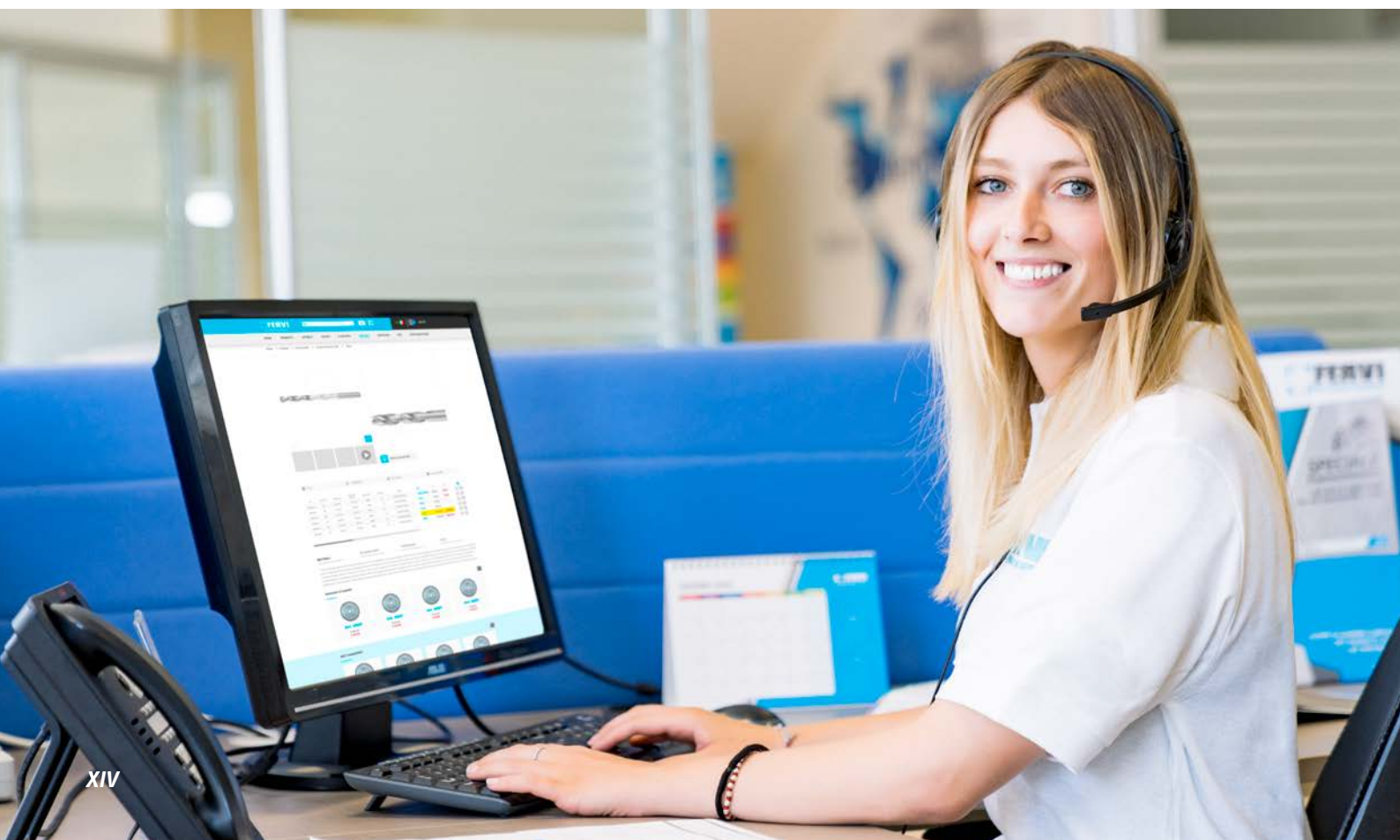

FERVI GROUP

Machinery and Tools for MRO

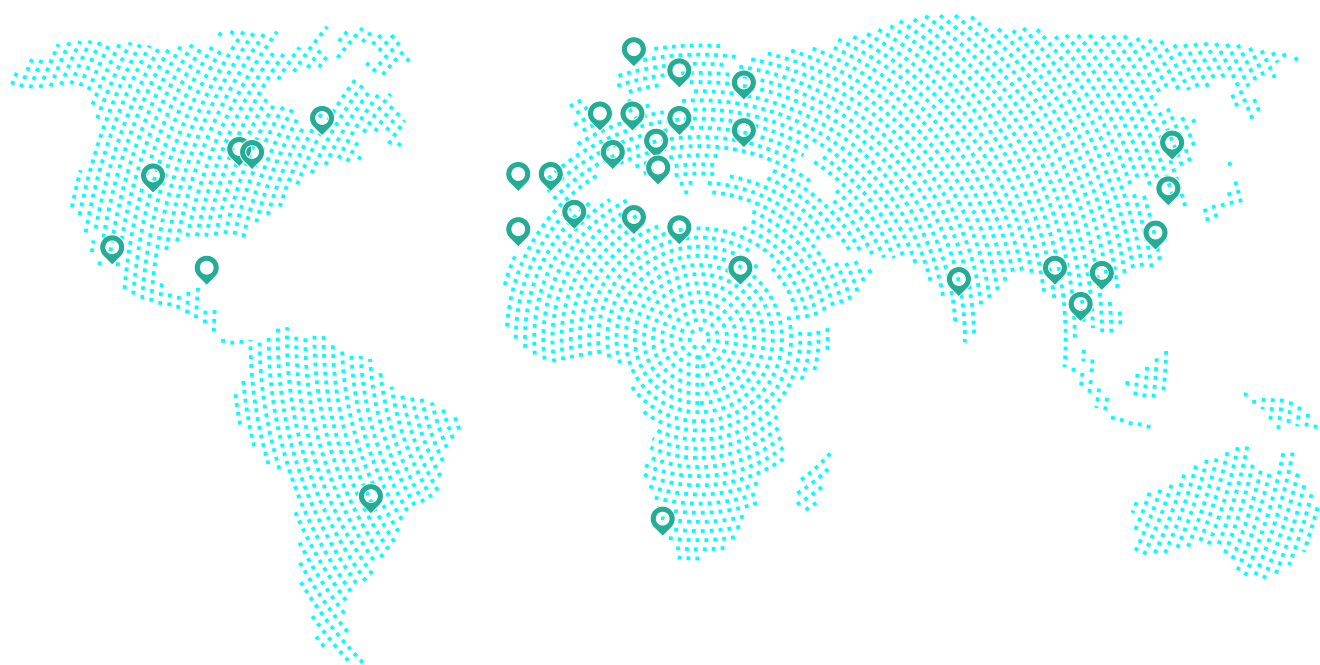

***Un unico indirizzo,
soluzioni personalizzate.***

GESTIONE, ORGANIZZAZIONE, METODO. LA QUALITÀ SECONDO FERVI.

Il metodo Fervi



I nostri numeri

Spazi, persone e orizzonti del mondo Fervi.

1+1

SHOWROOM
FISICO E VIRTUALE

8600+

REFERENZE
A CATALOGO

3000+

REFERENZE
DI RICAMBISTICA

10000m²

DI MAGAZZINO

200M

PEZZI SUL MERCATO

3000+

ORDINI OGNI MESE

Le nostre certificazioni

UNA QUALITÀ CHE NASCE DALLA RESPONSABILITÀ.

Il senso di responsabilità sociale e commerciale di Fervi è alla base di ogni iniziativa e attività intrapresa dai componenti del Gruppo Fervi e da coloro che ne sono coinvolti.

I NOSTRI COLLABORATORI

La nostra forza primaria, tutelata da processi e dispositivi, certificati secondo i più alti standard. Un ambiente sano e sicuro in cui lavorare per un benessere aziendale forte e consolidato.

I NOSTRI CLIENTI

Ogni prodotto a marchio Fervi è la sintesi di tutto ciò per cui ci impegniamo ogni giorno. Alta qualità, affidabilità e sicurezza sempre garantiti al 100%.

I NOSTRI PARTNER

Chi collabora con le realtà del Gruppo Fervi può sempre contare su una affidabilità finanziaria certificata. Un gesto di fiducia in più per costruire rapporti solidi e produttivi.

L'AMBIENTE DI TUTTI

Abbiamo raggiunto l'autosufficienza energetica, grazie all'installazione di impianti fotovoltaici di ultima generazione.

+ ECOSOSTENIBILITÀ

La nostra attenzione alla sostenibilità ambientale ci ha portato a realizzare un catalogo ecosostenibile, utilizzando carta PEFC più leggera e meno trattata con un obiettivo unico: pensare al nostro pianeta risparmiando, nel nostro piccolo, tanta più CO2 possiamo.



FERVI *plus*

Cos'è?

Fervi Plus è un servizio che mette ancora più al centro i clienti Fervi. Come funziona? I prodotti Fervi Plus hanno al loro interno una cartolina con un codice che permette di registrarsi ad un'area riservata del sito Fervi.

Perché Fervi Plus?

Il bollino Fervi Plus garantisce l'ingresso ad un'area cliente completamente dedicata e ad una serie di servizi extra che migliorano l'esperienza di acquisto dei nostri prodotti.



Quali sono i plus?



1. Estensione di un anno della garanzia.



2. Il controllo pre-consegna che aumenta l'attenzione alla qualità.



3. Un numero dedicato all'assistenza tecnica sui prodotti Fervi.



4. I tuoi documenti a portata di click, potrai trovarli tutti nel portale dedicato.

Ecco come funziona la registrazione al servizio FERVI Plus, pochi passi per ottenere il massimo e stare tranquilli di poter usufruire di un servizio senza eguali.

Inquadra il QR Code e guarda il video tutorial.



1. Vai sul sito fervi.com e clicca su Fervi Plus

2. Accedi o registrati creando un account

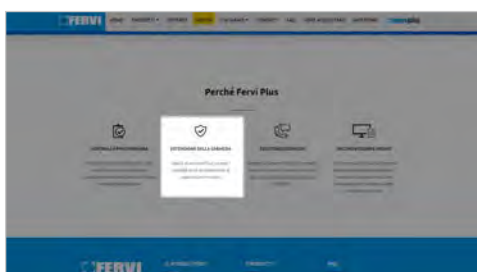

3. Adesso sei il benvenuto all'interno dell'area Fervi Plus

4. Registra un prodotto facendo clic sul pulsante "Registra un nuovo prodotto"

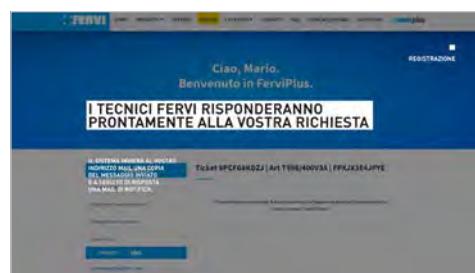
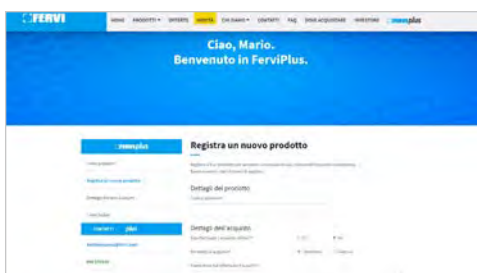

5. Inserisci i dati del prodotto e i dettagli di acquisto

6. Clicca su "Registra il prodotto" e il gioco è fatto. Tutti i Plus sono adesso disponibili per te.

BENVENUTI IN SQUADRA

Costruiremo qualcosa di grande. Insieme.

Supportiamo in ogni appuntamento le realtà sportive nelle quali riconosciamo i nostri stessi valori di senso di appartenenza, il rispetto dell'avversario, la lealtà e l'alta competizione. Aruba.it Racing Ducati - Superbike Team, Vanoli Basket - Lega Basket Serie A, Hockey Cortina - Sportivi Ghiaccio Cortina



FERVI PER LO SPORT



ZIMUDI

sceglie FERVI



FERVI PER L'UNIVERSITÀ

SKYWARD
Experimental Rocketry

 **DYNAMIS**
POLIMI REPARTO CORSE

DIGITAL FERVI

Una qualità tutta da condividere

Fervi è sempre più attenta alle piattaforme digitali e social per mostrare al meglio i suoi prodotti e soddisfare le esigenze della community in tempi rapidi, in ogni momento del giorno.



Sito fervi.com – veloce, dinamico, rinnovato nella grafica e costantemente aggiornato con tutte le informazioni tecniche per approfondire la conoscenza di ogni prodotto.

Dove Acquistare – È molto semplice trovare un rivenditore in cui acquistare i prodotti sul sito Fervi. Basta inserire la propria posizione e il gioco è fatto.





Virtual Show-Room – Il posto ideale per fare un giro virtuale tra gli scaffali e vedere tutti gli strumenti della gamma Fervi.



Inquadra il QR Code con il tuo smartphone o visita fervi.com ed entra nel Virtual Show Room Fervi.

Social – Una pagina Facebook molto attiva grazie alla nostra community ma anche Instagram e Youtube per essere sempre aggiornati e scambiarsi opinioni sul mondo hobbistico e professionale.



FERVI ARREDA

Crea il tuo Showroom

Una proposta esclusiva per i rivenditori autorizzati.

Fervi pensa agli arredi, tu incrementi il fatturato e il rendimento al metro quadro. Oltre 800 clienti hanno deciso di aumentare il proprio business con le soluzioni FERVI Arreda!

Il chilometro azzurro

Siamo orgogliosi di dire che ad oggi, grazie ai nostri clienti sono installati oltre 1000 metri lineari espositivi che permettono una chiara visione dell'offerta e del panorama FERVI in termini di soluzioni

Il campo da calcio azzurro

Al chilometro lineare aggiungiamo 1 campo da calcio fatto di Gazebo FERVI installati presso i nostri rivenditori e punto di riferimento per l'esposizione outdoor.

Oggi FERVI aumenta la sua offerta di soluzioni permettendoti la personalizzazione del punto vendita in base alle tue esigenze.





Pannelli espositivi

Ideale per l'esposizione dell'utensileria manuale



Vele

Ideali per aree espositive con macchine utensili.
La vela identifica l'area FERVI all'interno dell'esposizione



Gazebo

Ideale per esposizioni outdoor di macchine, arredi officina e tutto quanto possa richiedere uno spazio coperto.

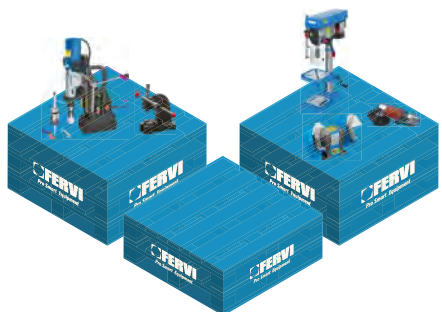

Copri pallet



In tre diverse dimensioni (3,4,5 pallet) per creare delle isole espositive (80x120) per piccole macchine ed utensileria voluminosa utilizzando i pallet presenti in tutte le Rivendite







 **TORNI**

- p. 004  — Torni pesanti
- p. 010  — Torni paralleli
- p. 025  — Torni da banco
- p. 026  — Basi per torni

 **FRESATRICI**

- p. 028  — Fresatrici veloci
- p. 033  — Trapani fresa ad ingranaggi
- p. 036  — Trapani fresa a cinghie

 **TRAPANI**

- p. 039  — Trapani radiali
- p. 044  — Trapani a colonna ad ingranaggi
- p. 048  — Trapani a colonna a cinghie
- p. 054  — Trapani da banco
- p. 058  — Trapani magnetici

 **MACCHINE LAVORAZIONI MECCANICHE**

- p. 060  — Seghe a nastro
- p. 065  — Mole da banco
- p. 068  — Affilatrici
- p. 071  — Levigatrici a nastro
- p. 068  — Supporti



 **LAVORAZIONE LAMIERA, FERRI E TUBI**

- p. 072  — Lavorazione lamiera
- p. 075  — Lavorazione ferri e tubi

 **MACCHINE LAVORAZIONE LEGNO**

- p. 077  — Torni
- p. 079  — Pialle
- p. 082  — Seghe circolari e squadratrici
- p. 084  — Troncatrici
- p. 085  — Seghe a nastro
- p. 090  — Levigatrici a nastro
- p. 093  — Aspiratori per trucioli











 **MORSE A MACCHINA**

- p. 096  — Morse di precisione
- p. 097  — Morse a macchina
- p. 099  — Parallele per morse



 **TAVOLE E DIVISORI**

- p. 100  — Divisori
- p. 103  — Tavole
- p. 105  — Piani magnetici
- p. 105  — Staffaggio



 **MANDRINI**

- p. 106  — Mandrini per tornio da metalli
- p. 108  — Mandrini per tornio da legno
- p. 109  — Mandrini porta punte ed accessori
- p. 112  — Mandrini porta pinze
- p. 114  — Mandrini combinati porta frese
- p. 115  — Mandrini porta frese Weldon
- p. 116  — Mandrini porta frese coniche
- p. 117  — Maschiatori
- p. 118  — Testine per alesare
- p. 119  — Smonta mandrini e portaconi

 **CONTROPUNTE E TORRETTE**

- p. 121  — Contropunte
- p. 122  — Torrette

 **ACCESSORI BORDO MACCHINA**

- p. 125  — Refrigerazione
- p. 126  — Protezioni
- p. 127  — Illuminazione

TORNI PROFESSIONALI

T095F



T080F20



T080F



T075I



T070/400V3A15



T070/400V13A



T070/400V3A



T069/400V..



T998/..



T999/..



T940/230VI..

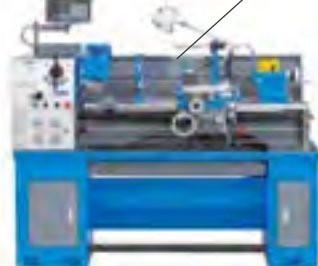

T940/..



TORNI PROFESSIONALI

Diametro mandrino (mm)

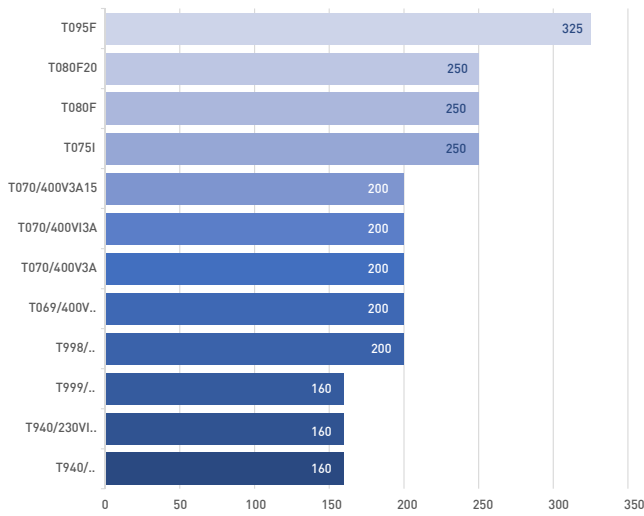

Potenza (W)

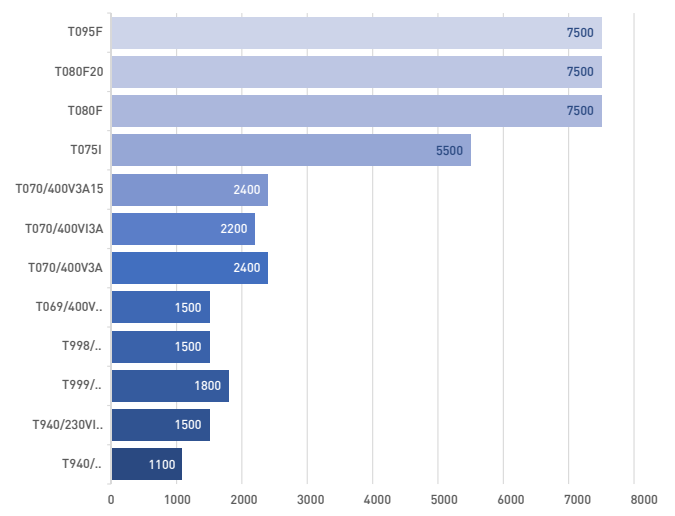

Diametro max sul carro (mm)

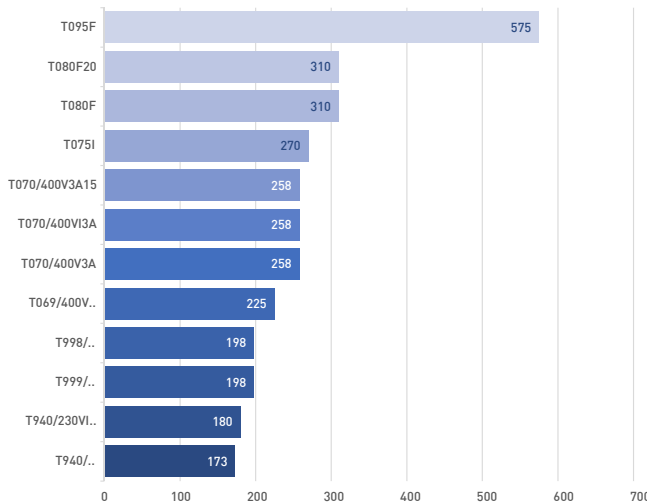

Altezza punta (mm)

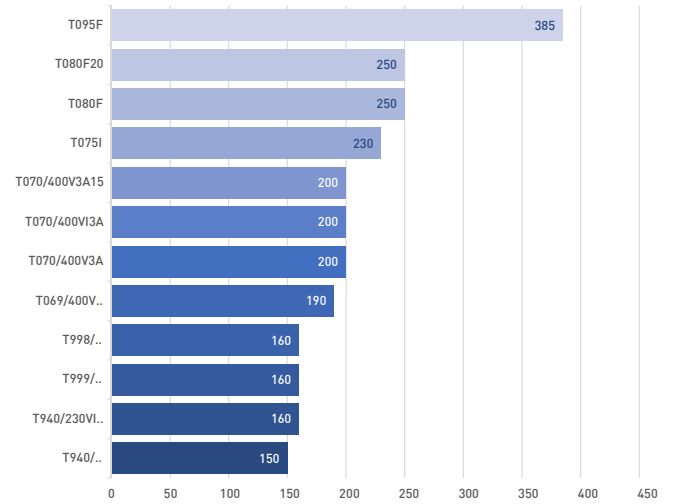

Distanza punta (mm)

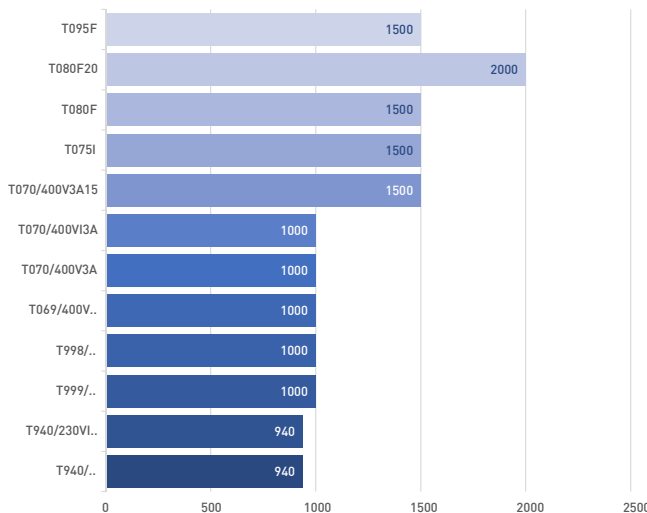

Passaggio barra (mm)

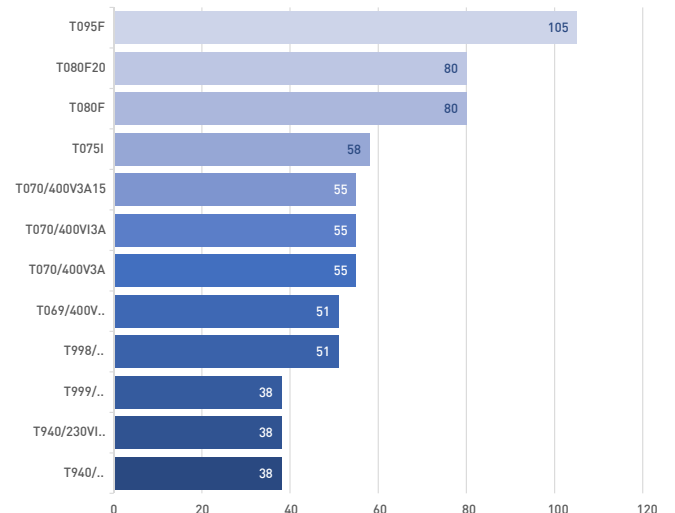

T095F FERVIplus
NEW € 57240,00
TORNIO PARALLELO CON FRIZIONE E VISUALIZZATORE

Con frizione meccanica, visualizzatore a 3 assi e scatola ingranaggi semi norton. Dotato di joystick per l'inserimento degli avanzamenti rapidi. Con basamento in monoblocco di ghisa.

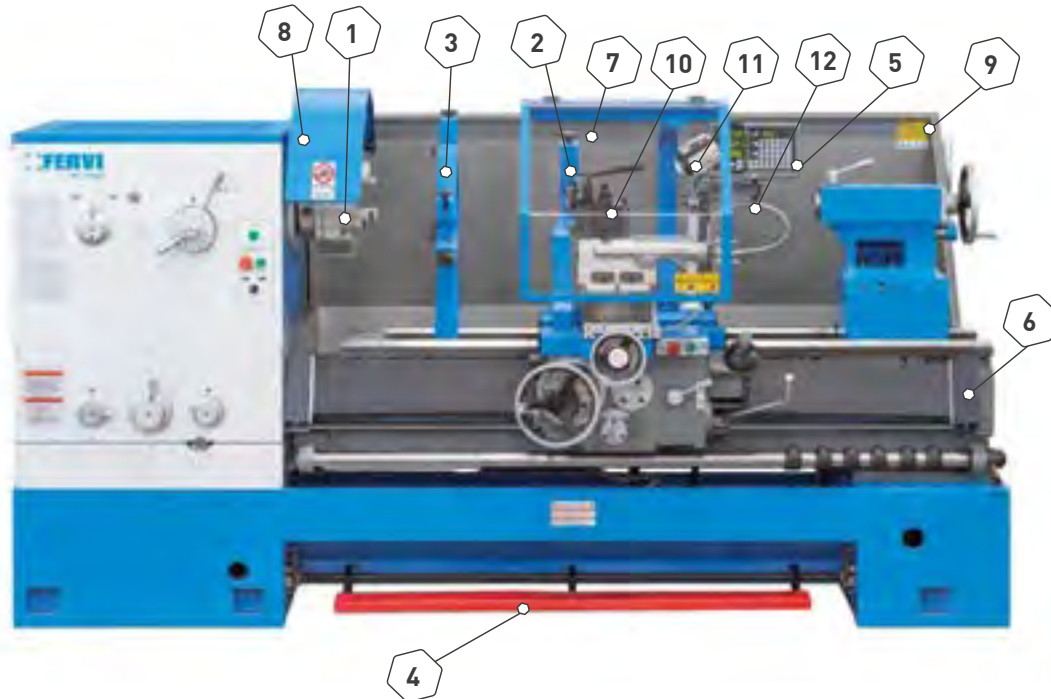

- 1 **Mandrino autocentrante 3+3 Ø 325 mm**
- 2 **Lunetta mobile**
- 3 **Lunetta fissa**
- 4 **Freno a pedale**
- 5 **Visualizzatore a 3 assi**
- 6 **Protezione vite madre**

- 7 **Protezione torretta**
- 8 **Protezione mandrino**
- 9 **Paraspruzzi posteriore**
- 10 **Torretta a cambio rapido**
- 11 **Lampada**
- 12 **Sistema di raffreddamento**

Altezza punta	385 mm
Diametro max sul banco	770 mm
Diametro max sul carro	575 mm
Diametro max sull'incavo	1050 mm
Distanza tra le punte	1500 mm
Passaggio barra	105 mm
Attacco mandrino	Camlock D1-8
Velocità del mandrino	(12) 36 ÷ 1600 rpm
Avanzamenti longitudinali	0,063 ÷ 2,52 mm / giro
Avanzamenti trasversali	0,027 ÷ 1,07 mm/giro
Filettature metriche	1 ÷ 14 mm
Filettature in pollici	2 ÷ 28 TPI
Conicità contropunta CM	5
Motore	400V 50 Hz 7,5 kW
Peso netto	3300 kg

ACCESSORI INCLUSI

- Mandrino autocentrante a 3 griffe reversibili Ø 325 mm
- Piattaforma a 4 griffe indipendenti Ø 400 mm
- Flangia Ø 600 mm
- Lunetta mobile
- Lunetta fissa
- Contropunta rotante CM 5
- Comparatore di filettatura
- Protezione vite madre
- Protezione torretta
- Protezione mandrino
- Paraspruzzi posteriore
- Torretta a cambio rapido tipo C
- Lampada a LED
- Sistema di raffreddamento
- Freno a pedale elettro-meccanico
- Carrello contropunta a bloccaggio rapido
- Ingranaggi del carro a bagno d'olio
- Piedini livellanti regolabili



T080F20 **plus**

NEW € 48060,00

TORNIO PARALLELO CON FRIZIONE E VISUALIZZATORE

Con frizione meccanica, visualizzatore a 3 assi e scatola ingranaggi semi norton. Dotato di joystick per l'inserimento degli avanzamenti rapidi. Con basamento in monoblocco di ghisa.

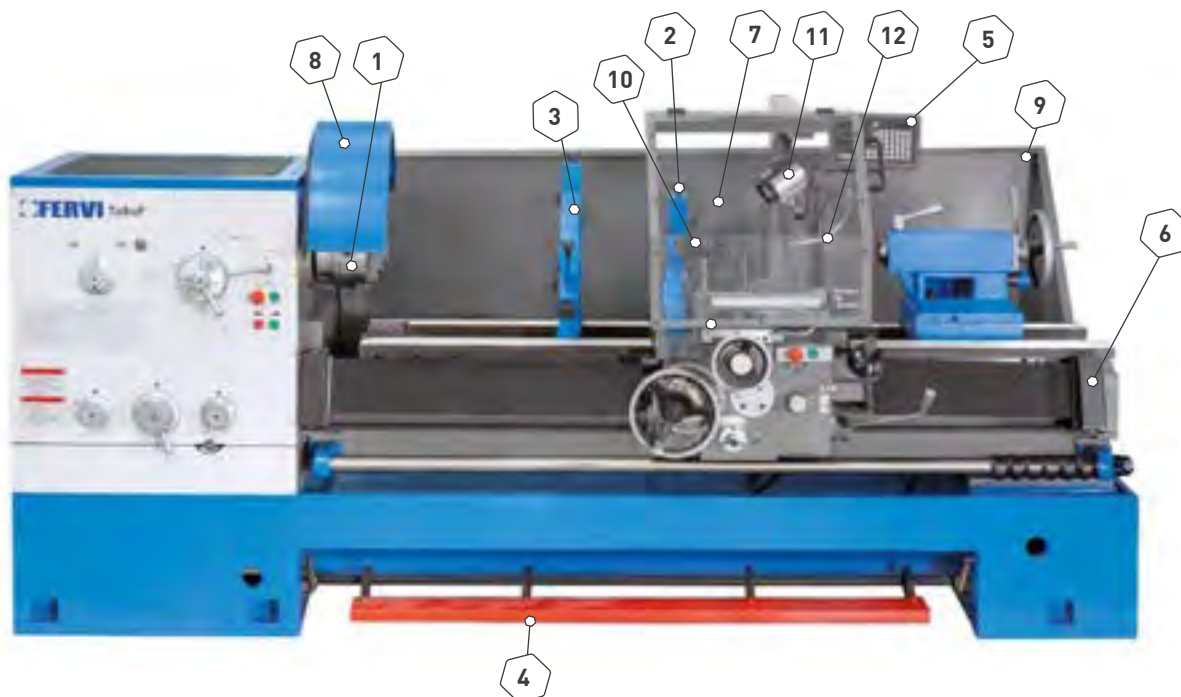

1 Mandrino autocentrante 3+3 Ø 250 mm

2 Lunetta mobile

3 Lunetta fissa

4 Freno a pedale

5 Visualizzatore a 3 assi

6 Protezione vite madre

7 Protezione torretta

8 Protezione mandrino

9 Paraspruzzi posteriore

10 Torretta a cambio rapido

11 Lampada

12 Sistema di raffreddamento

Altezza punte	250 mm
Diametro max sul banco	500 mm
Diametro max sul carro	310 mm
Diametro max sull'incavo	720 mm
Distanza tra le punte	2000 mm
Passaggio barra	80 mm
Attacco mandrino	Camlock D1-8
Conicità passaggio barra CM	7
Velocità del mandrino	(12) 36 ÷ 1600 rpm
Avanzamenti longitudinali	0,063 ÷ 2,52 mm / giro
Avanzamenti trasversali	0,027 ÷ 1,07 mm/giro
Filettature metriche	1 ÷ 14 mm
Filettature in pollici	2 ÷ 28 TPI
Conicità contropunta CM	5
Motore	400V 50 Hz 7,5 kW
Peso netto	3300 kg

ACCESSORI INCLUSI

- Mandrino autocentrante a 3 griffe reversibili Ø 250 mm
- Piattaforma a 4 griffe indipendenti Ø 320 mm
- Bussola di riduzione CM 7/5
- Flangia menabrida Ø 400 mm
- Lunetta mobile
- Lunetta fissa
- 2 x Contropunta fissa CM 5
- Contropunta rotante CM 5
- Comparatore di filettatura
- Protezione vite madre
- Protezione torretta
- Protezione mandrino
- Paraspruzzi posteriore
- Torretta a cambio rapido tipo C
- Lampada a LED
- Sistema di raffreddamento
- Freno a pedale elettro-meccanico
- Carrello contropunta a bloccaggio rapido
- Ingranaggi del carro a bagno d'olio
- Piedini livellanti regolabili



T080F FERVI plus
€ 46100,00
TORNIO PARALLELO CON FRIZIONE E VISUALIZZATORE

Con frizione meccanica, visualizzatore a 3 assi e scatola ingranaggi semi norton. Dotato di joystick per l'inserimento degli avanzamenti rapidi. Con basamento in monoblocco di ghisa.

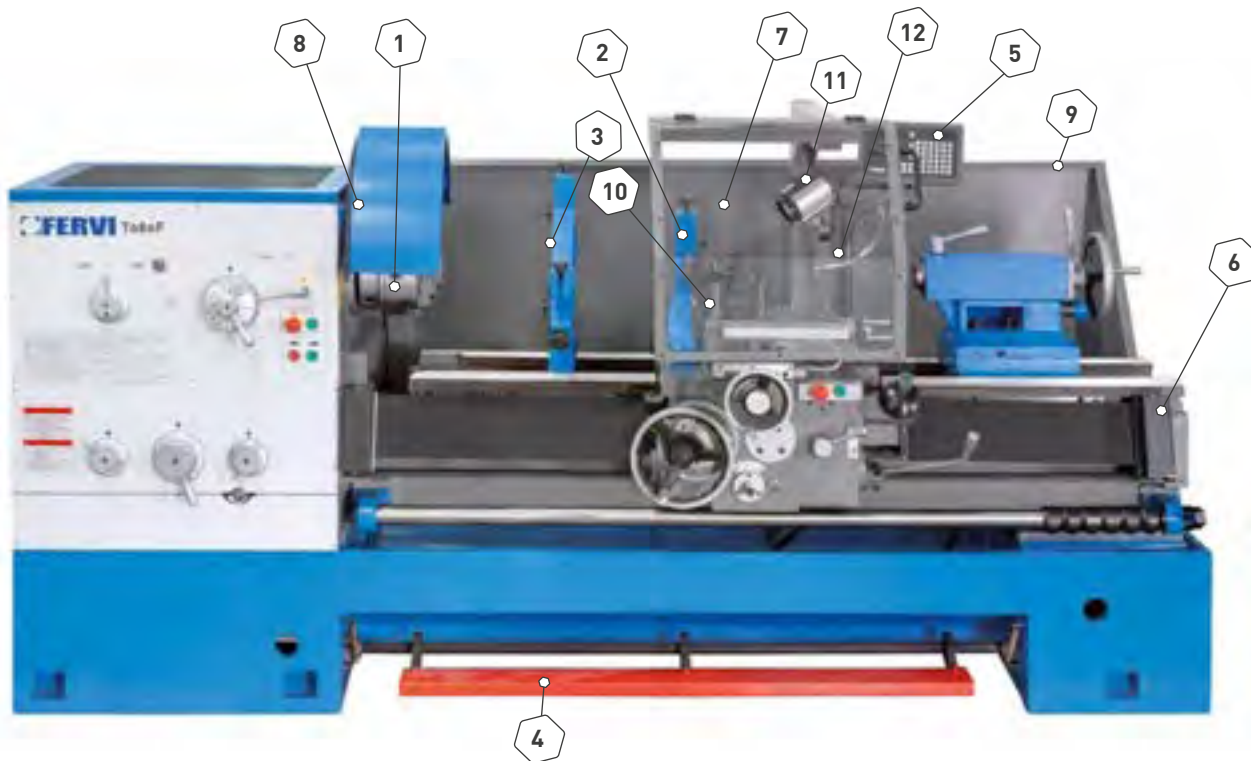

- 1** Mandrino autocentrante 3+3 Ø 250 mm
- 2** Lunetta mobile
- 3** Lunetta fissa
- 4** Freno a pedale
- 5** Visualizzatore a 3 assi
- 6** Protezione vite madre

- 7** Protezione torretta
- 8** Protezione mandrino
- 9** Paraspruzzi posteriore
- 10** Torretta a cambio rapido
- 11** Lampada
- 12** Sistema di raffreddamento

Altezza punta	250 mm
Diametro max sul banco	500 mm
Diametro max sul carro	310 mm
Diametro max sull'incavo	720 mm
Distanza tra le punte	1500 mm
Passaggio barra	80 mm
Attacco mandrino	Camlock D1-8
Conicità passaggio barra CM	7
Velocità del mandrino	(12) 36 ÷ 1600 rpm
Avanzamenti longitudinali	0,063 ÷ 2,52 mm / giro
Avanzamenti trasversali	0,027 ÷ 1,07 mm/giro
Filettature metriche	1 ÷ 14 mm
Filettature in pollici	2 ÷ 28 TPI
Conicità contropunta CM	5
Motore	400V 50 Hz 7,5 kW
Dimensioni	3000 x 1100 x 1700 h mm
Peso netto	3250 kg

ACCESSORI INCLUSI

- Mandrino autocentrante a 3 griffe reversibili Ø 250 mm
- Piattaforma a 4 griffe indipendenti Ø 320 mm
- Bussola di riduzione CM 7/5
- Flangia menabrida Ø 400 mm
- Lunetta mobile
- Lunetta fissa
- 2 x Contropunta fissa CM 5
- Contropunta rotante CM 5
- Comparatore di filettatura
- Protezione vite madre
- Protezione torretta
- Protezione mandrino
- Paraspruzzi posteriore
- Torretta a cambio rapido tipo C
- Lampada a LED
- Sistema di raffreddamento
- Freno a pedale elettro-meccanico
- Carrello contropunta a bloccaggio rapido
- Ingranaggi del carro a bagno d'olio
- Piedini livellanti regolabili

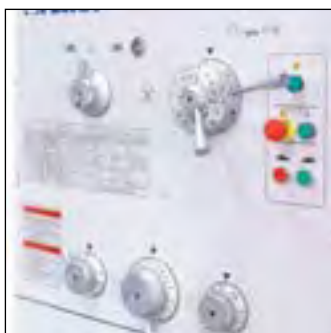

T075I

€ 35880,00

TORNIO PARALLELO CON VISUALIZZATORE ED INVERTER

Visualizzatore a 3 assi con comando di variazione della velocità, scatola ingranaggi semi norton. Con basamento in monoblocco di ghisa. Il Visualizzatore-computer varia la velocità di rotazione in base al diametro tornito.

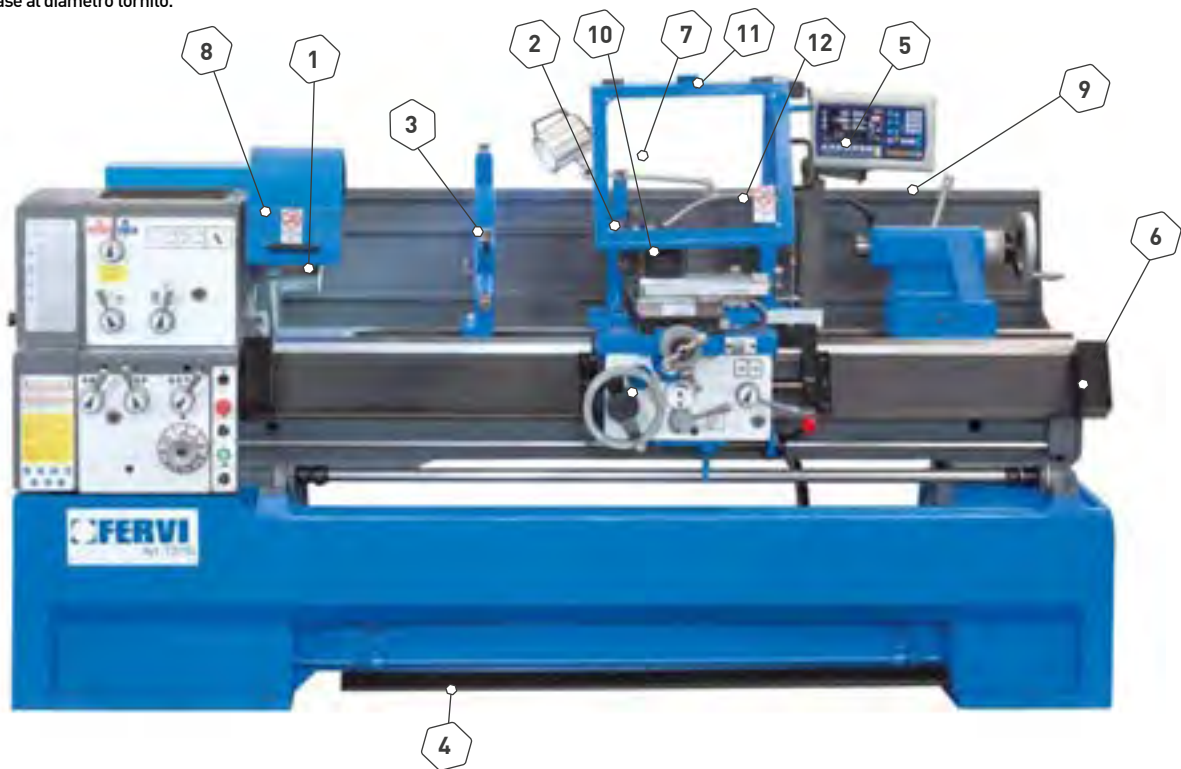

- 1** Mandrino autocentrante 3+3 Ø 250 mm
- 2** Lunetta mobile
- 3** Lunetta fissa
- 4** Freno a pedale
- 5** Visualizzatore a 3 assi
- 6** Protezione vite madre

- 7** Protezione torretta
- 8** Protezione mandrino
- 9** Paraspruzzi posteriore
- 10** Torretta a cambio rapido
- 11** Lampada LED
- 12** Sistema di raffreddamento

Altezza punta	230 mm
Diametro max sul banco	460 mm
Diametro max sul carro	270 mm
Diametro max sull'incavo	690 mm
Distanza tra le punte	1500 mm
Passaggio barra	58 mm
Attacco mandrino	Camlock D1-6
Conicità passaggio barra CM	6
Velocità variabile del mandrino	(2) 30 ÷ 600 600 ÷ 2000 rpm
Avanzamenti longitudinali	0,014 ÷ 0,784 mm / giro
Avanzamenti trasversali	0,031 ÷ 1,7 mm/giro
Filettature metriche	0,1 ÷ 14 mm
Filettature in pollici	2 ÷ 112 TPI
Conicità contropunta CM	4
Motore	400V 50/60 Hz 5,5 kW
Dimensioni	2750 x 1080 x 1650 h mm
Dimensioni	2750 x 1080 x 1650 h mm
Peso netto	1970 kg

ACCESSORI INCLUSI

- Mandrino autocentrante 3+3 Ø 250 mm
- Piattaforma a 4 griffe indipendenti Ø 250 mm
- Bussola di riduzione CM 6/4
- Flangia menabrida Ø 350 mm
- Lunetta mobile
- Lunetta fissa
- 2 x Contropunta fissa CM 4
- Contropunta rotante CM 4
- Comparatore di filettatura
- Protezione vite madre
- Protezione torretta
- Protezione mandrino
- Paraspruzzi posteriore
- Torretta a cambio rapido tipo B
- Lampada a LED
- Sistema di raffreddamento
- Freno a pedale elettromeccanico
- Carrello contropunta a bloccaggio rapido
- Ingranaggi del carro a bagno d'olio



T070/400V3A15
€ 15520,00
TORNIO PARALLELO CON VISUALIZZATORE

Con elettrofreno e motore a 2 velocità, visualizzatore a 3 assi e scatola ingranaggi semi norton. Barra di tornitura con frizione registrabile.

1 Mandrino autocentrante 3+3 Ø 200 mm
2 Lunetta mobile
3 Lunetta fissa
4 Freno a pedale
5 Comparatore di filettatura
6 Protezione vite madre
7 Protezione torretta
8 Protezione mandrino
9 Paraspruzzi posteriore
10 Torretta a cambio rapido T0AB
11 Lampada
12 Sistema di raffreddamento

Altezza punta	200 mm
Diametro max sul banco	400 mm
Diametro max sul carro	258 mm
Distanza tra le punte	1500 mm
Passaggio barra	55 mm
Attacco mandrino	Camlock D1-5
Conicità passaggio barra CM	6
Velocità del mandrino	(12) 45 ÷ 2000 rpm
Avanzamenti longitudinali	0,06 ÷ 2,78 mm / giro
Avanzamenti trasversali	0,01 ÷ 0,72 mm/giro
Filettature metriche	0,8 ÷ 14 mm
Filettature in pollici	2 ÷ 28 TPI
Conicità contropunta CM	4
Motore	400V 50 Hz 1,5 / 2,4 kW
Dimensioni	2360 x 760 x 1600 h mm
Peso netto	1000 kg

ACCESSORI INCLUSI

- Mandrino autocentrante 3+3 Ø 200 mm
- Piattaforma a 4 griffe indipendenti Ø 200 mm
- Bussola di riduzione CM 6/4
- Flangia menabrida Ø 320 mm
- Lunetta mobile
- Lunetta fissa
- 2 x Contropunta fissa CM 4
- Contropunta rotante CM 4
- Comparatore di filettatura
- Protezione vite madre
- Protezione torretta
- Protezione mandrino
- Paraspruzzi posteriore
- Torretta a cambio rapido T0AB
- Lampada a LED
- Sistema di raffreddamento
- Freno a pedale
- Frizione su barra di tornitura
- Carrello contropunta a bloccaggio rapido
- Ingranaggi del carro a bagno d'olio



T070/400VI3A

€ 15930,00

TORNIO PARALLELO CON INVERTER E VISUALIZZATORE

Scatola ingranaggi semi norton e visualizzatore a 3 assi. Barra di tornitura con frizione registrabile e visualizzatore della velocità di rotazione

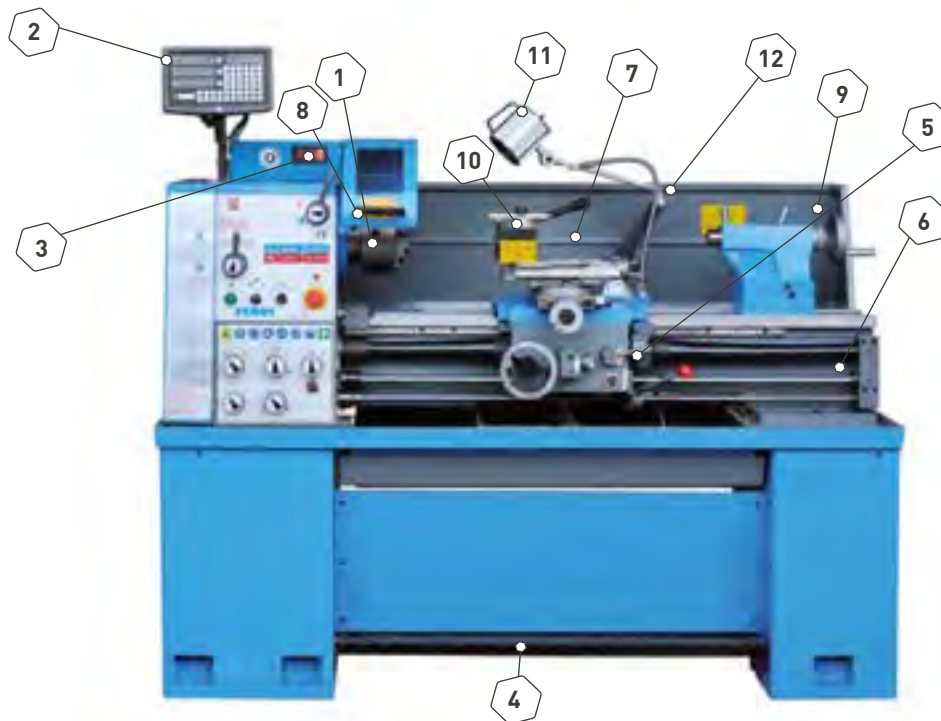

- 1** Mandrino autocentrante 3+3 Ø 200 mm
- 2** Visualizzatore a 3 assi
- 3** Selettore velocità
- 4** Freno a pedale
- 5** Comparatore di filettatura
- 6** Protezione vite madre

- 7** Protezione torretta
- 8** Protezione mandrino
- 9** Paraspruzzi posteriore
- 10** Torretta a cambio rapido TOAB
- 11** Lampada LED
- 12** Sistema di raffreddamento

Altezza punta	200 mm
Diametro max sul banco	400 mm
Diametro max sul carro	258 mm
Diametro max sull'incavo	550 mm
Distanza tra le punte	1000 mm
Passaggio barra	55 mm
Attacco mandrino	Camlock D1-5
Conicità passaggio barra CM	6
Velocità variabile del mandrino	{2} 50 ÷ 1000 50 ÷ 2000 rpm
Avanzamenti longitudinali	0,06 ÷ 2,78 mm / giro
Avanzamenti trasversali	0,01 ÷ 0,72 mm/giro
Filettature metriche	0,8 ÷ 14 mm
Filettature in pollici	2 ÷ 28 TPI
Conicità contropunta CM	4
Motore	400V 50 Hz 2,2 kW
Dimensioni	1860 x 900 x 1650 h mm
Peso netto	780 kg

ACCESSORI INCLUSI

- Mandrino autocentrante 3+3 Ø 200 mm
- Piattaforma a 4 griffe indipendenti Ø 200 mm
- Bussola di riduzione CM 6/4
- Flangia menabrida Ø 320 mm
- Lunetta mobile
- Lunetta fissa
- 2 x Contropunta fissa CM 4
- Contropunta rotante CM 4
- Comparatore di filettatura
- Protezione vite madre
- Protezione torretta
- Protezione mandrino
- Paraspruzzi posteriore
- Torretta a cambio rapido TOAB
- Lampada
- Sistema di raffreddamento
- Frizione su barra di tornitura
- Freno a pedale
- Carrello contropunta a bloccaggio rapido
- Ingranaggi del carro a bagno d'olio



T070/400V3A FERVI plus
€ 14380,00
TORNIO PARALLELO CON VISUALIZZATORE

Con elettrofreno e motore a 2 velocità, visualizzatore a 3. Barra di tornitura con frizione registrabile.

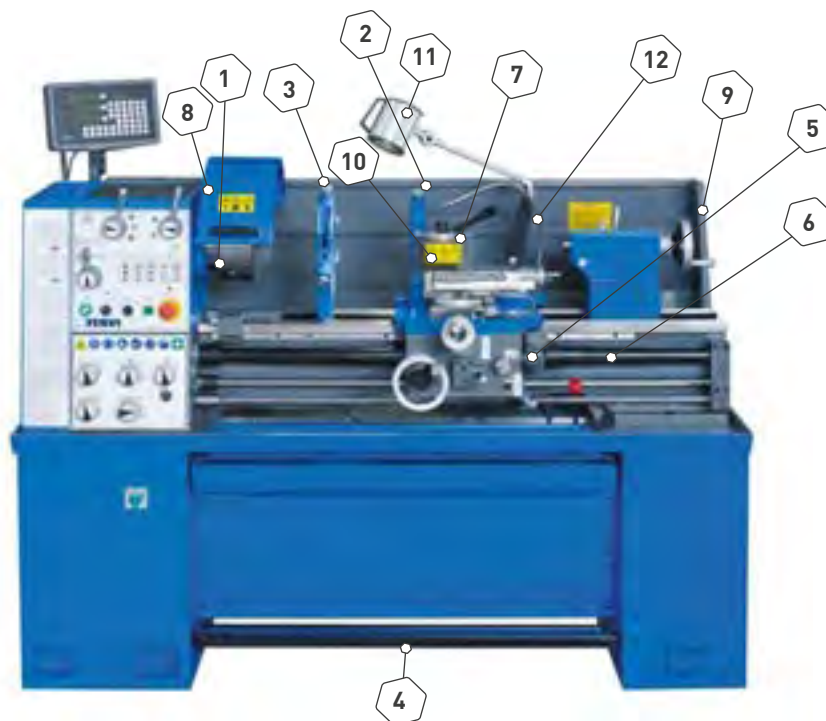

- 1** Mandrino autocentrante 3+3 Ø 200 mm
- 2** Lunetta mobile
- 3** Lunetta fissa
- 4** Freno a pedale
- 5** Comparatore di filettatura
- 6** Protezione vite madre

- 7** Protezione torretta
- 8** Protezione mandrino
- 9** Paraspruzzi posteriore
- 10** Torretta a cambio rapido T0AB
- 11** Lampada LED
- 12** Sistema di raffreddamento

Altezza punta	200 mm
Diametro max sul banco	400 mm
Diametro max sul carro	258 mm
Diametro max sull'incavo	550 mm
Distanza tra le punte	1000 mm
Passaggio barra	55 mm
Attacco mandrino	Camlock D1-5
Conicità passaggio barra CM	6
Velocità del mandrino	(12) 45 ÷ 2000 rpm
Avanzamenti longitudinali	0,06 ÷ 2,78 mm / giro
Avanzamenti trasversali	0,01 ÷ 0,72 mm/giro
Filettature metriche	0,8 ÷ 14 mm
Filettature in pollici	2 ÷ 28 TPI
Conicità contropunta CM	4
Motore	400V 50 Hz 1,5 / 2,4 kW
Dimensioni	1860 x 800 x 1600 h mm
Peso netto	760 kg

ACCESSORI INCLUSI

- Mandrino autocentrante 3+3 Ø 200 mm
- Piattaforma a 4 griffe indipendenti Ø 200 mm
- Bussola di riduzione CM 6/4
- Flangia menabrida Ø 320 mm
- Lunetta mobile
- Lunetta fissa
- 2 x Contropunta fissa CM 4
- Contropunta rotante CM 4
- Comparatore di filettatura
- Protezione vite madre
- Protezione torretta
- Protezione mandrino
- Paraspruzzi posteriore
- Torretta a cambio rapido T0AB
- Lampada a LED
- Sistema di raffreddamento
- Freno a pedale
- Frizione su barra di tornitura
- Carrello contropunta a bloccaggio rapido
- Ingranaggi del carro a bagno d'olio



T069/400VI3A

€ 13000,00

TORNIO PARALLELO CON INVERTER E VISUALIZZATORE

Scatola ingranaggi semi norton e visualizzatore a 3 assi. Barra di tornitura con frizione registrabile e visualizzatore della velocità di rotazione

 1 **Mandrino autocentrante 3+3 Ø 200 mm**

 2 **Freno a pedale**

 3 **Comparatore di filettatura**

 4 **Protezione vite madre**

 5 **Protezione torretta**

 6 **Protezione mandrino**

 7 **Paraspruzzi posteriore**

 8 **Torretta a cambio rapido T0AE**

 9 **Lampada LED**

 10 **Sistema di raffreddamento**

Altezza punte	190 mm
Diametro max sul banco	380 mm
Diametro max sul carro	225 mm
Diametro max sull'incavo	503 mm
Distanza tra le punte	1000 mm
Passaggio barra	51 mm
Attacco mandrino	Camlock D1-5
Conicità passaggio barra CM	6
Velocità variabile del mandrino	{2} 70 ÷ 400 50 ÷ 2000 rpm
Avanzamenti longitudinali	0,052 - 1,392 mm / giro
Avanzamenti trasversali	0,014 - 0,380 mm/giro
Filettature metriche	0,4 - 7 mm
Filettature in pollici	4 - 56 TPI
Conicità contropunta CM	4
Motore	400V 50 Hz 1,5 kW
Dimensioni	1820 x 90 x 1650 h mm
Peso netto	645 kg

ACCESSORI INCLUSI

- Mandrino autocentrante 3+3 Ø 200 mm
- Mandrino a 4 griffe indipendenti reversibili Ø 200 mm
- Bussola di riduzione CM 6/4
- Flangia Ø 320 mm
- Lunetta mobile
- Lunetta fissa
- 2 x Contropunta fissa CM 4
- Contropunta rotante CM 4
- Comparatore di filettatura
- Protezione vite madre
- Protezione torretta
- Protezione mandrino
- Paraspruzzi posteriore
- Torretta a cambio rapido T0AE
- Lampada
- Sistema di raffreddamento
- Freno a pedale
- Frizione su barra di tornitura
- Carrello contropunta a bloccaggio rapido
- Ingranaggi del carro a bagno d'olio



T069/400V3A FERVI plus
€ 11730,00
TORNIO PARALLELO CON VISUALIZZATORE

Visualizzatore a 3 assi e scatola ingranaggi semi norton. Barra di tornitura con frizione registrabile.

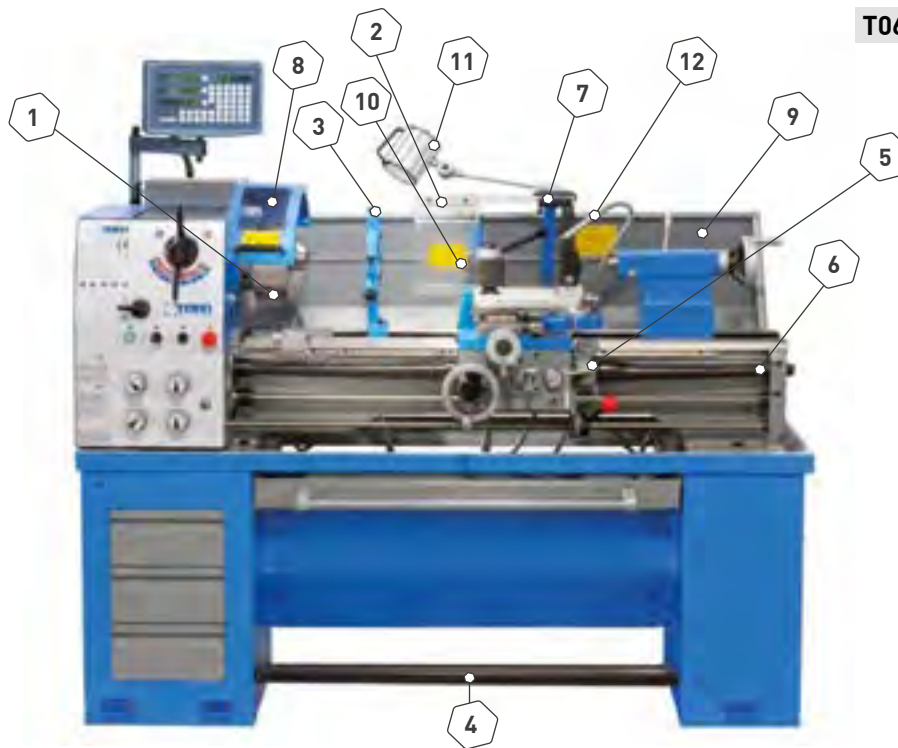
T069/400V € 10690,00
SENZA VISUALIZZATORE

- 1** Mandrino autocentrante 3+3 Ø 200 mm
- 2** Lunetta mobile
- 3** Lunetta fissa
- 4** Freno a pedale
- 5** Comparatore di filettatura
- 6** Protezione vite madre

- 7** Protezione torretta
- 8** Protezione mandrino
- 9** Paraspruzzi posteriore
- 10** Torretta a cambio rapido TOAE
- 11** Lampada LED
- 12** Sistema di raffreddamento

Altezza punta	190 mm
Diametro max sul banco	380 mm
Diametro max sul carro	225 mm
Diametro max sull'incavo	503 mm
Distanza tra le punte	1000 mm
Passaggio barra	51 mm
Attacco mandrino	Camlock D1-5
Conicità passaggio barra CM	6
Velocità del mandrino	70 ÷ 2000 rpm
Avanzamenti longitudinali	0,052 ÷ 1,392 mm / giro
Avanzamenti trasversali	0,014 ÷ 0,380 mm/giro
Filettature metriche	0,4 ÷ 7 mm
Filettature in pollici	4 ÷ 56 TPI
Conicità contropunta CM	4
Motore	400V 50 Hz 1,5 kW
Dimensioni	1800 x 800 x 1600 h mm
Peso netto	640 kg

ACCESSORI INCLUSI

- Mandrino autocentrante 3+3 Ø 200 mm
- Mandrino a 4 griffe indipendenti reversibili Ø 200 mm
- Bussola di riduzione CM 6/4
- Flangia menabrida Ø 320 mm
- Lunetta mobile
- Lunetta fissa
- 2 x Contropunta fissa CM 4
- Contropunta rotante CM 4
- Comparatore di filettatura
- Protezione vite madre
- Protezione torretta
- Protezione mandrino
- Paraspruzzi posteriore
- Torretta a cambio rapido TOAE
- Lampada a LED
- Sistema di raffreddamento
- Freno a pedale
- Frizione su barra di tornitura
- Carrello contropunta a bloccaggio rapido
- Ingranaggi del carro a bagno d'olio



T998/400VI3A

€ 11890,00

TORNIO PARALLELO CON INVERTER E VISUALIZZATORE

Scatola ingranaggi semi norton e visualizzatore a 3 assi. Barra di tornitura con frizione registrabile e visualizzatore della velocità di rotazione

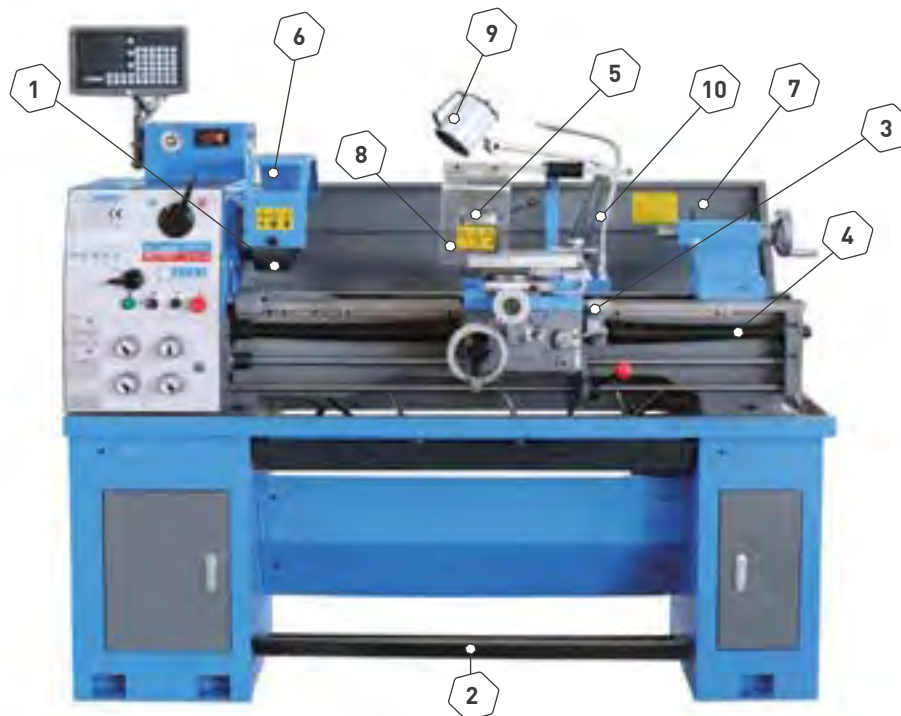
1 Mandrino autocentrante 3+3 Ø 200 mm
2 Freno a pedale
3 Comparatore di filettatura
4 Protezione vite madre
5 Protezione torretta
6 Protezione mandrino
7 Paraspruzzi posteriore
8 Torretta a cambio rapido TOAE
9 Lampada LED
10 Sistema di raffreddamento

Altezza punte	160 mm
Diametro max sul banco	320 mm
Diametro max sul carro	198 mm
Diametro max sull'incavo	470 mm
Distanza tra le punte	1000 mm
Passaggio barra	51 mm
Attacco mandrino	Camlock D1-5
Conicità passaggio barra CM	5
Velocità variabile del mandrino	(2) 70 ÷ 400 350 ÷ 2000 rpm
Avanzamenti longitudinali	0.052 ÷ 1.392 mm / giro
Avanzamenti trasversali	0.009 ÷ 0.253 mm/giro
Filettature metriche	0,4 ÷ 7 mm
Filettature in pollici	4 ÷ 56 TPI
Conicità contropunta CM	3
Motore	400V 50 Hz 1,5 kW
Dimensioni	1820 x 900 x 1650 h mm
Peso netto	635 kg

ACCESSORI INCLUSI

- Mandrino autocentrante 3+3 Ø 200 mm
- Mandrino a 4 griffe indipendenti reversibili Ø 200 mm
- Bussola di riduzione CM 5/3
- Flangia Ø 250 mm
- Lunetta mobile
- Lunetta fissa
- 2 x Contropunta fissa CM 3
- Contropunta rotante CM 3
- Comparatore di filettatura
- Protezione vite madre
- Protezione torretta
- Protezione mandrino
- Paraspruzzi posteriore
- Torretta a cambio rapido TOAE
- Lampada
- Sistema di raffreddamento
- Frizione su barra di tornitura
- Freno a pedale elettromeccanico
- Carrello contropunta a bloccaggio rapido
- Ingranaggi del carro a bagno d'olio



T998/230V3A & T998/400V3A FERVIplus
€ 10600,00
TORNIO PARALLELO CON VISUALIZZATORE

Visualizzatore a 3 assi, scatola ingranaggi semi norton. Barra di tornitura con frizione registrabile.

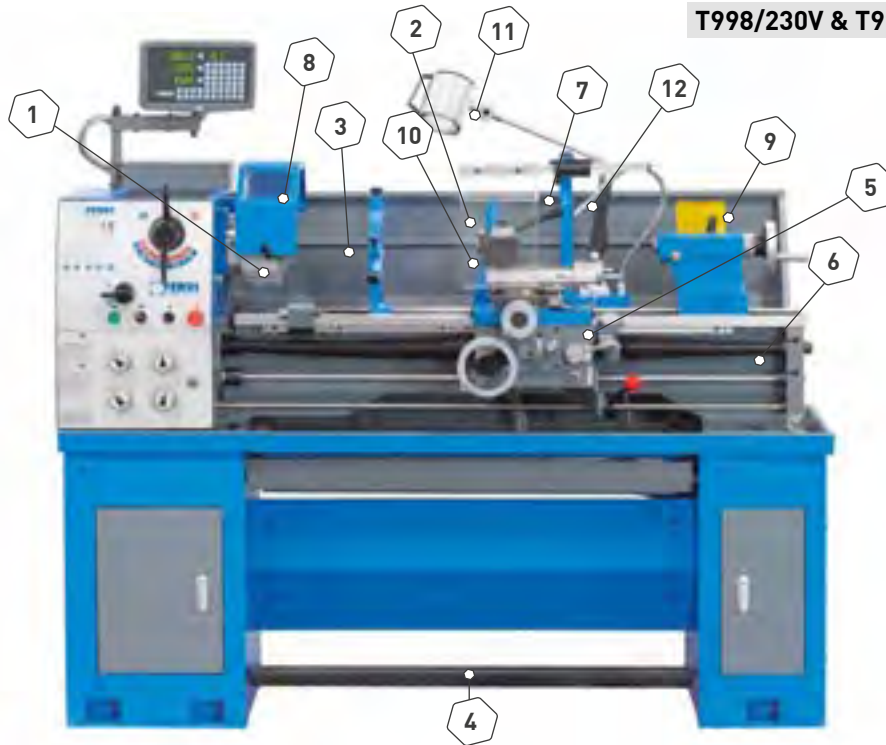
T998/230V & T998/400V
€ 9600,00
SENZA VISUALIZZATORE

- 1** Mandrino autocentrante 3+3 Ø 200 mm
- 2** Lunetta mobile
- 3** Lunetta fissa
- 4** Freno a pedale
- 5** Comparatore di filettatura
- 6** Protezione vite madre

- 7** Protezione torretta
- 8** Protezione mandrino
- 9** Paraspruzzi posteriore
- 10** Torretta a cambio rapido T0AE
- 11** Lampada LED
- 12** Sistema di raffreddamento

Altezza punte	160 mm
Diametro max sul banco	320 mm
Diametro max sul carro	198 mm
Diametro max sull'incavo	470 mm
Distanza tra le punte	1000 mm
Passaggio barra	51 mm
Attacco mandrino	Camlock D1-5
Conicità passaggio barra CM	5
Velocità del mandrino	(8) 70 ÷ 2000 rpm
Avanzamenti longitudinali	0.052 ÷ 1.392 mm / giro
Avanzamenti trasversali	0.009 ÷ 0.253 mm/giro
Filettature metriche	0,4 ÷ 7 mm
Filettature in pollici	4 ÷ 56 TPI
Conicità contropunta CM	3
Motore	230 V 50 Hz 1,8 kW 400 V 50 Hz 1,5 kW
Dimensioni	1820 x 800 x 1320 h mm
Peso netto	630 kg

ACCESSORI INCLUSI

- Mandrino autocentrante 3+3 Ø 200 mm
- Mandrino a 4 griffe indipendenti reversibili Ø 200 mm
- Bussola di riduzione CM 5/3
- Flangia menabrida Ø 250 mm
- Lunetta mobile
- Lunetta fissa
- 2 x Contropunta fissa CM 3
- Contropunta rotante CM 3
- Freno a pedale elettromeccanico
- Comparatore di filettatura
- Protezione vite madre
- Protezione torretta
- Protezione mandrino
- Paraspruzzi posteriore
- Torretta a cambio rapido T0AE
- Lampada
- Sistema di raffreddamento
- Frizione su barra di tornitura
- Carrello contropunta a bloccaggio rapido
- Ingranaggi del carro a bagno d'olio



T999/230V3A & T999/400V3A

€ 10120,00

TORNIO PARALLELO CON VISUALIZZATORE

Visualizzatore a 3 assi, scatola ad ingranaggi semi norton. Barra di tornitura con frizione registrabile.

T999/230V & T999/400V

€ 8880,00

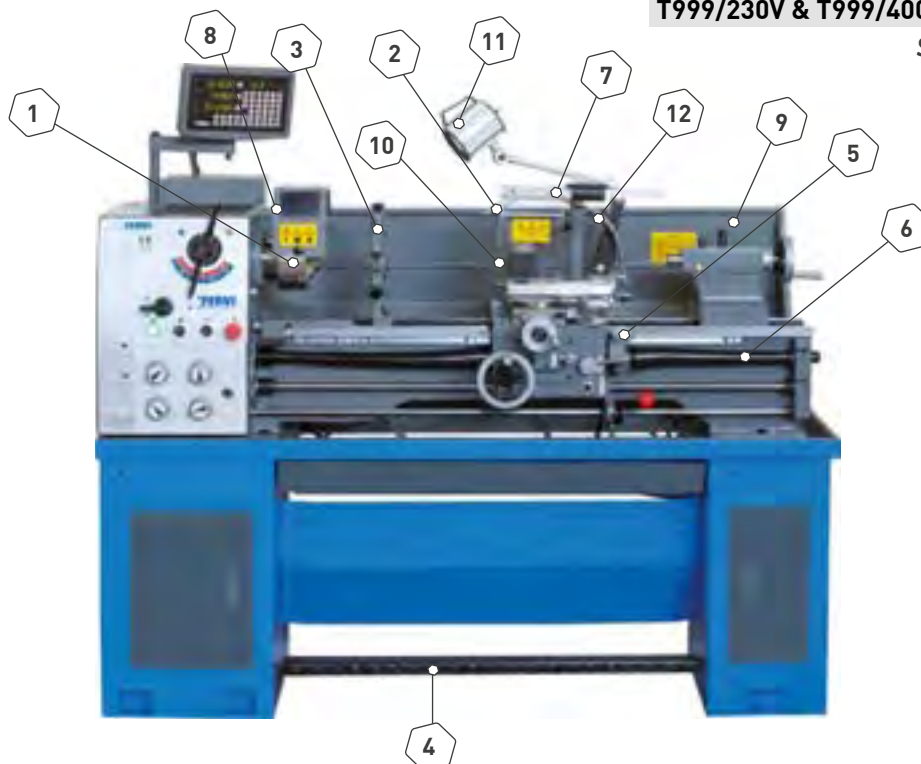
SENZA VISUALIZZATORE

1 Mandrino autocentrante 3+3 Ø 160 mm

2 Lunetta mobile

3 Lunetta fissa

4 Freno a pedale

5 Comparatore di filettatura

6 Protezione vite madre

7 Protezione torretta

8 Protezione mandrino

9 Paraspruzzi posteriore

10 Torretta a cambio rapido TOAE

11 Lampada LED

12 Sistema di raffreddamento

Altezza punta	160 mm
Diametro max sul banco	320 mm
Diametro max sul carro	198 mm
Diametro max sull'incavo	470 mm
Distanza tra le punte	1000 mm
Passaggio barra	38 mm
Attacco mandrino	Camlock D1-4
Conicità passaggio barra CM	5
Velocità del mandrino	(8) 70 ÷ 2000 rpm
Avanzamenti longitudinali	0,052 ÷ 1,392 mm / giro
Avanzamenti trasversali	0,009 ÷ 0,253 mm/giro
Filettature metriche	0,4 ÷ 7 mm
Filettature in pollici	4 ÷ 56 TPI
Conicità contropunta CM	3
Motore	230 V 50 Hz 1,8 kW 400 V 50 Hz 1,5 kW
Dimensioni	1820 x 800 x 1320 h mm
Peso netto	625 kg

ACCESSORI INCLUSI

- Mandrino autocentrante 3+3 Ø 160 mm
- Mandrino a 4 griffe indipendenti reversibili Ø 200 mm
- Bussola di riduzione CM 5/3
- Flangia menabrida Ø 250 mm
- Lunetta mobile
- Lunetta fissa
- 2x Contropunta fissa CM 3
- Contropunta rotante CM 3
- Freno a pedale elettromeccanico
- Comparatore di filettatura
- Protezione vite madre
- Protezione torretta
- Protezione mandrino
- Paraspruzzi posteriore
- Torretta a cambio rapido TOAE
- Lampada
- Sistema di raffreddamento
- Frizione su barra di tornitura
- Carrello contropunta a bloccaggio rapido
- Ingranaggi del carro a bagno d'olio



T940/230VI3A FERVIPlus

€ 10170,00

TORNIO PARALLELO CON INVERTER E VISUALIZZATORE

Scatola ingranaggi semi norton e visualizzatore a 3 assi. Barra di tornitura con frizione registrabile e visualizzatore della velocità di rotazione

**T940/230VI € 8830,00
SENZA VISUALIZZATORE**



- 1 **Mandrino autocentrante 3+3 Ø160 mm**
- 2 **Lunetta mobile**
- 3 **Lunetta fissa**
- 4 **Freno a pedale**
- 5 **Comparatore di filettatura**

- 6 **Protezione vite madre**
- 7 **Protezione torretta**
- 8 **Protezione mandrino**
- 9 **Paraspruzzi posteriore**
- 10 **Torretta a cambio rapido T0AE**
- 11 **Lampada**

Altezza punta	160 mm
Diametro max sul banco	340 mm
Diametro max sul carro	180 mm
Diametro max sull'incavo	460 mm
Distanza tra le punte	940 mm
Passaggio barra	38 mm
Attacco mandrino	Camlock D1-4
Conicità passaggio barra CM	5
Velocità variabile del mandrino	65÷ 1750 rpm
Avanzamenti longitudinali	0,053 ÷ 1,291 mm / giro
Avanzamenti trasversali	0,011 ÷ 0,276 mm/giro
Filettature metriche	0,4 ÷ 7 mm
Filettature in pollici	4 ÷ 60 TPI
Conicità contropunta CM	3
h utensile	16 mm
Motore	230 V 50/60 Hz 1.5 kW
Dimensioni	1770 x 1400 x 670 mm
Peso netto	530 kg

ACCESSORI INCLUSI

- Mandrino autocentrante 3+3 Ø 200 mm
- Piattaforma a 4 griffe indipendenti Ø 200 mm con perni
- Bussola di riduzione CM 5/3
- Flangia menabrida Ø 240 mm
- Lunetta mobile
- Lunetta fissa
- Contropunta fissa CM 3
- Contropunta fissa CM 5
- Contropunta rotante CM 3
- Freno a pedale elettromeccanico
- Comparatore di filettatura
- Protezione vite madre
- Protezione torretta
- Protezione mandrino
- Paraspruzzi posteriore
- Torretta a cambio rapido T0AE
- Lampada LED
- Carrello contropunta a bloccaggio rapido
- Ingranaggi del carro a bagno d'olio



T940/230V & T940/400V

€ 7480,00

TORNIO PARALLELO

Scatola ingranaggi semi norton

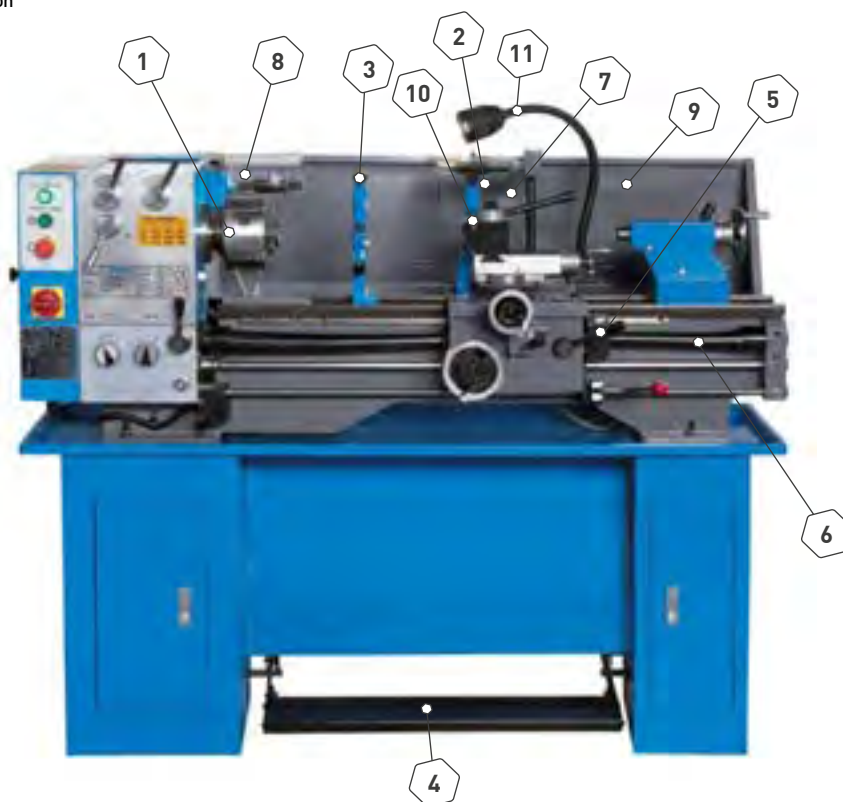
**1** Mandrino autocentrante 3+3 Ø 160 mm**2** Lunetta mobile**3** Lunetta fissa**4** Freno a pedale**5** Comparatore di filettatura**6** Protezione vite madre**7** Protezione torretta**8** Protezione mandrino**9** Paraspruzzi posteriore**10** Torretta a cambio rapido TOAE**11** Lampada

Altezza punte	150 mm
Diametro max sul banco	300 mm
Diametro max sull'incavo	480 mm
Diametro max sul carro	173 mm
Distanza tra le punte	940 mm
Passaggio barra	38 mm
Conicità passaggio barra CM	5
Velocità del mandrino	(9) 64 ÷ 1500 rpm
Avanzamenti longitudinali	0,051 ÷ 0,303 mm / giro
Avanzamenti trasversali	0,051 ÷ 0,303 mm/giro
Filettature metriche	0,5 ÷ 3,5 mm
Filettature in pollici	7,5 ÷ 48 TPI
Conicità contropunta CM	3
Motore	230 V 50 Hz 1,5 kW 400 V 50 Hz 1,1 kW
h utensile	16 mm
Dimensioni	600 x 1600 x 1270 h mm
Peso netto	520 kg

ACCESSORI INCLUSI

- Mandrino autocentrante 3+3 Ø 160 mm
- Mandrino a 4 griffe indipendenti reversibili Ø 200 mm
- Bussola di riduzione CM 5/3
- Flangia menabrida Ø 240 mm
- Flangia Ø 200 mm
- Lunetta mobile
- Lunetta fissa
- Contropunta fissa CM 3
- Contropunta fissa CM 5
- Contropunta rotante CM 3
- Freno a pedale
- Comparatore di filettatura
- Protezione vite madre
- Protezione torretta
- Protezione mandrino
- Paraspruzzi posteriore
- Torretta a cambio rapido TOAE
- Lampada a LED
- Carrello contropunta a bloccaggio rapido
- Ingranaggi del carro a bagno d'olio



TORNI

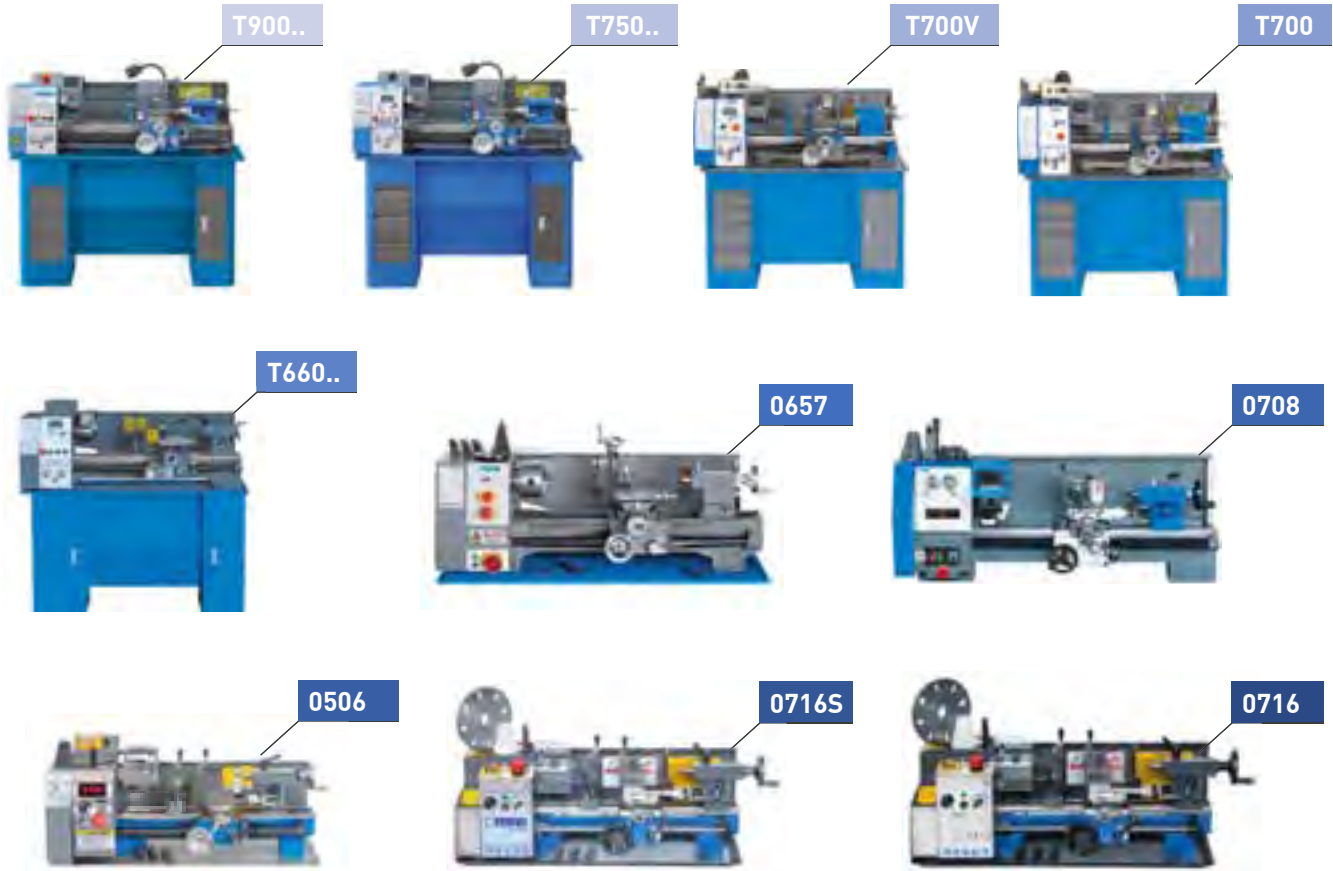

Diametro mandrino (mm)

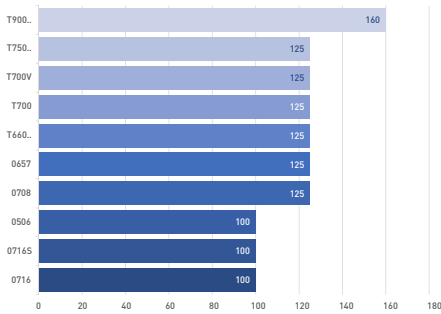

Potenza (W)

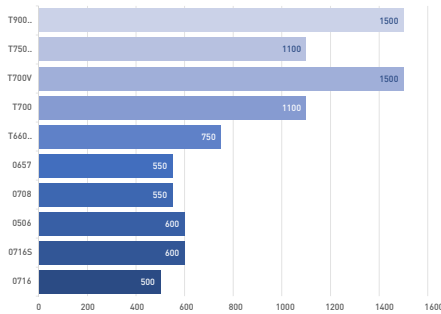

Diametro max sul carro (mm)

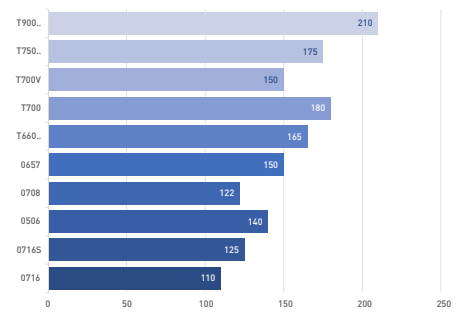

Altezza punte (mm)

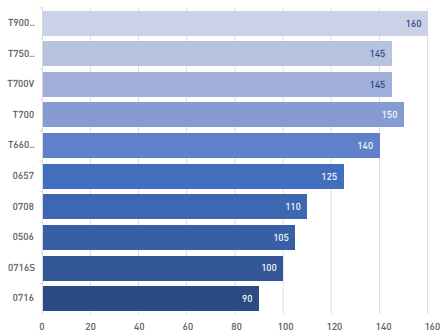

Distanza punte (mm)

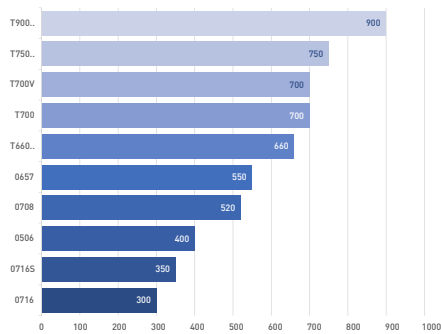

Passaggio barra (mm)

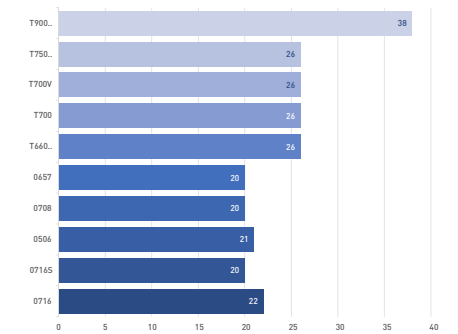

T900I

€ 7060,00

TORNIO PARALLELO CON INVERTER

Con scatola ingranaggi semi norton, trasmissione a cinghia, avanzamenti longitudinali, trasversali, barra di tornitura, banco parzialmente, assemblato con 3 cassette e armadietto. Barra di tornitura con frizione registrabile.

ACCESSORI INCLUSI

- Mandrino autocentrante 3+3 Ø 160 mm
- Mandrino a 4 griffe indipendenti reversibili Ø 160 mm
- Flangia menabrida Ø 240 mm
- Flangia per mandrino a 4 griffe Ø 160 mm
- Lunetta mobile
- Lunetta fissa
- Contropunta fissa CM 3
- Contropunta fissa CM 5
- Frizione su barra di tornitura
- Comparatore di filettatura
- Protezione vite madre
- Protezione torretta con micro di sicurezza
- Protezione mandrino con micro di sicurezza
- Paraspruzzi posteriore
- Torretta a cambio rapido T0AE
- Lampada a LED
- Carrello contropunta a bloccaggio rapido e corsa di 75 mm
- Ingranaggi del carro a bagno d'olio

Altezza punte	160 mm
Diametro max sul banco	320 mm
Diametro max sul carro	210 mm
Distanza tra le punte	900 mm
Passaggio barra	38 mm
Attacco mandrino	Camlock D1-4
Conicità passaggio barra CM	5
Velocità variabile del mandrino	75 ÷ 500 300 ÷ 2000 rpm
Avanzamenti longitudinali	0,07 ÷ 1,0 mm / giro
Avanzamenti trasversali	0,0017 ÷ 0,25 mm/giro
Filettature metriche	(18) 0,2 ÷ 3,5 mm
Filettature in pollici	(21) 8 ÷ 56 TPI
Conicità contropunta CM	3
h utensile	16 mm
Motore	230V 50/60 Hz 1.5 kW
Dimensioni	1600 x 750 x 1300 mm
Peso netto	360 kg

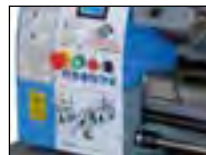
**T900**

€ 5960,00

TORNIO PARALLELO

Con scatola ingranaggi semi norton, cambio velocità a cinghia, avanzamenti longitudinali, trasversali, barra di tornitura, banco parzialmente, assemblato con 3 cassette e armadietto. Barra di tornitura con frizione registrabile.

ACCESSORI INCLUSI

- Mandrino autocentrante 3+3 Ø 160 mm
- Mandrino a 4 griffe indipendenti reversibili Ø 160 mm
- Flangia menabrida Ø 240 mm
- Flangia per mandrino a 4 griffe Ø 160 mm
- Lunetta mobile
- Lunetta fissa
- Contropunta fissa CM 3
- Contropunta fissa CM 5
- Frizione su barra di tornitura
- Comparatore di filettatura
- Protezione vite madre
- Protezione torretta con micro di sicurezza
- Protezione mandrino con micro di sicurezza
- Paraspruzzi posteriore
- Torretta a cambio rapido T0AE
- Lampada a LED
- Carrello contropunta a bloccaggio rapido e corsa di 75 mm
- Ingranaggi del carro a bagno d'olio

Altezza punte	160 mm
Diametro max sul banco	320 mm
Diametro max sul carro	210 mm
Distanza tra le punte	900 mm
Passaggio barra	38 mm
Attacco mandrino	Camlock D1-4
Conicità passaggio barra CM	5
Velocità del mandrino	(6) 125 ÷ 2000 rpm
Avanzamenti longitudinali	0,07 ÷ 1,0 mm / giro
Avanzamenti trasversali	0,0017 ÷ 0,25 mm/giro
Filettature metriche	(18) 0,2 ÷ 3,5 mm
Filettature in pollici	(21) 8 ÷ 56 TPI
Conicità contropunta CM	3
h utensile	16 mm
Motore	230 V 50 Hz 1,5 kW
Dimensioni	1600 x 750 x 1300 mm
Peso netto	330 kg



T750I
€ 6400,00
TORNIO PARALLELO CON INVERTER

Con scatola ingranaggi semi norton, trasmissione a cinghia, avanzamenti longitudinali, trasversali, barra di tornitura, banco parzialmente, assemblato con 3 cassette e armadietto. Barra di tornitura con frizione registrabile.

ACCESSORI INCLUSI

- Mandrino autocentrante 3+3 Ø 125 mm
- Mandrino a 4 griffe indipendenti reversibili Ø 160 mm
- Flangia menabrida Ø 200 mm
- Flangia per mandrino a 4 griffe Ø 160 mm
- Lunetta mobile
- Lunetta fissa
- Contropunta fissa CM 3
- Contropunta fissa CM 5
- Frizione su barra di tornitura
- Comparatore di filettatura
- Protezione vite madre
- Protezione torretta
- Protezione mandrino
- Paraspruzzi posteriore
- Torretta a cambio rapido T0AE
- Lampada a LED

Altezza punta	145 mm
Diametro max sul banco	290 mm
Diametro max sul carro	175 mm
Distanza tra le punte	750 mm
Passaggio barra	26 mm
Conicità passaggio barra CM	4
Velocità variabile del mandrino	75 ÷ 500 300 ÷ 2000 rpm
Avanzamenti longitudinali	0,07 ÷ 1,0 mm / giro
Avanzamenti trasversali	0,0017 ÷ 0,25 mm/giro
Filettature metriche	(18) 0,2 ÷ 3,5 mm
Filettature in pollici	(21) 8 ÷ 56 TPI
Conicità contropunta CM	3
Motore	Trifase 230 V 1.1 kW
Alimentazione monofase	230 V 50 / 60 Hz
Dimensioni	1450 x 720 x 1280 mm
Peso netto	310 kg

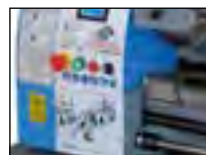

T750
€ 5310,00
TORNIO PARALLELO

Con scatola ingranaggi semi norton, cambio velocità a cinghia, avanzamenti longitudinali, trasversali, barra di tornitura, banco parzialmente, assemblato con 3 cassette e armadietto. Barra di tornitura con frizione registrabile.

ACCESSORI INCLUSI

- Mandrino autocentrante 3+3 Ø 125 mm
- Mandrino a 4 griffe indipendenti reversibili Ø 160 mm
- Flangia menabrida Ø 200 mm
- Flangia per mandrino a 4 griffe Ø 160 mm
- Lunetta mobile
- Lunetta fissa
- Contropunta fissa CM 3
- Contropunta fissa CM 5
- Frizione su barra di tornitura
- Comparatore di filettatura
- Protezione vite madre
- Protezione torretta
- Protezione mandrino
- Paraspruzzi posteriore
- Torretta a cambio rapido T0AE
- Lampada LED
- Carrello contropunta a bloccaggio rapido
- Ingranaggi del carro a bagno d'olio

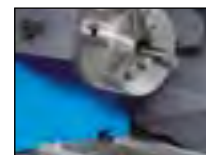
Altezza punta	145 mm
Diametro max sul banco	290 mm
Diametro max sul carro	175 mm
Distanza tra le punte	750 mm
Passaggio barra	26 mm
Conicità passaggio barra CM	4
Velocità del mandrino	(6) 125 ÷ 2000 rpm
Avanzamenti longitudinali	0,07 ÷ 1,0 mm / giro
Avanzamenti trasversali	0,0017 ÷ 0,25 mm/giro
Filettature metriche	(18) 0,2 ÷ 3,5 mm
Filettature in pollici	(21) 8 ÷ 56 TPI
Conicità contropunta CM	3
Motore	230 V 50 Hz 1,5 kW
Dimensioni	1450 x 720 x 1280 mm
Peso netto	310 kg



T700V

€ 5390,00

TORNIO PARALLELO A VELOCITÀ VARIABILE

Scatola ingranaggi semi norton, cambio a velocità variabile, avanzamenti longitudinali, trasversali, barra di tornitura, banco parzialmente, assemblato con 3 cassette e armadietto. Barra di tornitura con frizione registrabile.

ACCESSORI INCLUSI

- Mandrino autocentrante 3+3 Ø 125 mm
- Mandrino a 4 griffe indipendenti reversibili Ø 125 mm
- Flangia menabrida Ø 200 mm
- Flangia per mandrino a 4 griffe Ø 125 mm
- Lunetta mobile
- Lunetta fissa
- Contropunta fissa CM 2
- Contropunta fissa CM 4
- Frizione su barra di tornitura
- Comparatore di filettatura
- Protezione vite madre
- Protezione torretta
- Protezione mandrino
- Paraspruzzi posteriore
- Torretta fissa per utensili da 12 mm
- Carrello contropunta a bloccaggio rapido
- Ingranaggi del carro a bagno d'olio

Altezza punta	145 mm
Diametro max sul banco	290 mm
Diametro max sul carro	150 mm
Distanza tra le punte	700 mm
Passaggio barra	26 mm
Conicità passaggio barra CM	4
Velocità variabile del mandrino	50 ÷ 1000 rpm 110 ÷ 2000 rpm
Avanzamenti longitudinali	0,07 ÷ 0,65 mm / giro
Avanzamenti trasversali	0,03 ÷ 0,12 mm/giro
Filettature metriche	0,2 ÷ 3,5 mm
Filettature in pollici	8 ÷ 56 TPI
Conicità contropunta CM	2
Motore	230 V 50 Hz 1,5 kW
Dimensioni	1129 x 690 x 1127 mm
Peso netto	270 kg

**T700**

€ 4670,00

TORNIO PARALLELO

Con scatola ingranaggi semi norton, cambio velocità a cinghia, avanzamenti longitudinali, trasversali, barra di tornitura, banco parzialmente, assemblato con 3 cassette e armadietto. Barra di tornitura con frizione registrabile.

ACCESSORI INCLUSI

- Mandrino autocentrante 3+3 Ø 125 mm
- Mandrino a 4 griffe indipendenti reversibili Ø 125 mm
- Flangia menabrida Ø 200 mm
- Flangia per mandrino a 4 griffe Ø 125 mm
- Lunetta mobile
- Lunetta fissa
- Contropunta fissa CM 2
- Contropunta fissa CM 4
- Frizione su barra di tornitura
- Comparatore di filettatura
- Protezione vite madre
- Protezione torretta
- Protezione mandrino
- Paraspruzzi posteriore
- Torretta fissa per utensili da 12 mm
- Carrello contropunta a bloccaggio rapido
- Ingranaggi del carro a bagno d'olio

Altezza punta	150 mm
Diametro max sul banco	290 mm
Diametro max sul carro	180 mm
Distanza tra le punte	700 mm
Passaggio barra	26 mm
Conicità passaggio barra CM	4
Velocità del mandrino	(6) 150 ÷ 2000 rpm
Avanzamenti longitudinali	0,085 ÷ 0,832 mm / giro
Avanzamenti trasversali	0,01 ÷ 0,10 mm / giro
Filettature metriche	0,2 ÷ 3,5 mm
Filettature in pollici	8 ÷ 48 TPI
Conicità contropunta CM	2
Motore	230 V 50 Hz 1.1 kW
Dimensioni	1270 x 610 x 1320 h mm
Peso netto	270 kg



T660I

€ 5550,00

TORNIO PARALLELO CON INVERTER A VELOCITÀ VARIABILE

Scatola ingranaggi semi norton, banco parzialmente assemblato

ACCESSORI INCLUSI

- Mandrino autocentrante 3+3 Ø 125 mm
- Mandrino a 4 griffe indipendenti reversibili Ø 160 mm
- Flangia menabrida Ø 200 mm
- Flangia per mandrino a 4 griffe Ø 160 mm
- Lunetta mobile
- Lunetta fissa
- Contropunta fissa CM 2
- Contropunta fissa CM 4
- Contropunta rotante CM 2
- Comparatore di filettatura
- Protezione vite madre
- Protezione torretta
- Protezione mandrino
- Paraspruzzi posteriore
- Torretta a cambio rapido T0AA

Altezza punte	140 mm
Diametro max sul banco	280 mm
Diametro max sul carro	165 mm
Distanza tra le punte	660 mm
Passaggio barra	26 mm
Conicità passaggio barra CM	4
Velocità variabile del mandrino	100 ÷ 2000 rpm
Avanzamenti longitudinali	0,063 ÷ 0,35 mm / giro
Filettature metriche	0,25 ÷ 3,5 mm
Filettature in pollici	8 ÷ 72 TPI
Conicità contropunta CM	2
Motore	230 V 50/60 Hz 0.75 kW
Dimensioni	1325 x 550 x 1230 mm
Peso netto	216 kg

T660

€ 4150,00

TORNIO PARALLELO

Scatola ingranaggi semi norton e cambio velocità a cinghia, banco parzialmente assemblato

ACCESSORI INCLUSI

- Mandrino autocentrante 3+3 Ø 125 mm
- Mandrino a 4 griffe indipendenti reversibili Ø 160 mm
- Flangia menabrida Ø 200 mm
- Flangia per mandrino a 4 griffe Ø 160 mm
- Lunetta mobile
- Lunetta fissa
- Contropunta fissa CM 2
- Contropunta fissa CM 4
- Contropunta rotante CM 2
- Comparatore di filettatura
- Protezione vite madre
- Protezione mandrino
- Paraspruzzi posteriore
- Torretta a cambio rapido T0AA

Altezza punte	140 mm
Diametro max sul banco	280 mm
Diametro max sul carro	165 mm
Distanza tra le punte	660 mm
Passaggio barra	26 mm
Conicità passaggio barra CM	4
Velocità del mandrino	(6) 125 ÷ 2000 rpm
Avanzamenti longitudinali	0,063 ÷ 0,35 mm / giro
Filettature metriche	0,25 ÷ 3,5 mm
Filettature in pollici	8 ÷ 72 TPI
Conicità contropunta CM	2
Motore	230 V 50 Hz 0,75 kW
Dimensioni	1325 x 550 x 1230 mm
Peso netto	216 kg

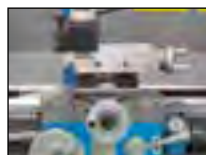

0657

€ 2850,00

TORNIO PARALLELO

Con dispositivo di fresatura, cambio velocità a cinghia

ACCESSORI INCLUSI

- Mandrino autocentrante 3+3 Ø 125 mm
- Contropunta fissa CM 2
- Contropunta fissa CM 3
- Protezione vite madre
- Protezione torretta
- Protezione mandrino
- Paraspruzzi posteriore
- Torretta fissa per utensili da 12 mm
- Carrello contropunta a bloccaggio rapido

Altezza punta	125 mm
Diametro max sul banco	250 mm
Diametro max sul carro	150 mm
Distanza tra le punte	550 mm
Passaggio barra	20 mm
Conicità passaggio barra CM	3
Conicità contropunta CM	2
Velocità del mandrino	(6) 125 ÷ 2000 rpm
Avanzamenti longitudinali	0,1 - 0,2 mm / giro
Filettature metriche	0,4 ÷ 3,5 mm
Filettature in pollici	18 ÷ 44 TPI
Motore	230 V 50 Hz 0,55 kW
Dimensioni	1120 x 480 x 460h mm
Peso netto	145 kg



0708

€ 2330,00

TORNIO PARALLELO

Con cambio di velocità ad ingranaggi, cuscinetti conici dell'albero mandrino, noni registrabili, vite madre protetta e protezione mandrino con microinterruttore

ACCESSORI INCLUSI

- Mandrino autocentrante 3+3 Ø 125 mm
- Lunetta mobile
- Contropunta fissa CM2
- Contropunta fissa CM3
- Comparatore per filettare
- Protezione vite madre
- Protezione torretta
- Protezione mandrino
- Paraspruzzi posteriore
- Torretta fissa per utensili da 12 mm

Altezza punta	110 mm
Diametro max sul banco	200 mm
Diametro max sul carro	122 mm
Distanza tra le punte	520 mm
Passaggio barra	20 mm
Conicità passaggio barra CM	3
Velocità del mandrino	(6) 170 ÷ 1950 rpm
Avanzamenti longitudinali	0,04 ÷ 0,20 mm / giro
Filettature metriche	0,25 ÷ 3 mm
Filettature in pollici	8 ÷ 48 TPI
Conicità contropunta CM	2
Motore	230 V 50 Hz 0,55 kW
Dimensioni	1080 x 440 x 400h mm
Peso netto	130 kg



0506

€ 2120,00

TORNIO PARALLELO

Con avanzamenti automatici longitudinale e velocità' variabile visualizzata sul display digitale. Ingranaggi in metallo

ACCESSORI INCLUSI

- Mandrino autocentrante 3+3 Ø 100 mm
- Lunetta mobile
- Lunetta fissa
- Contropunta fissa CM 2
- Contropunta rotante CM 2
- Comparatore per filettare
- Protezione torretta
- Protezione mandrino in metallo
- Protezione vite madre
- Paraspruzzi posteriore
- Torretta fissa per utensili da 10 mm
- Carrello contropunta a bloccaggio rapido

Altezza punta	105 mm
Diametro max sul banco	210 mm
Diametro max sul carro	140 mm
Distanza tra le punte	400 mm
Passaggio barra	21 mm
Conicità passaggio barra CM	3
Velocità variabile del mandrino	50 ÷ 1100 rpm 100 ÷ 2500 rpm
Avanzamenti longitudinali	0,083 ÷ 0,175 mm / giro
Filettature metriche	(9) 0,5 ÷ 2,5 mm
Conicità contropunta CM	2
Motore	230 V 50 Hz 0,6 kW
Dimensioni	780 x 300 x 340 h mm
Peso netto	49 kg

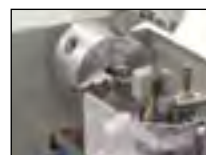

0716S
€ 1870,00
TORNIO PARALLELO

Con avanzamenti automatici longitudinale e velocità' variabile visualizzata sul display digitale

ACCESSORI INCLUSI

- Mandrino autocentrante 3+3 Ø 100 mm
- Flangia Ø 125 mm
- Lunetta mobile
- Lunetta fissa
- Contropunta fissa CM 2
- Comparatore per filettare
- Protezione torretta
- Protezione mandrino
- Paraspruzzi posteriore
- Torretta fissa per utensili da 10 mm

Altezza punta	100 mm
Diametro max sul banco	170 mm
Diametro max sul carro	125 mm
Distanza tra le punte	350 mm
Passaggio barra	20 mm
Conicità passaggio barra CM	3
Velocità variabile del mandrino	(2) 100 ÷ 1100 200 ÷ 2500 rpm
Filettature metriche	0,5 ÷ 2,5 mm
Conicità contropunta CM	2
Motore	230 V 50 Hz 0,6 kW
Dimensioni	750 x 245 x 290 h mm
Peso netto	46 kg

0716
€ 1680,00
TORNIO PARALLELO

Con avanzamenti automatici longitudinali e velocità' variabile visualizzata su display digitale

ACCESSORI INCLUSI

- Mandrino autocentrante 3+3 Ø 100 mm
- Flangia Ø 125 mm
- Lunetta mobile
- Lunetta fissa
- Contropunta fissa CM 2
- Comparatore per filettare
- Protezione torretta
- Protezione mandrino
- Paraspruzzi posteriore
- Torretta fissa per utensili da 10 mm

Altezza punta	90 mm
Diametro max sul banco	170 mm
Diametro max sul carro	110 mm
Distanza tra le punte	300 mm
Passaggio barra	22 mm
Conicità passaggio barra CM	3
Velocità del mandrino	(2) 100 ÷ 1100 200 ÷ 2500 rpm
Filettature metriche	0,5 ÷ 2,5 mm / giro
Conicità contropunta CM	2
Motore	230 V 50 Hz 0,5 kW
Dimensioni	730 x 290 x 280 h mm
Peso netto	40 kg

0657/B
€ 446,00
BANCO PER TORNIO

Banco per tornio da assemblare



Dimensioni	1050 x 433 x 720h mm
Peso netto	36,5 kg

0710
€ 327,00
BASE PER TORNIO

Base per tornio parzialmente assemblato



Dimensioni	1050 x 320 x 725h mm
Peso netto	21 kg

0716/B
€ 308,00
BASE PER TORNIO

Completamente in lamiera, chiusura senza chiave, con mensola interna.



Dimensioni	760 x 240 x 680h mm
Interasse fori	475 x 70 mm
Altezza mensola interna	405 mm
Peso netto	24,00 kg



TRAPANI FRESA



F060/..



F050/..



T073



T047/..



T044/..



T052/..



T046



T045



T059/28V



T059/16V



T061A



T058



TRAPANI FRESA

Capacità di foratura su ghisa con preforo (mm)

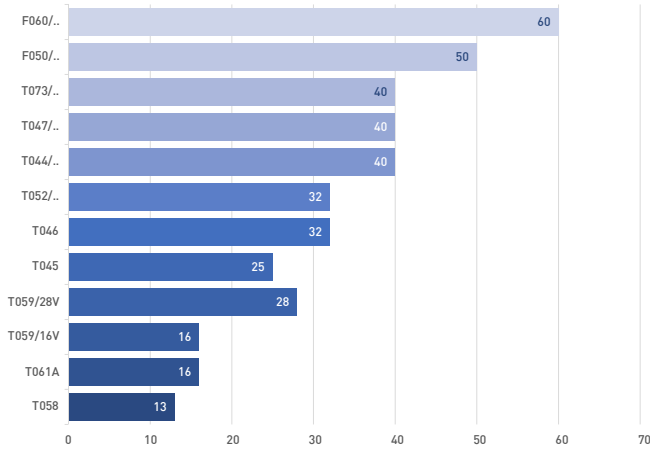

Capacità di fresatura (mm)

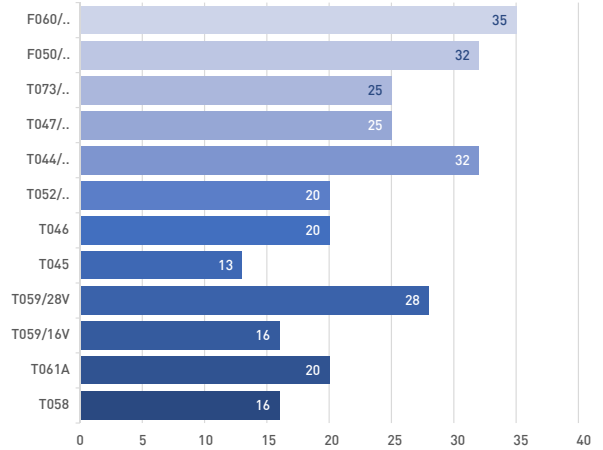

Corsa mandrino (mm)

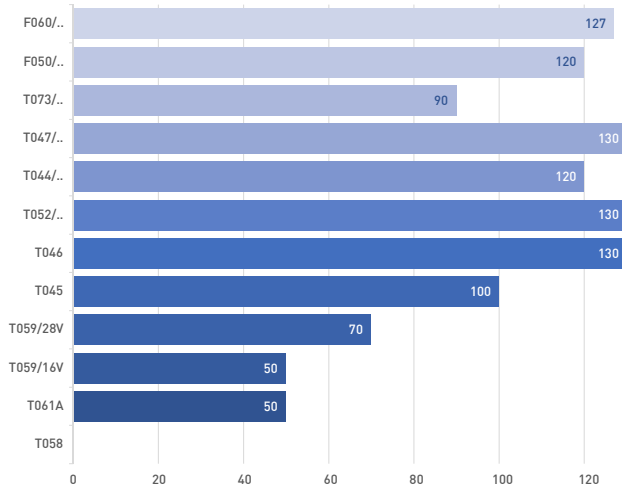

Attacco

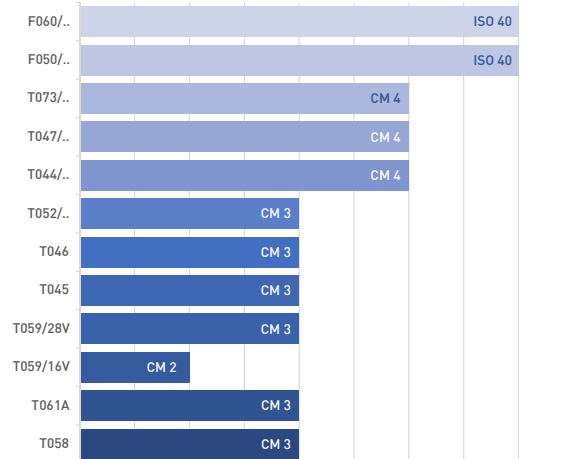

Dimensioni tavola (mm)

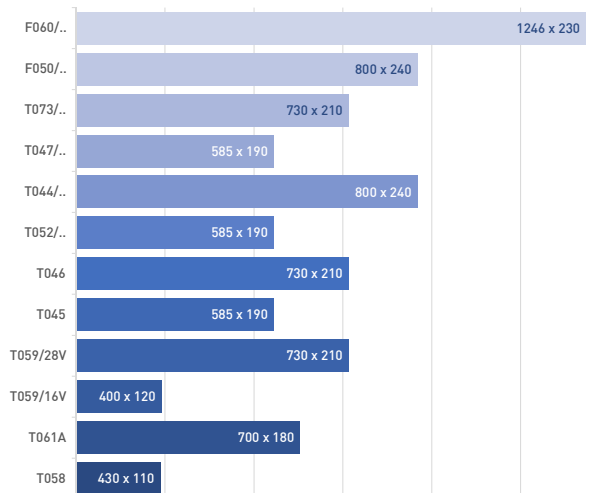

Potenza (W)

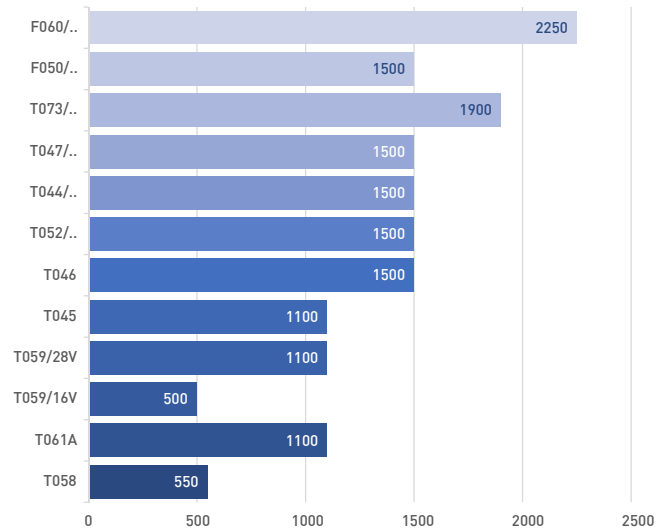

F060I

€ 23620,00

FRESA VERTICALE A TESTA VELOCE CON INVERTER

ISO 40, tavola a croce motorizzata su tutti gli assi, visualizzatore a 3 assi e inverter giapponese.

ACCESSORI INCLUSI

- Base con vasca per trucioli
- Impianto di refrigerazione
- Lampada a LED
- Display per la visualizzazione della velocità di rotazione
- Visualizzatore a 3 assi
- Assi motorizzati a velocità variabile con funzione rapido
- Volantini tavola tondi con funzione di folle
- Impianto di lubrificazione delle guide con pompa manuale

Capacità di fresatura con fresa a inserti	100 mm
Capacità di fresatura	35 mm
Capacità di foratura su ghisa con preforo	60 mm
Capacità max di foratura su acciaio con preforo (s235jr)	24 mm
Attacco mandrino	ISO 40 - DIN 2080
Canotto	86 mm
Corsa mandrino	127 mm
Inclinazione testa	± 45°
Rotazione testa verticale	± 90°
Rotazione corpo testa	± 180°
Velocità variabile del mandrino	60 ÷ 3600 rpm
Motore	400 V 50 Hz 2.25 kW
Motore movimentazione tavola	110V 50Hz 0.3 KW
Pompa di refrigerazione	400V 50 Hz 0.4 KW
Distanza tra naso macchina e tavola	45 - 395 mm
Distanza asse mandrino - colonna	215-450 mm
Dimensioni tavola	1246 x 230 mm
Spostamento tavola longitudinale	850 mm
Spostamento tavola trasversale	310 mm
Cava	16 mm
Dimensioni	1680 x 1500 x 2100 h mm
Peso netto	1000 kg

F060V

€ 20610,00

FRESA VERTICALE CON TESTA VELOCE CON VARIATORE VELOCITÀ MECCANICO

A velocità variabile, ISO 40, tavola a croce motorizzata su tutti gli assi, visualizzatore a 3 assi.

ACCESSORI INCLUSI

- Base con vasca per trucioli
- Impianto di refrigerazione
- Lampada a LED
- Indicatore meccanico della velocità
- Visualizzatore a 3 assi
- Assi motorizzati a velocità variabile con funzione rapido
- Volantini tavola tondi con funzione di folle
- Impianto di lubrificazione delle guide con pompa manuale

Capacità di fresatura con fresa a inserti	100 mm
Capacità di fresatura	35 mm
Capacità di foratura su ghisa con preforo	60 mm
Capacità max di foratura su acciaio con preforo (s235jr)	24 mm
Attacco mandrino	ISO40 DIN2080
Canotto	86 mm
Corsa mandrino	120 mm
Inclinazione testa	± 45°
Rotazione testa verticale	± 90°
Rotazione corpo testa	± 180°
Velocità mandrino verticale	[2] 60 ÷ 500 [500 ÷ 3600 rpm]
Motore	400 V 50 Hz 2.25 kW
Motore movimentazione tavola	110V 50Hz 0.3 KW
Pompa di refrigerazione	400V 50 Hz 0.4 KW
Distanza tra naso macchina e tavola	45 - 395 mm
Distanza asse mandrino - colonna	215-450 mm
Dimensione tavola	1246 x 230 mm
Spostamento tavola longitudinale	850 mm
Spostamento tavola trasversale	310 mm
Cava	16 mm
Dimensioni	1680 x 1500 x 2100 h mm
Peso netto	1000 kg



F060

€ 18650,00

FRESA A TESTA VELOCE VERTICALE

ISO40, tavola a croce motorizzata su tutti gli assi, visualizzatore a 3 assi, cambio a cinghie

ACCESSORI INCLUSI

- Base con vasca per trucioli
- Impianto di refrigerazione
- Lampada a LED
- Visualizzatore a 3 assi
- Assi motorizzati a velocità variabile con funzione rapido
- Volantini tavola tondi con funzione di folle
- Impianto di lubrificazione delle guide con pompa manuale

Capacità di fresatura con fresa a inserti	100 mm
Capacità di fresatura	35 mm
Capacità di foratura su ghisa con preforo	60 mm
Capacità max di foratura su acciaio con preforo [s235jr]	24 mm
Attacco mandrino	ISO40 DIN2080
Canotto	86 mm
Corsa mandrino	120 mm
Inclinazione testa	±45°
Rotazione testa verticale	±90°
Rotazione corpo testa	± 180°
Velocità mandrino verticale	(2) 80 ÷ 650 660 ÷ 5440 rpm
Motore	400 V 50 Hz 2,25 kW
Motore movimentazione tavola	110V 50Hz 0.3 KW
Pompa di refrigerazione	400V 50 Hz 0.4 KW
Distanza tra naso macchina e tavola	45 - 395 mm
Distanza asse mandrino - colonna	215-450 mm
Dimensione tavola	1246 x 230 mm
Spostamento tavola longitudinale	850 mm
Spostamento tavola trasversale	310 mm
Cava	16 mm
Dimensioni	1680 x 1500 x 2100 h mm
Peso netto	1000 kg

**F050U**

€ 12800,00

FRESA UNIVERSALE A TESTA VELOCE

Fresatura verticale e orizzontale, ISO 40, tavola a croce con un asse motorizzato, visualizzatore a 3 assi. Cambio ad ingranaggi per mandrino verticale e cambio a cinghie per mandrino orizzontale.

ACCESSORI INCLUSI

- Base con vasca per trucioli
- Impianto di refrigerazione
- Lampada a LED
- Visualizzatore a 3 assi
- Morsa a macchina 160mm
- Mandrino ISO40 con pinze ER32 8 Pz
- Mandrino ISO40 CM 3
- Mandrino a cremagliera 3-16mm B18
- Albero mandrino ISO40 B18
- 2 mandrini portafresa per asse orizzontale
- 2 tiranti M16 per mandrini ISO40
- Asse longitudinale motorizzato ad ingranaggi con rapido
- Volantini tavola tondi con funzione di folle

Capacità di fresatura con fresa a inserti	100 mm
Capacità di fresatura	32 mm
Capacità di foratura su ghisa con preforo	50 mm
Capacità max di foratura su acciaio con preforo [s235jr]	30 mm
Attacco mandrino	ISO40 DIN2080
Canotto	90 mm
Corsa mandrino	120 mm
Rotazione testa verticale	± 45°
Rotazione corpo testa	± 180°
Velocità mandrino verticale	(8) 115 ÷ 1750 rpm
Velocità mandrino orizzontale	(9) 60 ÷ 1350 rpm
Motore	400 V 50 Hz 0.85 - 1.5 kW
Motore movimentazione tavola	400V 50Hz 0.325 KW
Dimensioni base	510 x 900 mm
Pompa di refrigerazione	400V 50 Hz 0.4 KW
Distanza tra naso macchina e tavola	60 - 360 mm
Distanza asse mandrino - colonna	250 - 650 mm
Dimensioni tavola	800 x 240 mm
Spostamento tavola longitudinale	380 mm
Spostamento tavola trasversale	220 mm
Cava	14 mm
Dimensioni	1380 x 1200 x 2100 h mm
Peso netto	930 kg



F050I

€ 14090,00

FRESA A TESTA VELOCE CON INVERTER

Inverter giapponese, fresatura verticale, ISO 40, tavola a croce con un asse motorizzato, visualizzatore a 3 assi.

ACCESSORI INCLUSI

- Base con vasca per trucioli
- Impianto di refrigerazione
- Lampada a LED
- Visualizzatore a 3 assi
- Morsa a macchina 160mm
- Mandrino ISO40 con pinze ER32 8Pz
- Mandrino ISO40 CM3
- Mandrino a cremagliera 3-16mm B18
- Albero mandrino ISO40 B18
- 2 tiranti M16 per mandrini ISO40
- Asse longitudinale motorizzato ad ingranaggi con rapido
- Volantini tavola tondi con funzione di folle

Capacità di fresatura con fresa a inserti	100 mm
Capacità di fresatura	32 mm
Capacità di foratura su ghisa con preforo	50 mm
Capacità max di foratura su acciaio con preforo (s235jr)	30 mm
Attacco mandrino	ISO40 DIN2080
Canotto	90 mm
Corsa mandrino	120 mm
Rotazione testa verticale	± 180°
Rotazione corpo testa	± 90°
Velocità variabile del mandrino	[2] 100 ÷ 600 [350 ÷ 2000 rpm
Motore	400 V 50 Hz 2,2 kW
Motore movimentazione tavola	400V 50Hz 0.325 KW
Dimensioni base	510 x 900 mm
Pompa di refrigerazione	400V 50 Hz 0.4 KW
Distanza asse mandrino - colonna	60 - 360 mm
Distanza naso macchina-tavola	250 - 650 mm
Dimensioni tavola	800 x 240 mm
Spostamento tavola longitudinale	380 mm
Spostamento tavola trasversale	220 mm
Cava	14 mm
Dimensioni	1380 x 1200 x 2100
Peso netto	930 kg

F050

€ 11740,00

FRESA A TESTA VELOCE

Fresatura verticale, ISO 40, tavola a croce con un asse motorizzato, visualizzatore a 3 assi.

ACCESSORI INCLUSI

- Base con vasca per trucioli
- Impianto di refrigerazione
- Lampada a LED
- Visualizzatore a 3 assi
- Morsa a macchina 160mm
- Mandrino ISO40 con pinze ER32 8 Pz
- Mandrino ISO40 CM3
- Mandrino a cremagliera 3 - 16 mm B18
- Albero mandrino ISO40 B18
- 2 tiranti M16 per mandrini ISO40
- Asse longitudinale motorizzato ad ingranaggi con rapido
- Volantini tavola tondi con funzione di folle

Capacità di fresatura con fresa a inserti	100 mm
Capacità di fresatura	32 mm
Capacità di foratura su ghisa con preforo	50 mm
Capacità max di foratura su acciaio con preforo (s235jr)	30 mm
Attacco mandrino	ISO40 DIN2080
Canotto	90 mm
Corsa mandrino	120 mm
Rotazione testa verticale	± 45°
Rotazione corpo testa	± 180°
Velocità variabile del mandrino	[8] 115 - 1750 rpm
Motore	400 V 50 Hz 0,85 - 1,5 kW
Motore movimentazione tavola	400V 50Hz 0.325 KW
Dimensioni base	510 x 900 mm
Pompa di refrigerazione	400V 50 Hz 0.4 KW
Distanza tra naso macchina e tavola	60 - 360 mm
Distanza asse mandrino - colonna	250 - 650 mm
Dimensioni tavola	800 x 240 mm
Spostamento tavola longitudinale	380 mm
Spostamento tavola trasversale	220 mm
Cava	14 mm
Dimensioni	1380 x 1200 x 2100
Peso netto	930 kg



T047/400VDA

€ 5070,00

TRAPANO FRESA AD INGRANAGGI

Con discesa automatica, inversione di marcia, maschiatura, impianto di refrigerazione

ACCESSORI INCLUSI

- Mandrino autoserrante 1 ÷ 13 B16
- Attacco mandrino forato CM 4 B16
- Attacco fresa CM 4 Ø 27 mm
- Bussola di riduzione CM 4/3
- Bussola di riduzione CM 3/2
- Oliatori
- Tirante M16
- Chiavi di servizio

Capacità di foratura su ghisa con preforo	Ø 40 mm
Capacità di foratura su acciaio con preforo	Ø 32 mm
Capacità di fresatura con fresa a inserti	Ø 80 mm
Capacità di fresatura	Ø 25 mm
Capacità di maschiatura	Ø 22 mm
Cono morse	CM 4
Mandrino	1 - 16mm B16
Velocità del mandrino	(12) 75 ÷ 3200 rpm
Corsa mandrino	130 mm
Rotazione mandrino	Dx - Sx
Canotto	Ø 76 mm
Colonna	Ø 115 mm
Inclinazione testa	± 60°
Divisione avanzamento verticale manuale	0.02 mm
Velocità di discesa	(3) 0,1 - 0,18 - 0,26 mm/g
Distanza tra naso macchina e tavola	715 mm
Distanza asse mandrino - colonna	260 mm
Dimensioni tavola	585 x 190 mm
Cava	14 mm
Corsa longitudinale	360 mm
Corsa trasversale	250 mm
Spostamento tavola longitudinale	360 mm
Spostamento tavola trasversale	250 mm
Dimensioni base	648 x 412 mm
Motore	400 V 50 Hz 1,1 - 1,5 kW
Dimensioni	740 x 790 x 1960 h mm
Peso netto	365 kg

**T047/230V & T047/400V**

€ 4750,00

TRAPANO FRESA AD INGRANAGGI

Con inversione di marcia, maschiatura temporizzata, impianto di refrigerazione

ACCESSORI INCLUSI

- Mandrino autoserrante 1 ÷ 13 B16
- Attacco mandrino forato CM 4 B16
- Attacco fresa CM 4 Ø 27 mm
- Bussola di riduzione CM 4/3
- Bussola di riduzione CM 3/2
- Oliatori
- Tirante M16
- Chiavi di servizio

Capacità di foratura su ghisa con preforo	Ø 40 mm
Capacità di foratura su acciaio con preforo	Ø 32 mm
Capacità di fresatura con fresa a inserti	Ø 80 mm
Capacità di fresatura con fresa cilindrica	Ø 25 mm
Capacità di maschiatura	Ø 22 mm
Cono morse	CM 4
Velocità del mandrino	(6) 75 ÷ 1600 rpm (12) 75 ÷ 3200 rpm
Corsa mandrino	130 mm
Rotazione mandrino	Dx - Sx
Canotto	Ø 76 mm
Colonna	Ø 115 mm
Inclinazione testa	± 60°
Divisione avanzamento verticale manuale	0.02 mm
Distanza asse mandrino - colonna	260 mm
Distanza tra naso macchina e tavola	715 mm
Dimensioni tavola	585 x 190 mm
Cava	12 mm
Spostamento tavola longitudinale	360 mm
Spostamento tavola trasversale	250 mm
Dimensioni base	648 x 412 mm
Motore	230 V 50 Hz 1,5 kW 400 V 50 Hz 1,1 - 1,5 kW
Pompa di refrigerazione	230v 50 Hz 0.4 KW 400v 50 Hz 0.4 KW
Dimensioni	740 x 790 x 1960h mm
Peso netto	355 kg



T044/230V & T044/400V

€ 4540,00

TRAPANO FRESA DA BANCO AD INGRANAGGI

Colonna quadra e guide a coda di rondine, inversione di marcia temporizzata, maschiatura

ACCESSORI INCLUSI

- Mandrino a cremagliera 1 ÷ 16 B16
- Attacco mandrino forato CM 4 B16
- Attacco fresa CM 4 Ø 27 mm
- Bussola di riduzione CM 4/3
- Bussola di riduzione CM 3/2
- Oliatori
- Tirante M16
- Chiavi di servizio

Capacità di foratura su ghisa con preforo	Ø 40 mm
Capacità max di foratura su acciaio con preforo (s235jr)	Ø 45 mm
Capacità di fresatura con fresa a inserti	Ø 80 mm
Capacità di fresatura con fresa cilindrica	Ø 32 mm
Capacità di maschiatura	Ø 22 mm
Cono morse	CM 4
Mandrino	1 - 16 mm B16
Velocità del mandrino	(6) 95 ÷ 1600 rpm
Corsa mandrino	120 mm
Rotazione mandrino	Dx - Sx
Canotto	Ø 75 mm
Inclinazione testa	± 60°
Divisione avanzamento verticale manuale	0,02 mm
Distanza asse mandrino - colonna	240 mm
Distanza max asse mandrino - tavola	460 mm
Dimensione tavola	800 x 240 mm
Cava	14 mm
Spostamento tavola longitudinale	560 mm
Spostamento tavola trasversale	190 mm
Dimensioni base	405 x 630 mm
Motore	230 V 50 Hz 1,5 kW 400 V 50 Hz 1,5 kW
Peso netto	300 kg

T059/28V

€ 4050,00

TRAPANO FRESA DA BANCO AD INGRANAGGI

A velocità variabile con visualizzatore digitale di velocità mandrino e visualizzatore digitale di profondità

ACCESSORI INCLUSI

- Mandrino a cremagliera 1 ÷ 13 B16
- Attacco mandrino forato CM 3 B16
- Oliatore
- Tirante M12
- Chiavi di servizio



Capacità max di foratura su acciaio con preforo (s235jr)	Ø 28 mm
Capacità di fresatura con fresa a inserti	Ø 63 mm
Capacità di fresatura con fresa cilindrica	Ø 28 mm
Cono morse	CM 3
Mandrino	1 - 13 mm B16
Velocità del mandrino	100 ÷ 2500 rpm ±10%
Rotazione mandrino	Dx - Sx
Corsa del canotto	70 mm
Canotto	70 mm
Corsa testa	380 mm
Inclinazione testa	±90°
Dimensione tavola	730 x 210 mm
Cava	14 mm
Spostamento tavola longitudinale	190 mm
Spostamento tavola trasversale	440 mm
Motore	230 V 50 Hz 1,1 kW
Peso netto	270 kg



T061A

€ 3150,00

TRAPANO FRESA DA BANCO AD INGRANAGGI

A velocità variabile, con sistema di illuminazione, visualizzatore digitale di velocità mandrino, visualizzatore digitale di profondità

Capacità max di foratura su acciaio con preforo [s235jr]	Ø 16 mm
Capacità di fresatura con fresa a inserti	Ø 63 mm
Capacità di fresatura con fresa cilindrica	Ø 20 mm
Cono morse	CM 3
Mandrino	1 - 16 mm B16
Velocità variabile del mandrino	I 30 ÷ 1650 rpm ±10% II 2° 40 ÷ 2850 rpm ±10%
Corsa del canotto	50 mm
Rotazione mandrino	Dx - Sx
Canotto	50 mm
Corsa testa	290 mm
Inclinazione testa	±90°
Distanza naso macchina-tavola	350 mm
Dimensione tavola	700 x 180 mm
Cava	12 mm
Spostamento tavola longitudinale	175 mm
Spostamento tavola trasversale	490 mm
Motore	230 V 50 Hz 1,1 kW
Peso netto	120 kg

ACCESSORI INCLUSI

- Mandrino a cremagliera 1 ÷ 16 B16
- Attacco mandrino forato CM 3
- Oliatore
- Tirante M12
- Chiavi di servizio

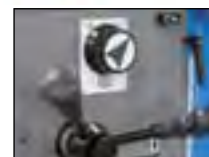
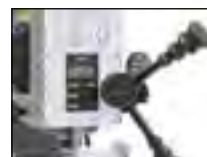
**T059/16V**

€ 2110,00

TRAPANO FRESA DA BANCO AD INGRANAGGI

A velocità variabile

ACCESSORI INCLUSI

- Mandrino a cremagliera 1 ÷ 13 B16
- Attacco mandrino forato CM 2 B16
- Oliatore
- Tirante M10
- Chiavi di servizio

Capacità max di foratura su acciaio con preforo [s235jr]	Ø 16 mm
Capacità di fresatura con fresa a inserti	Ø 50 mm
Capacità di fresatura con fresa cilindrica	Ø 16 mm
Cono morse	CM 2
Mandrino	1 - 13 mm B16
Velocità del mandrino	I 100 ÷ 1500 rpm ±10% II 200 ÷ 3000 rpm ±10%
Corsa del canotto	50 mm
Rotazione mandrino	Dx
Corsa testa	210 mm
Inclinazione testa	±90°
Dimensione tavola	400 x 120 mm
Cava	10 mm
Spostamento tavola longitudinale	160 mm
Spostamento tavola trasversale	220 mm
Motore	230 V 50 Hz 500 W
Peso netto	72 kg

**T058**

€ 1700,00

TRAPANO FRESA DA BANCO AD INGRANAGGI

A velocità variabile

ACCESSORI INCLUSI

- Mandrino a cremagliera 3 ÷ 16 B16
- Attacco mandrino forato CM 3
- Oliatore
- Tirante M12
- Chiavi di servizio

Capacità max di foratura su acciaio con preforo [s235jr]	Ø 13 mm
Capacità di fresatura con fresa a inserti	Ø 30 mm
Capacità di fresatura con fresa cilindrica	Ø 16 mm
Cono morse	CM 3
Mandrino	3 - 16 mm B16
Velocità del mandrino	I 50 ÷ 1100 rpm ±10% II 120 ÷ 2500 rpm ±10%
Rotazione mandrino	Dx
Corsa testa	210 mm
Inclinazione testa	±45°
Dimensione tavola	430 x 110 mm
Distanza tavola naso macchina	290 mm
Cava	12 mm
Spostamento tavola longitudinale	130 mm
Spostamento tavola trasversale	250 mm
Motore	230 V 50 Hz 0,55 kW
Peso netto	70 kg



T073DA

€ 9540,00

TRAPANO FRESA A COLONNA

Con trasmissione a cinghia, discesa automatica, reversibile, sistema di refrigerazione.

ACCESSORI INCLUSI

- Mandrino a cremagliera 1 ÷ 13 mm B16
- Attacco mandrino CM 4 B16
- Attacco fresa CM 4 Ø 27 mm
- Bussola di riduzione CM 4/3
- Bussola di riduzione CM 3/2
- Impianto di refrigerazione
- Tirante M16
- Chiavi di servizio

Capacità di foratura su ghisa con preforo	40 mm
Capacità max di foratura su acciaio con preforo [s235jr]	32 mm
Capacità di fresatura con fresa a inserti	80 mm
Capacità di fresatura	25 mm
Capacità di maschiatura	24 mm
Cono morse	CM 4
Mandrino	1 - 13 mm B16
Velocità del mandrino	100 - 2200 rpm
Corsa mandrino	90 mm
Rotazione mandrino	Dx - Sx
Canotto	75 mm
Colonna	123 mm
Divisione avanzamento verticale manuale	0,05 mm
Velocità di discesa	{3} 0,05 - 0,1 - 0,2 mm/g
Distanza asse mandrino - colonna	300 mm
Distanza tra naso macchina e tavola	125 ÷ 525 mm
Dimensione tavola	730 x 210 mm
Cava	14 mm
Spostamento tavola longitudinale	480 mm
Spostamento tavola trasversale	220 mm
Dimensioni base	470 x 680 mm
Motore	400 V 50 Hz 1,1 / 1,9 kW
Pompa di refrigerazione	400 V 50 Hz 0.9 KW
Dimensioni	850 x 1100 x 1900h mm
Peso netto	420 kg

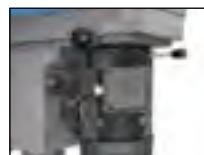
T073

€ 7770,00

TRAPANO FRESA A COLONNA

Con trasmissione a cinghia, reversibile, sistema di refrigerazione.

ACCESSORI INCLUSI

- Mandrino a cremagliera 1 ÷ 13 mm B16
- Attacco mandrino CM 4 B16
- Attacco fresa CM 4 Ø 27 mm
- Bussola di riduzione CM 4/3
- Bussola di riduzione CM 3/2
- Impianto di refrigerazione
- Tirante M16
- Chiavi di servizio

Capacità di foratura su ghisa con preforo	40 mm
Capacità max di foratura su acciaio con preforo [s235jr]	32 mm
Capacità di fresatura con fresa a inserti	80 mm
Capacità di fresatura	25 mm
Capacità di maschiatura	24 mm
Cono morse	CM 4
Mandrino	1 - 13 mm B16
Velocità del mandrino	100 ÷ 2200 rpm
Corsa mandrino	130 mm
Rotazione mandrino	Dx - Sx
Canotto	75 mm
Colonna	123 mm
Divisione avanzamento verticale manuale	0,05 mm
Distanza asse mandrino - colonna	300 mm
Distanza tra naso macchina e tavola	125 ÷ 525 mm
Dimensione tavola	730 x 210 mm
Cava	14 mm
Spostamento tavola longitudinale	480 mm
Spostamento tavola trasversale	220 mm
Dimensioni base	470 x 680 mm
Motore	400 V 50 Hz 1,1/1,9 kW
Pompa di refrigerazione	400 V 50 Hz 90 W
Dimensioni	850 x 1100 x 1900h mm
Peso netto	410 kg



T052/400VDA

€ 4590,00

TRAPANO FRESA A COLONNA

Con discesa automatica, scelta senso di rotazione e trasmissione a cinghia

ACCESSORI INCLUSI

- Mandrino a cremagliera 1 ÷ 16 B16
- Attacco mandrino forato CM 3
- Attacco fresa CM 3 Ø 27 mm
- Bussola di riduzione CM 3/2
- Impianto di refrigerazione
- Oliatori
- Tirante M12
- Chiavi di servizio

Capacità max di foratura su acciaio con preforo (s235jr)	32 mm
Capacità di fresatura con fresa a inserti	80 mm
Capacità di fresatura	20 mm
Cono morse	CM 3
Mandrino	1 - 13 mm B16
Velocità del mandrino	125 ÷ 2500 rpm
Corsa mandrino	130 mm
Rotazione mandrino	Dx - Sx
Canotto	75 mm
Colonna	115 mm
Corsa testa	405 mm
Divisione avanzamento verticale manuale	0,05 mm
Velocità di discesa	0,12 - 0,18 - 0,25 mm/g
Distanza asse mandrino - colonna	197 mm
Distanza tra naso macchina e tavola	600 mm
Dimensione tavola	585 x 190 mm
Cava	12 mm
Spostamento tavola longitudinale	180 mm
Spostamento tavola trasversale	380 mm
Dimensioni base	470 x 670 mm
Motore	400 V 50 Hz 1,5 kW
Pompa di refrigerazione	400v 50 Hz 0.4 KW
Dimensioni	928 x 910 x 1700h mm
Peso netto	310 kg

**T052/400V**

€ 3950,00

TRAPANO FRESA A COLONNA

Con scelta senso di rotazione e trasmissione a cinghia

ACCESSORI INCLUSI

- Mandrino a cremagliera 1 ÷ 13 B16
- Attacco mandrino forato CM 3 B16
- Bussola di riduzione CM 3/2
- Impianto di refrigerazione
- Oliatori
- Tirante M12
- Chiavi di servizio

Capacità max di foratura su acciaio con preforo (s235jr)	32 mm
Capacità di fresatura con fresa a inserti	80 mm
Capacità di fresatura	20 mm
Cono morse	CM 3
Mandrino	1 - 13 mm B16
Velocità del mandrino	125 ÷ 2500 rpm
Corsa mandrino	130 mm
Rotazione mandrino	Dx - Sx
Colonna	115 mm
Canotto	75 mm
Corsa testa	405 mm
Divisione avanzamento verticale manuale	0,05 mm
Distanza asse mandrino - colonna	197 mm
Distanza tra naso macchina e tavola	600 mm
Dimensione tavola	585 x 190 mm
Cava	12 mm
Spostamento tavola longitudinale	180 mm
Spostamento tavola trasversale	380 mm
Dimensioni base	470 x 670 mm
Motore	400 V 50 Hz 1,5 kW
Pompa di refrigerazione	400v 50 Hz 0.4 KW
Dimensioni	928 x 910 x 1700h mm
Peso netto	300 kg



T046
€ 3420,00
TRAPANO FRESA DA BANCO

Con scelta senso di rotazione e trasmissione a cinghia

Capacità max di foratura su acciaio con preforo (s235jr)	32 mm
Capacità di fresatura con fresa a inserti	80 mm
Capacità di fresatura	20 mm
Cono morse	CM 3
Mandrino	1 - 13 mm B16
Velocità del mandrino	100 ÷ 2080 rpm
Corsa mandrino	130 mm
Rotazione mandrino	Dx - Sx
Canotto	75 mm
Colonna	115 mm
Corsa testa	405 mm
Divisione avanzamento verticale manuale	0,05 mm
Distanza asse mandrino - colonna	200 mm
Distanza tra naso macchina e tavola	457 mm
Dimensione tavola	730 x 210 mm
Cava	14 mm
Spostamento tavola longitudinale	175 mm
Spostamento tavola trasversale	500 mm
Motore	230 V 50 Hz 1,5 kW
Dimensioni base	400 x 600 mm
Peso netto	250 kg

ACCESSORI INCLUSI

- Mandrino a cremagliera 1 ÷ 13 B16
- Attacco mandrino forato CM 3 B16
- Attacco fresa CM 3 Ø 27 mm
- Bussola di riduzione CM 3/2
- Oliatori
- Tirante M12
- Chiavi di servizio

T045
€ 2770,00
TRAPANO FRESA DA BANCO

Con scelta del senso di rotazione e trasmissione a cinghia

Capacità max di foratura su acciaio con preforo (s235jr)	25 mm
Capacità di fresatura con fresa a inserti	63 mm
Capacità di fresatura	13 mm
Cono morse	CM 3
Mandrino	1 - 13 mm B16
Velocità del mandrino	90 ÷ 2150 rpm
Corsa mandrino	100 mm
Rotazione mandrino	Dx
Canotto	62 mm
Colonna	92 mm
Corsa testa	400 mm
Divisione avanzamento verticale manuale	0,03 mm
Distanza asse mandrino - colonna	200 mm
Distanza tra naso macchina e tavola	380 mm
Dimensione tavola	585 x 190 mm
Cava	14 mm
Spostamento tavola longitudinale	160 mm
Spostamento tavola trasversale	370 mm
Dimensioni base	310 x 500 mm
Motore	230 V 50 Hz 1,1 kW
Peso netto	195 kg

ACCESSORI INCLUSI

- Mandrino a cremagliera 1 ÷ 13 B16
- Attacco mandrino forato CM 3 B16
- Attacco fresa CM 3 Ø 22 mm
- Bussola di riduzione CM 3/2
- Oliatori
- Tirante M12
- Chiavi di servizio

0599
€ 384,00
BANCO UNIVERSALE PER TRAPANI FRESA

Con vano porta attrezzi e serratura

Dimensioni base	415 x 625 x 750h mm
Dimensioni vasca	615 x 820 x 30h mm
Dimensioni fondo vasca	530 x 735 mm
Portata	400 kg
Peso netto	59 kg





TRAPANO RADIALE



Dimensioni tavola (mm)

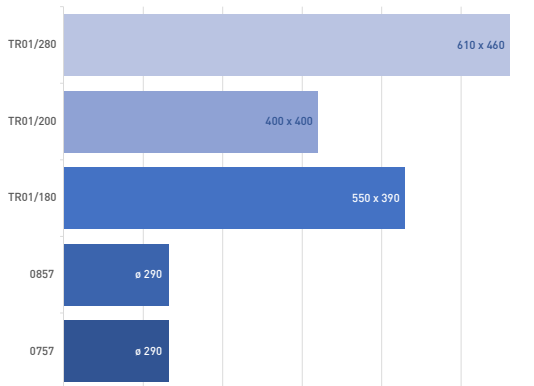

CM

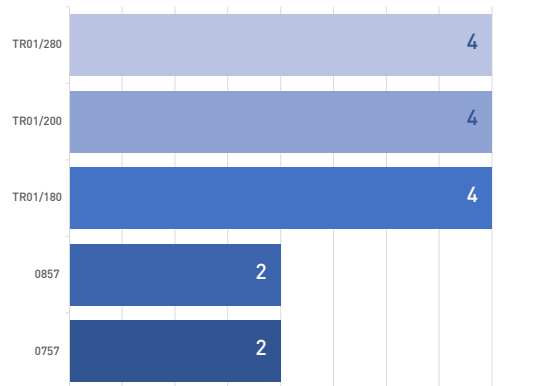

Corsa mandrino (mm)

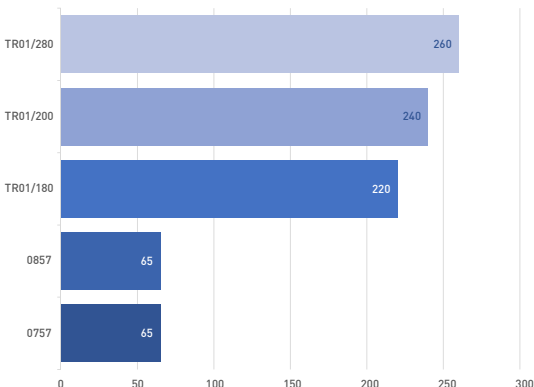

Diametro colonna (mm)

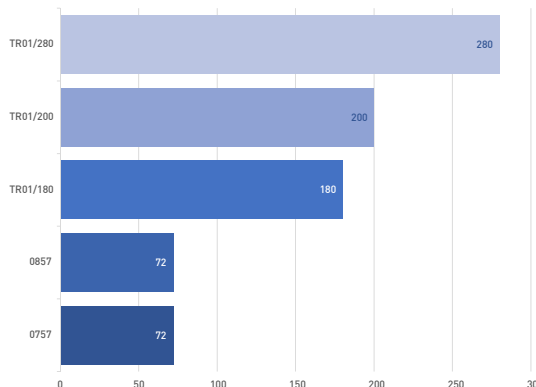

TR01/280 **FERVIplus**

NEW € 25200,00

TRAPANO RADIALE

Bloccaggio idraulico tra braccio e colonna, discesa automatica, inversione di marcia, sistema di refrigerazione, Dotato di illuminazione Led. Con cambio di velocità ad ingranaggi

- 1 Salita motorizzata
- 2 Illuminazione
- 3 Cubo
- 4 Discesa automatica

ACCESSORI INCLUSI

- Mandrino a cremagliera 3 ÷ 13 mm B18
- Attacco mandrino forato su acciaio (s235jr)
- Bussola di riduzione CM 4/3
- Bussola di riduzione CM 3/2
- Lampada a LED
- Impianto di refrigerazione
- Cubo base

Capacità di foratura su ghisa con preforo	Ø 50 mm
Capacità max di foratura su acciaio con preforo (s235jr)	Ø 40 mm
Capacità di foratura continua	Ø 40 mm
Cono morse	CM 4
Mandrino	
Velocità del mandrino	(12) 40 ÷ 1896 rpm
Corsa mandrino	260 mm
Canotto	Ø 67 mm
Colonna	280 mm
Distanza asse mandrino - colonna	1370 mm
Distanza tra naso macchina e tavola	840 mm
Distanza tra naso macchina e base	1210 mm
Velocità di discesa	(4) 0.13 ÷ 0.54 mm/g
Dimensioni cubo	610 x 460 x 370 mm
Cava	16 mm 20 mm
Dimensioni base	1960 x 800 mm
Motore	400 V 50 Hz 3,0 kW
Motore di sollevamento braccio radiale	400 V 50 Hz 750 W
Pompa di refrigerazione	400 V 50 Hz 90 W
Dimensioni	2050 x 820 x 2480 mm
Peso netto	2100 kg

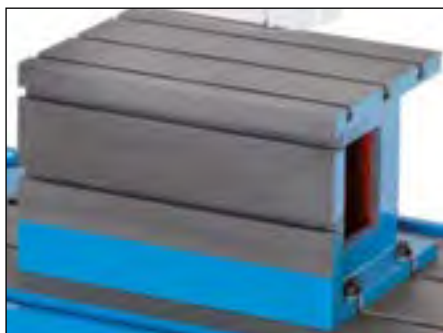

TR01/200

€ 17450,00

TRAPANO RADIALE

Discesa automatica, inversione di marcia, sistema di refrigerazione, dotato di illuminazione Led. Con cambio di velocità ad ingranaggi

- 1 **Salita motorizzata**
- 2 **Illuminazione**
- 3 **Cubo**
- 4 **Discesa automatica**

ACCESSORI INCLUSI

- Mandrino a cremagliera 3 ÷ 13 mm B18
- Attacco mandrino forato CM 4 B18
- Bussola di riduzione CM 4/3
- Bussola di riduzione CM 3/2
- Lampada a LED
- Impianto di refrigerazione
- Cubo base

Capacità di foratura su ghisa con preforo	50 mm
Capacità max di foratura su acciaio con preforo (s235jr)	40 mm
Capacità di foratura continua	36 mm
Cono morse	CM 4
Mandrino	3 ÷ 13 mm B18
Velocità del mandrino	(6) 75 ÷ 1220 rpm
Corsa mandrino	240 mm
Canotto	70 mm
Colonna	200 mm
Distanza asse mandrino - colonna	1020 mm
Distanza tra naso macchina e tavola	860 mm
Distanza tra naso macchina e base	1210 mm
Velocità di discesa	(3) 0,1 - 0,16 - 0,25 mm/g
Dimensioni cubo	400 x 400 x 350 mm
Cava	18 mm
Dimensioni base	1370 x 700 mm
Motore	400 V 50 Hz 1,5 kW
Motore di sollevamento braccio radiale	400 V 50 Hz 750 W
Pompa di refrigerazione	400 V 50 Hz 90 W
Dimensioni	1760 x 770 x 2100h mm
Peso netto	1250 kg

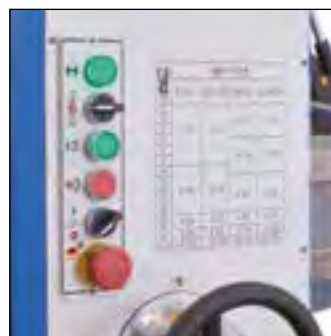

TR01/180

€ 11200,00

TRAPANO RADIALE

Discesa automatica, inversione di marcia, sistema di refrigerazione, dotato di illuminazione Led. Con cambio di velocità ad ingranaggi

- 1 Illuminazione
- 2 Cubo
- 3 Discesa automatica

ACCESSORI INCLUSI

- Mandrino a cremagliera 3 ÷ 16 mm B16
- Attacco mandrino forato CM 4 B16
- Bussola di riduzione CM 4/3
- Lampada a LED
- Impianto di refrigerazione
- Cubo base

Capacità di foratura su ghisa con preforo	40 mm
Capacità max di foratura su acciaio con preforo (s235jr)	32 mm
Capacità di foratura continua	28 mm
Cono morse	CM 4
Mandrino	3 ÷ 16 mm B16
Velocità del mandrino	(6) 75 ÷ 1220 rpm
Corsa mandrino	220 mm
Canotto	65 mm
Colonna	180 mm
Distanza asse mandrino - colonna	350 ÷ 870 mm
Distanza tra naso macchina e tavola	0 ÷ 640 mm
Distanza tra naso macchina e base	310 ÷ 980 mm
Velocità di discesa	(3) 0,1 - 0,16 - 0,25 mm/g
Dimensioni cubo	550 x 390 x 350 mm
Cava	18 mm
Dimensioni base	1300 x 650 mm
Motore	400 V 50 Hz 1,5 kW
Motore di sollevamento braccio radiale	400V 50 Hz 0,55 kW
Pompa di refrigerazione	400V 50 Hz 0,40 kW
Dimensioni	1400 x 650 x 1900 h mm
Peso netto	1050 kg



0857**€ 916,00****TRAPANO A COLONNA RADIALE CON TRASMISSIONE A CINGHIA**

Tavola girevole e inclinabile con doppio braccio, testa inclinabile, Impianto elettrico con circuito separato a 24V per i comandi bordo macchina.

ACCESSORI INCLUSI

- Mandrino Autoserrante 1 - 16 mm B16
- Attacco mandrino CM 2



Capacità di foratura su ghisa con preforo	Ø 20 mm
Capacità max di foratura su acciaio con preforo (s235jr)	Ø 16 mm
Capacità di foratura continua	Ø 12 mm
Cono morse	CM 2
Mandrino	1 - 16 mm B16
Velocità del mandrino	(12) 300 ÷ 2550 rpm
Corsa mandrino	65 mm
Canotto	Ø 40 mm
Colonna	Ø 72 mm
Spostamento radiale	280 mm
Inclinazione testa	90° Sx ; 45° Dx
Altezza	1600 mm
Distanza asse mandrino - colonna	375 mm
Distanza tra naso macchina e base	1290 mm
Dimensioni tavola	Ø 290 mm
Motore	230 V 50 Hz 0,375 kW
Dimensioni	950 x 300 x 1600 mm
Peso netto	60 kg

**0757****€ 700,00****TRAPANO DA BANCO RADIALE CON TRASMISSIONE A CINGHIA**

Tavola girevole e inclinabile con doppio braccio, testa inclinabile, Impianto elettrico con circuito separato a 24V per i comandi bordo macchina.

ACCESSORI INCLUSI

- Mandrino Autoserrante 1 - 16 mm B16
- Attacco mandrino CM 2

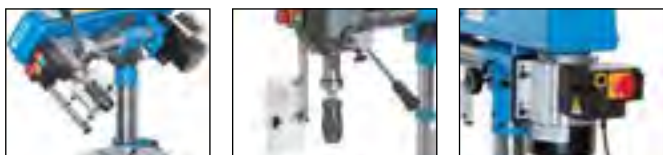

Capacità di foratura su ghisa con preforo	Ø 20 mm
Capacità max di foratura su acciaio con preforo (s235jr)	Ø 16 mm
Capacità di foratura continua	Ø 12 mm
Cono morse	CM 2
Mandrino	1 - 16 mm B16
Velocità del mandrino	(12) 300 ÷ 2550 rpm
Corsa mandrino	65 mm
Canotto	Ø 40 mm
Colonna	Ø 72 mm
Spostamento radiale	280 mm
Inclinazione testa	90° Sx ; 45° Dx
Altezza	810 mm
Distanza asse mandrino - colonna	375 mm
Distanza tra naso macchina e base	505 mm
Dimensioni tavola	Ø 290 mm
Inclinazione tavola	± 45°
Motore	230 V 50 Hz 0,375 kW
Dimensioni	950 x 300 x 810h mm
Peso netto	46 kg



TRAPANI A COLONNA

T145



T066



T062



T041/..



T072DA



T072



T032DA



T032



T071



0252/..



0754/..



0752CM3



0752



0186



TRAPANI A COLONNA

CM

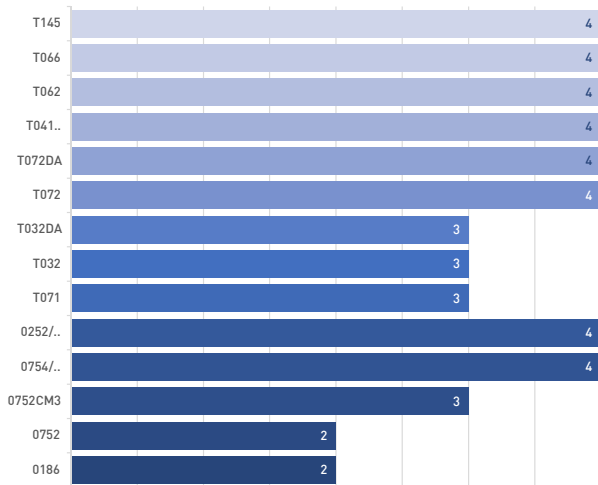

Corsa mandrino (mm)

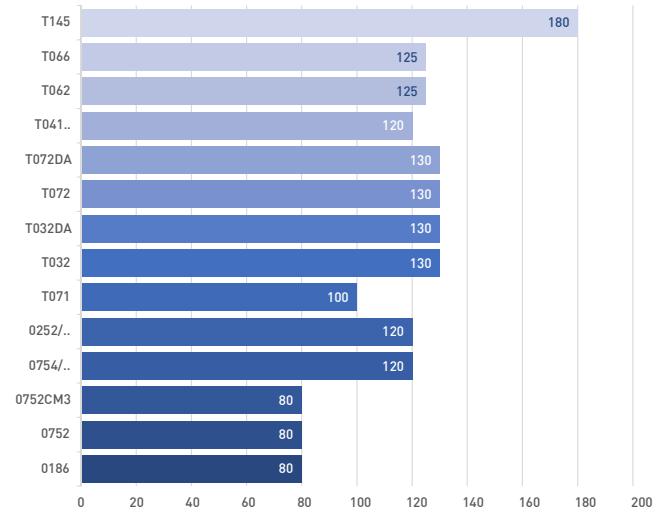

Diametro colonna (mm)

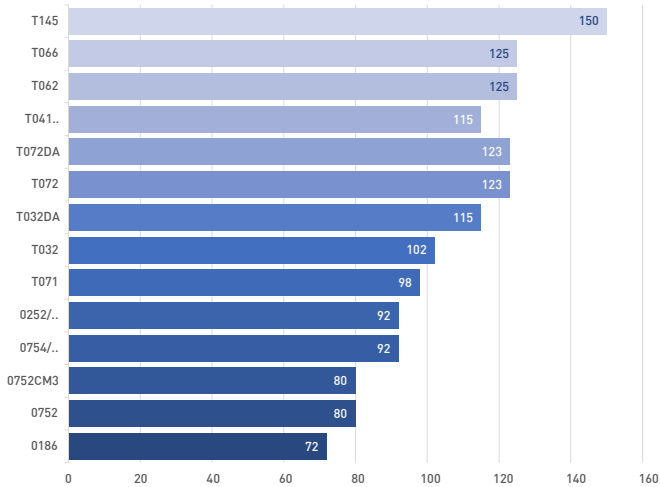

Dimensioni tavola (mm)

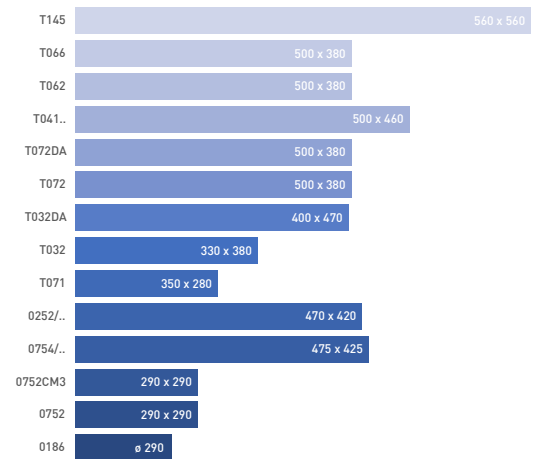

T145

€ 8500,00

TRAPANO AD INGRANAGGI

Discesa automatica, inversione di marcia, sistema di refrigerazione e illuminazione, tavola parzialmente girevole.

- 1** Motore ad induzione
- 2** Leva cambio
- 3** Protezione mandrino
- 4** Pompa di refrigerazione

ACCESSORI INCLUSI

- Mandrino a cremagliera 1 ÷ 13 mm B16
- Attacco mandrino CM 4 B16
- Bussola di riduzione CM 4/3
- Bussola di riduzione CM 3/2

Capacità di foratura su ghisa con preforo	Ø 45 mm
Capacità max di foratura su acciaio con preforo (s235jr)	Ø 40 mm
Capacità di foratura continua	Ø 35 mm
Cono morse	CM 4
Mandrino	1 ÷ 13 mm B16
Velocità del mandrino	(18) 50 ÷ 1450 rpm
Corsa mandrino	180 mm
Rotazione mandrino	Dx - Sx
Canotto	Ø 75 mm
Colonna	Ø 150 mm
Velocità di discesa	(2) 0,1 - 0,20 mm/g
Distanza asse mandrino - colonna	350 mm
Distanza tra naso macchina e tavola	780 mm
Distanza tra naso macchina e base	1320 mm
Dimensione tavola	560 x 560 mm
Cava	18 mm
Inclinazione tavola	±90°
Dimensioni base	500 x 730 mm
Motore	400 V 50 Hz 1,2 / 2,2 kW
Pompa di refrigerazione	400 V 50 Hz 40 W
Dimensioni	935 x 530 x 2280 mm
Peso netto	550 kg

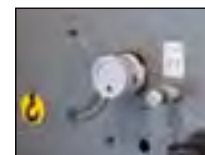
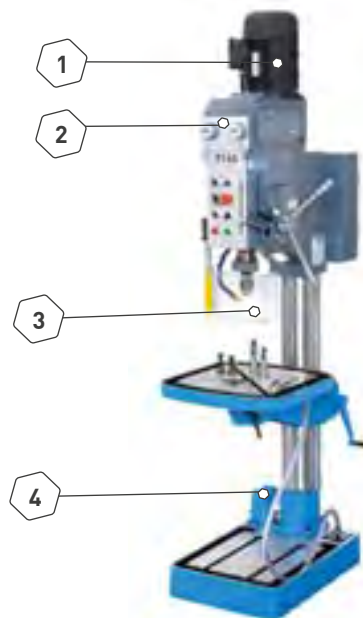
T066

€ 5760,00

TRAPANO AD INGRANAGGI

Discesa automatica, inversione di marcia, sistema di refrigerazione, tavola reversibile con morsa di 145mm, dotato di illuminazione.

- 1** Motore ad induzione
- 2** Leva cambio
- 3** Protezione mandrino
- 4** Pompa di refrigerazione

ACCESSORI INCLUSI

- Mandrino a cremagliera 1 ÷ 13 B16
- Attacco mandrino CM 4 B16
- Bussola di riduzione CM 4/3
- Bussola di riduzione CM 3/2



Capacità di foratura su ghisa con preforo	Ø 40 mm
Capacità max di foratura su acciaio con preforo (s235jr)	Ø 35 mm
Capacità di foratura continua	Ø 30mm
Cono morse	CM 4
Mandrino	1 ÷ 13 mm B16
Velocità del mandrino	(12) 75 ÷ 3200 rpm
Corsa mandrino	125 mm
Rotazione mandrino	Dx - Sx
Canotto	Ø 75 mm
Colonna	Ø 125 mm
Velocità di discesa	(3) 0,1 - 0,18 - 0,26 mm/g
Distanza asse mandrino - colonna	320 mm
Distanza tra naso macchina e tavola	80-680 mm
Distanza tra naso macchina e base	1140 mm
Dimensione tavola	500 x 380 mm
Cava	14 mm
Inclinazione tavola	±90°
Morsa	125 mm
Dimensioni base	470 x 670 mm
Motore	400 V 50 Hz 1,1/1,5 kW
Pompa di refrigerazione	400 V 50 Hz 40 W
Dimensioni	500 x 750 x 2000 mm
Peso netto	400 kg

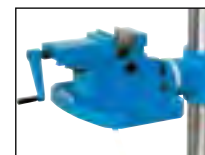
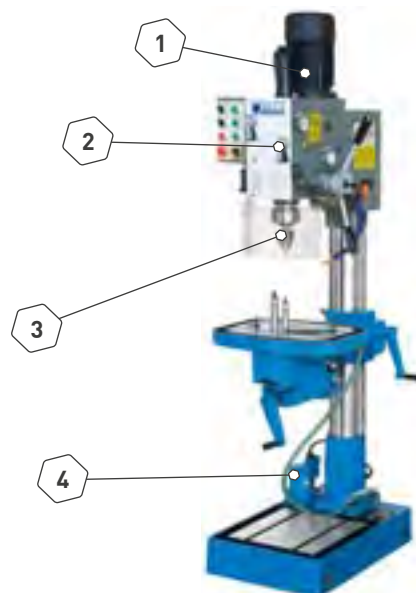

T062

€ 4840,00

TRAPANO AD INGRANAGGI

Inversione di marcia, tavola inclinabile con morsa di 145mm. Dotato di illuminazione.

- 1 **Motore ad induzione** 3 **Protezione mandrino**
 2 **Leva cambio** 4 **Tavola ribaltabile con morsa incorporata**

ACCESSORI INCLUSI

- Mandrino a cremagliera 1 ÷ 13 B16
- Attacco mandrino forato CM 4
- Bussola di riduzione CM 4/3
- Bussola di riduzione CM 3/2

Capacità di foratura su ghisa con preforo	Ø 40 mm
Capacità max di foratura su acciaio con preforo (s235jr)	Ø 35 mm
Capacità di foratura continua	Ø 30 mm
Cono morse	CM 4
Mandrino	1 ÷ 13 mm B16
Velocità del mandrino	(12) 75 ÷ 3200 rpm
Corsa mandrino	125 mm
Rotazione mandrino	Dx - Sx
Canotto	Ø 75 mm
Colonna	Ø 125 mm
Distanza asse mandrino - colonna	320 mm
Distanza tra naso macchina e tavola	80 ÷ 680 mm
Distanza tra naso macchina e base	1140 mm
Dimensioni tavola	500 x 380 mm
Cava	14 mm
Inclinazione tavola	±90°
Morsa	125 mm
Dimensioni base	460 x 650 mm
Motore	400 V 50 Hz 1,1/1,5 kW
Dimensioni	500 x 750 x 2000 mm
Peso netto	350 kg

T041DA

€ 4740,00

TRAPANO AD INGRANAGGI

Inversione di marcia, maschiatura temporizzata, discesa automatica e impianto di refrigerazione, tavola parzialmente girevole

- 1 **Motore ad induzione** 3 **Protezione mandrino**
 2 **Leva cambio** 4 **Pompa di refrigerazione**

ACCESSORI INCLUSI

- Mandrino autoserrante 1 ÷ 16 B16
- Attacco mandrino forato CM 4 B16
- Bussola di riduzione CM 4/3
- Bussola di riduzione CM 3/2

Capacità di foratura su ghisa con preforo	Ø 40 mm
Capacità max di foratura su acciaio con preforo (s235jr)	Ø 35 mm
Capacità di foratura continua	Ø 30 mm
Capacità di maschiatura	22 mm
Cono morse	CM 4
Mandrino	1 ÷ 16 B16
Velocità del mandrino	(12) 75 ÷ 3200 rpm
Corsa mandrino	120 mm
Rotazione mandrino	Dx - Sx
Inclinazione testa	±60°
Canotto	Ø 76 mm
Colonna	Ø 115 mm
Velocità di discesa	(3) 0,1 - 0,18 - 0,26 mm/g
Distanza asse mandrino - colonna	297 mm
Distanza tra naso macchina e tavola	715 mm
Distanza tra naso macchina e base	1180 mm
Dimensione tavola	500 x 460 mm
Cava	14 mm
Dimensioni base	470 x 670 mm
Motore	400 V 50 Hz 1,1/1,5 kW
Dimensioni	700 x 480 x 1850 mm
Peso netto	340 kg



T041

€ 4420,00

TRAPANO AD INGRANAGGI

Inversione di marcia, testa inclinabile e maschiatura temporizzata, tavola parzialmente girevole

- 1 **Motore ad induzione**
- 2 **Leva cambio**
- 3 **Protezione mandrino**

ACCESSORI INCLUSI

- Mandrino autoserrante 1 ÷ 16 B16
- Attacco mandrino forato CM 4 B16
- Bussola di riduzione CM 4/3
- Bussola di riduzione CM 3/2

Capacità di foratura su ghisa con preforo	Ø 40 mm
Capacità max di foratura su acciaio con preforo (s235jr)	Ø 35 mm
Capacità di foratura continua	Ø 30 mm
Capacità di maschiatura	22 mm
Cono morse	CM 4
Mandrino	1 ÷ 16 B16
Velocità del mandrino	(12) 75 - 3200 rpm
Corsa mandrino	120 mm
Rotazione mandrino	Dx - Sx
Inclinazione testa	±60°
Canotto	Ø 76 mm
Colonna	Ø 115 mm
Distanza asse mandrino - colonna	297 mm
Distanza tra naso macchina e tavola	715 mm
Distanza tra naso macchina e base	1180 mm
Dimensione tavola	500 x 460 mm
Cava	14 mm
Dimensioni base	650 x 450 x 80 mm
Motore	400 V 50 Hz 1,1/1,5 kW
Dimensioni	700 x 480 x 1820 mm
Peso netto	330 kg



T072DA **FERVIplus**

€ 7990,00

TRAPANO A COLONNA CON TRASMISSIONE A CINGHIA

Discesa automatica, inversione di marcia, sistema di refrigerazione, tavola reversibile con morsa di 140mm.

- 1 **Motore ad induzione**
- 2 **Protezione mandrino**
- 3 **Tavola ribaltabile con morsa incorporata**

ACCESSORI INCLUSI

- Mandrino a cremagliera 1 ÷ 13mm B16
- Attacco mandrino CM 4 B16
- Bussola di riduzione CM 4/3
- Bussola di riduzione CM 3/2

Capacità di foratura su ghisa con preforo	Ø 38 mm
Capacità max di foratura su acciaio con preforo (s235jr)	Ø 32 mm
Capacità di foratura continua	Ø 28 mm
Cono morse	CM 4
Mandrino	1 ÷ 13 B16
Velocità del mandrino	100 ÷ 2200 rpm
Corsa mandrino	130 mm
Canotto	75 mm
Colonna	123 mm
Divisione avanzamento verticale manuale	0,05 mm
Velocità di discesa	(3) 0,05 - 0,1 - 0,2 mm/g
Distanza tra naso macchina e tavola	300 mm
Distanza tra naso macchina e base	1220 mm
Dimensione tavola	500 x 380 mm
Cava	14 mm
Inclinazione tavola	±90°
Morsa	125 mm
Dimensioni base	460 x 670 mm
Motore	400 V 50 Hz 1,1/1,9 kW
Pompa di refrigerazione	400 V 50 Hz 90 W
Dimensioni	700 x 1100 x 1900 mm
Peso netto	385 kg



T072

€ 6460,00

TRAPANO A COLONNA CON TRASMISSIONE A CINGHIA

Inversione di marcia, tavola reversibile con morsa da 140mm, sistema di refrigerazione.

- 1 **Motore ad induzione** 3 **Tavola ribaltabile con morsa incorporata**
 2 **Protezione mandrino**

ACCESSORI INCLUSI

- Mandrino a cremagliera 1 ÷ 13mm B16
- Attacco mandrino CM 4 B16
- Bussola di riduzione CM 4/3
- Bussola di riduzione CM 3/2

Capacità di foratura su ghisa con preforo	Ø 38 mm
Capacità di foratura su acciaio con preforo	Ø 32 mm
Capacità di foratura continua	Ø 28 mm
Cono morse	4
Mandrino	1 ÷ 13 mm B16
Velocità del mandrino	100 - 2200 rpm
Corsa mandrino	130 mm
Canotto	75 mm
Colonna	123 mm
Divisione avanzamento verticale manuale	0,05 mm
Distanza asse mandrino - colonna	300 mm
Distanza tra naso macchina e tavola	50 ÷ 800 mm
Distanza tra naso macchina e base	1220 mm
Dimensione tavola	500 x 380 mm
Cava	14 mm
Inclinazione tavola	±90°
Morsa	125 mm
Dimensioni base	610 x 670 mm
Motore	400 V 50 Hz 1,1 - 1,9 kW
Pompa di refrigerazione	400 V 50 Hz 90 W
Dimensioni	700 x 1100 x 1900 mm
Peso netto	375 kg

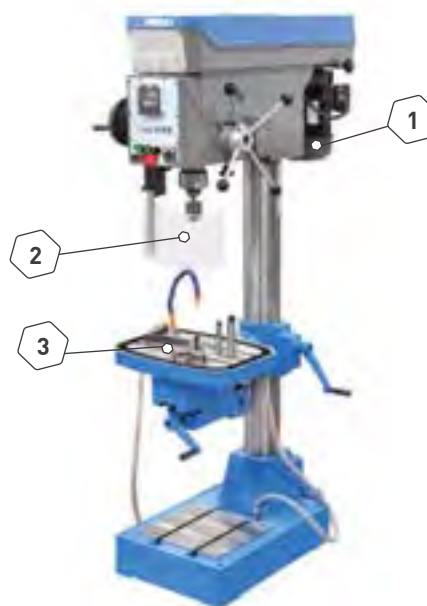
**T032DA**

€ 3850,00

TRAPANO A COLONNA CON TRASMISSIONE A CINGHIA

Con discesa automatica, sistema di refrigerazione, tavola parzialmente girevole, con morsa da 125mm.

- 1 **Motore ad induzione** 3 **Morsa inclusa**
 2 **Protezione mandrino** 4 **Leva sollevamento tavola**

ACCESSORI INCLUSI

- Mandrino a cremagliera 1 ÷ 16 B18
- Attacco mandrino CM 3
- Bussola di riduzione CM 3/2

Capacità di foratura su ghisa con preforo	Ø 31,75 mm
Capacità max di foratura su acciaio con preforo (s235jr)	Ø 31,75 mm
Capacità di foratura continua	Ø 25 mm
Cono morse	CM 3
Mandrino	1 ÷ 16 B18
Velocità del mandrino	(8) 160 ÷ 2200 rpm
Corsa mandrino	130 mm
Colonna	Ø 115 mm
Velocità di discesa	0,1 - 0,16 - 0,26 mm/giro
Distanza asse mandrino - colonna	223 mm
Distanza tra naso macchina e tavola	696 mm
Distanza tra naso macchina e base	1135 mm
Dimensioni tavola	400 x 470 mm
Corsa tavola	510 mm
Cava	14 mm
Dimensioni base	400 x 310 mm
Motore	400 V 50 Hz 0,85 kW / 1,1 kW
Pompa di refrigerazione	400 V 50 Hz 40 W
Dimensioni	900 x 545 x 1765 mm
Peso netto	350 kg



T032

€ 3050,00

TRAPANO A COLONNA CON TRASMISSIONE A CINGHIA

Tavola parzialmente girevole, con morsa da 125mm

- 1 **Motore ad induzione**
- 2 **Protezione mandrino**
- 3 **Morsa inclusa**
- 4 **Leva sollevamento tavola**

ACCESSORI INCLUSI

- Mandrino a cremagliera 1 ÷ 16 B18
- Attacco mandrino CM 3
- Bussola di riduzione CM 3/2

Capacità di foratura su ghisa con preforo	Ø 31,75 mm
Capacità max di foratura su acciaio con preforo (s235jr)	Ø 31,75 mm
Cono morse	CM 3
Capacità di foratura continua	Ø 25 mm
Mandrino	1 ÷ 16 B18
Velocità del mandrino	(9) 160 ÷ 1880 rpm
Corsa mandrino	130 mm
Colonna	Ø 102 mm
Distanza asse mandrino - colonna	230 mm
Distanza tra naso macchina e tavola	700 mm
Distanza tra naso macchina e base	1175 mm
Dimensioni tavola	330 x 380 mm
Corsa tavola	670 mm
Cava	14 mm
Dimensioni base	300 x 325 mm
Motore	400V 50Hz 1,5 kW
Dimensioni	900 x 430 x 1760 mm
Peso netto	340 kg

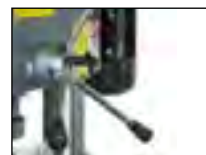
T071

€ 3170,00

TRAPANO A COLONNA CON TRASMISSIONE A CINGHIA

Inversione di marcia, funzione di maschiatura, tavola reversibile con morsa da 120mm.

- 1 **Motore ad induzione**
- 2 **Protezione mandrino**
- 3 **Tavola ribaltabile con morsa**
- 4 **Leva sollevamento tavola**

ACCESSORI INCLUSI

- Mandrino a cremagliera 1 ÷ 13 mm B16
- Attacco mandrino CM 3 B16
- Bussola di riduzione CM 3/2
- Bussola di riduzione CM 2/1

Capacità di foratura su ghisa con preforo	Ø 30 mm
Capacità max di foratura su acciaio con preforo (s235jr)	Ø 28 mm
Capacità di foratura continua	Ø 25 mm
Cono morse	CM 3
Mandrino	1 ÷ 13 mm B16
Velocità del mandrino	(16) 127 ÷ 2380 rpm
Corsa mandrino	100 mm
Canotto	Ø 62 mm
Colonna	Ø 98 mm
Distanza asse mandrino - colonna	203 mm
Distanza tra naso macchina e tavola	145-895 mm
Distanza tra naso macchina e base	1200 mm
Dimensione tavola	350 x 280 mm
Cava	12 mm
Inclinazione tavola	±90°
Morsa	90 mm
Dimensioni base	410 x 560 mm
Motore	400 V 50 Hz 0,5 / 1 kW
Dimensioni	530 x 820 x 1700 mm
Peso netto	200 kg



0252/230V & 0252/400V

€ 1880,00

TRAPANO A COLONNA CON TRASMISSIONE A CINGHIA

Misuratore digitale di profondità, tavola reversibile con morsa integrata scorrevole, nuovo tendicinghia, luce a Led integrata.

- 1 **Illuminazione**
- 2 **Leva sollevamento tavola**
- 3 **Testa in fusione**
- 4 **Tavola inclinabile con morsa integrata**

ACCESSORI INCLUSI

- Mandrino autoserrante 1 - 16 mm / B16
- Attacco mandrino CM 4

Capacità di foratura su ghisa con preforo	Ø 32 mm
Capacità max di foratura su acciaio con preforo (s235jr)	Ø 28 mm
Capacità di foratura continua	Ø 20 mm
Cono morse	4
Mandrino	1 - 16 mm B16
Velocità del mandrino	(12) 150 ÷ 2450 rpm
Corsa mandrino	120 mm
Canotto	Ø 62 mm
Colonna	Ø 92 mm
Altezza	1720 mm
Distanza asse mandrino - colonna	255 mm
Distanza naso macchina-tavola	700 mm
Dimensioni tavola	470 x 420 mm
Distanza naso macchina-base	1220 mm
Cava	14 mm
Morsa	120 x 155 mm
Motore	230 V 50 Hz 1,5 kW 400 V 50 Hz 1,5 kW
Peso netto	135 kg

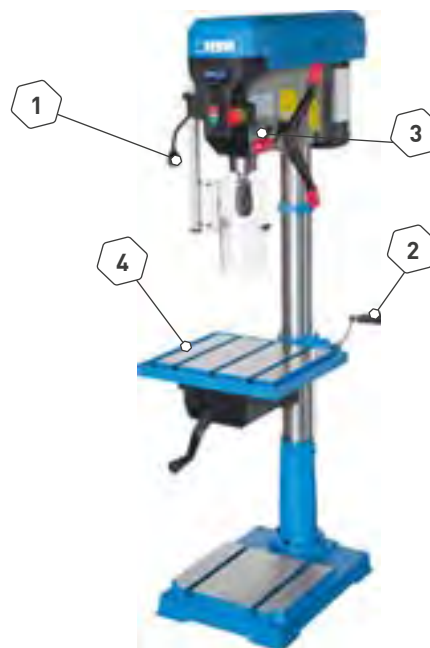

0754/230V & 0754/400V

€ 1620,00

TRAPANO A COLONNA CON TRASMISSIONE A CINGHIA

Tavola inclinabile

- 1 **Motore ad induzione**
- 2 **Leva sollevamento tavola**
- 3 **Testa in fusione**
- 4 **Tavola inclinabile**

ACCESSORI INCLUSI

- Mandrino autoserrante 5 - 20 mm B22
- Attacco mandrino CM 4

Capacità di foratura su ghisa con preforo	Ø 32 mm
Capacità max di foratura su acciaio con preforo (s235jr)	Ø 28 mm
Capacità di foratura continua	Ø 20 mm
Cono morse	CM 4
Mandrino	5 - 20 mm B22
Velocità del mandrino	(12) 150 ÷ 2450 rpm
Corsa mandrino	120 mm
Canotto	Ø 62 mm
Colonna	Ø 92 mm
Altezza	1710 mm
Distanza asse mandrino - colonna	260 mm
Dimensioni tavola	475 x 425 mm
Cava	14 mm
Inclinazione tavola	± 45°
Motore	230 V 50 Hz 1,5 kW 400 V 50 Hz 1,5 kW
Peso netto	125 kg



0752CM3

€ 1010,00

TRAPANO A COLONNA CON TRASMISSIONE A CINGHIA

Tavola girevole ed inclinabile. Impianto elettrico con circuito separato a 24V per i comandi bordo macchina.

0752

€ 947,00

CM2 Ø 16 mm

ACCESSORI INCLUSI

- Mandrino autoserrante 1 - 16 mm B18
- Brugole
- Attacco mandrino CM 3
- Cavaconi

Capacità di foratura su ghisa con preforo	Ø 25 mm
Capacità max di foratura su acciaio con preforo (s235jr)	Ø 20 mm
Capacità di foratura continua	Ø 16 mm
Cono morse	CM 3
Mandrino	1 - 16 mm / B16
Velocità del mandrino	(16) 220 ÷ 2840 rpm
Corsa mandrino	80 mm
Canotto	Ø 47 mm
Colonna	Ø 80 mm
Altezza	1630 mm
Distanza asse mandrino - colonna	175 mm
Distanza naso macchina-tavola	420 mm
Distanza tra naso macchina e base	1190 mm
Dimensioni tavola	290 x 290 mm
Cava	16 mm
Inclinazione tavola	± 45°
Tavola girevole	SI
Dimensioni base	460 x 275 mm
Motore	230 V 50 Hz 0,75 kW
Dimensioni	300 X 630 X 1630h mm
Peso netto	62 kg

0186

€ 840,00

TRAPANO A COLONNA CON TRASMISSIONE A CINGHIA

Tavola girevole e inclinabile. Impianto elettrico con circuito separato a 24V per i comandi bordo macchina.

ACCESSORI INCLUSI

- Mandrino autoserrante 1 - 16 mm B16
- Attacco mandrino CM 2

Capacità di foratura su ghisa con preforo	Ø 20 mm
Capacità max di foratura su acciaio con preforo (s235jr)	Ø 16 mm
Capacità di foratura continua	Ø 12 mm
Cono morse	CM 2
Mandrino	1 - 16 mm B16
Velocità del mandrino	(12) 280 ÷ 2380 rpm
Corsa mandrino	80 mm
Canotto	Ø 40 mm
Colonna	Ø 72 mm
Altezza	1580 mm
Distanza asse mandrino - colonna	160 mm
Distanza tra naso macchina e base	1110 mm
Dimensioni tavola	Ø 290 mm
Inclinazione tavola	± 45°
Motore	230 V 50 Hz 0,65 kW
Peso netto	50 kg





TRAPANI DA BANCO



CM

Corsa mandrino (mm)

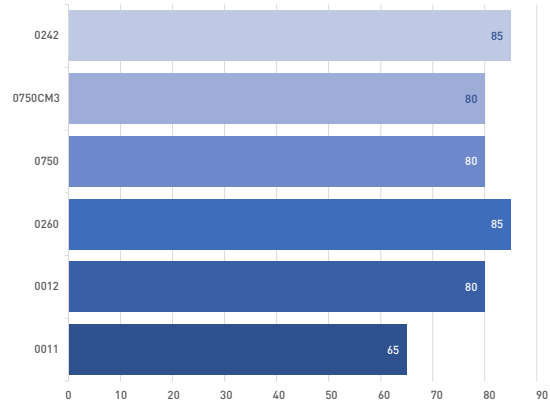
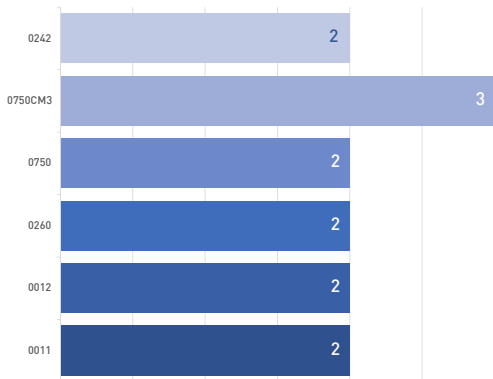

Diametro colonna (mm)

Dimensioni tavola (mm)

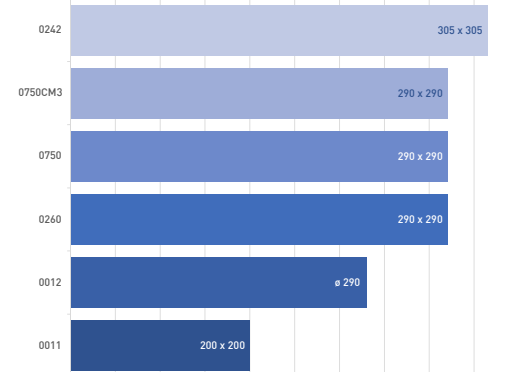
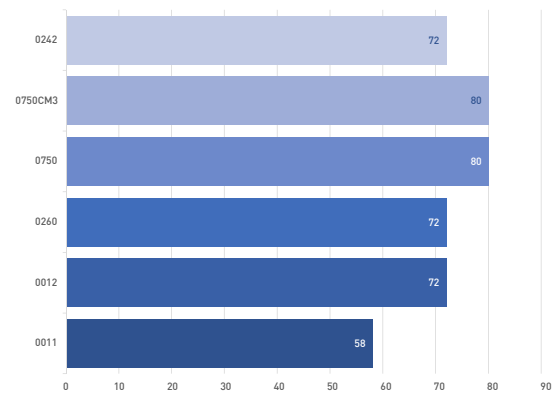

0242

€ 904,00

TRAPANO DA BANCO CON TRASMISSIONE A CINGHIA

Misuratore digitale di profondità, nuovo tendicinghia, luce a Led integrata, tavola girevole ed inclinabile. Impianto elettrico con circuito separato a 24V per i comandi bordo macchina.

- 1 **Motore ad induzione**
- 2 **Leva sollevamento tavola**
- 3 **Illuminazione**
- 4 **Tavola inclinabile**

ACCESSORI INCLUSI

- Mandrino autoserrante 1 - 16 mm B18
- Attacco mandrino CM 2

Capacità di foratura su ghisa con preforo	Ø 25 mm
Capacità max di foratura su acciaio con preforo [s235jr]	Ø 20 mm
Capacità di foratura continua	Ø 16 mm
Cono morse	CM 2
Mandrino	1 - 16 mm B18
Velocità del mandrino	(16) 180 ÷ 2770 rpm
Corsa mandrino	85 mm
Canotto	Ø 47 mm
Colonna	Ø 72 mm
Altezza	990 mm
Distanza asse mandrino - colonna	180 mm
Distanza naso macchina-tavola	420 mm
Distanza naso macchina-base	600 mm
Dimensioni tavola	305 x 305 mm
Cava	16 mm
Inclinazione tavola	± 45°
Motore	230 V 50 Hz 0,75 kW
Peso netto	60 kg



0750CM3

€ 898,00

TRAPANO DA BANCO CON TRASMISSIONE A CINGHIA

Tavola girevole ed inclinabile. Impianto elettrico con circuito separato a 24V per i comandi bordo macchina.

- 1 **Motore ad induzione**
- 2 **Leva sollevamento tavola**
- 3 **Tavola inclinabile**

0750 € 847,00
CM2 Ø 16 mm

ACCESSORI INCLUSI

- Mandrino autoserrante 1 - 16 mm B16
- Attacco mandrino CM 2
- Cavaconi
- Brugole

Capacità di foratura su ghisa con preforo	Ø 25 mm
Capacità max di foratura su acciaio con preforo [s235jr]	Ø 20 mm
Capacità di foratura continua	Ø 16 mm
Cono morse	CM 3
Mandrino	1 - 16 mm B16
Velocità del mandrino	(16) 220 ÷ 2840 rpm
Corsa mandrino	80 mm
Canotto	Ø 47 mm
Colonna	Ø 80 mm
Altezza	980 mm
Dimensioni tavola	290 x 290 mm
Distanza asse mandrino - colonna	175 mm
Distanza tra naso macchina e tavola	420 mm
Distanza tra naso macchina e base	600 mm
Cava	14 mm
Inclinazione tavola	± 45°
Tavola girevole	Si
Dimensioni base	460 x 275 mm
Motore	230 V 50 Hz 0,75 kW
Dimensioni	300 x 630 x 990h mm
Peso netto	57 kg



0260

€ 797,00

TRAPANO DA BANCO CON TRASMISSIONE A CINGHIA

Misuratore digitale di profondità, nuovo tendicinghia, luce a Led integrata, tavola girevole ed inclinabile. Impianto elettrico con circuito separato a 24V per i comandi bordo macchina.

- 1 **Motore ad induzione**
- 2 **Leva sollevamento tavola**
- 3 **Illuminazione**
- 4 **Tavola inclinabile e girevole**

ACCESSORI INCLUSI

- Mandrino autoserrante 1 - 16 mm B16
- Attacco mandrino CM 2

Capacità di foratura su ghisa con preforo	Ø 20 mm
Capacità max di foratura su acciaio con preforo (s235jr)	Ø 16 mm
Capacità di foratura continua	Ø 12 mm
Cono morse	CM 2
Mandrino	1 - 16 mm B16
Velocità del mandrino	(16) 180 ÷ 2770 rpm
Corsa mandrino	85 mm
Canotto	Ø 40 mm
Colonna	Ø 72 mm
Altezza	980 mm
Distanza asse mandrino - colonna	160 mm
Distanza naso macchina-tavola	435 mm
Distanza naso macchina-base	625 mm
Dimensioni tavola	290 x 290 mm
Cava	16 mm
Inclinazione tavola	± 45°
Motore	230 V 50 Hz 0,55 kW
Peso netto	50 kg



0012

€ 622,00

TRAPANO DA BANCO CON TRASMISSIONE A CINGHIA

Tavola girevole e inclinabile. Impianto elettrico con circuito separato a 24V per i comandi bordo macchina.

- 1 **Motore ad induzione**
- 2 **Leva sollevamento tavola**
- 3 **Testa in fusione**
- 4 **Tavola inclinabile e girevole**

ACCESSORI INCLUSI

- Mandrino Autoserrante 1 - 16 mm B16
- Attacco mandrino CM 2

Capacità di foratura su ghisa con preforo	Ø 20 mm
Capacità max di foratura su acciaio con preforo (s235jr)	Ø 16 mm
Capacità di foratura continua	Ø 12 mm
Mandrino	1 - 16 mm B16
Velocità del mandrino	(12) 280 ÷ 2380 rpm
Corsa mandrino	80 mm
Canotto	Ø 40 mm
Colonna	Ø 72 mm
Altezza	990 mm
Distanza asse mandrino - colonna	160 mm
Distanza tra naso macchina e tavola	435 mm
Distanza tra naso macchina e base	650 mm
Dimensioni tavola	Ø 290 mm
Motore	230 V 50 Hz 0,65 kW
Peso netto	48 kg



0011

€ 460,00

TRAPANO DA BANCO CON TRASMISSIONE A CINGHIA

Spostamento verticale a cremagliera della tavola, tavola inclinabile. Impianto elettrico con circuito separato a 24V per i comandi bordo macchina.

**ACCESSORI INCLUSI**

- Mandrino autoserrante 1 - 13 mm B16

Capacità di foratura su ghisa con preforo	Ø 13 mm
Capacità max di foratura su acciaio con preforo (s235jr)	Ø 10 mm
Mandrino	1 - 13 mm B16
Velocità del mandrino	(5) 620 ÷ 2620 rpm
Corsa mandrino	65 mm
Canotto	Ø 40 mm
Colonna	Ø 58 mm
Altezza	690 mm
Distanza asse mandrino - colonna	130 mm
Distanza tra naso macchina e base	330 mm
Dimensione tavola	190 x 200 mm
Inclinazione tavola	± 45°
Motore	230 V 50 Hz 0,375 kW
Dimensioni	315 x 530 x 690h mm
Peso netto	25 kg



0518/20

€ 814,00

TRAPANO MAGNETICO

Con raffreddamento a liquido per frese a carotare fino a Ø 20mm con attacco weldon Ø 19.05mm e punte cilindriche fino a Ø 20mm con codolo ridotto a Ø 13mm.



Capacità di foratura continua	Ø 20 mm
Mandrino a cremagliera	Ø 13 mm
Albero	Weldon Ø 19,05 mm
Corsa mandrino	165 mm
Capacità max. di lavoro	Ø 20 mm
Forza magnetica max.	8500 N
Velocità del mandrino	650 rpm
Motore	230 V 50 Hz 0.9 kW
Dimensioni	300 x 260 x 450 mm
Valigetta	442 x 395 x 175 mm
Peso netto	15 kg

0518/30

€ 1110,00

TRAPANO MAGNETICO

Con raffreddamento a liquido per frese a carotare fino a Ø 30mm con attacco weldon Ø 19.05mm e punte cilindriche fino a Ø 20mm con codolo ridotto a Ø 13 - 16mm.

Capacità di foratura continua	Ø 20 mm
Mandrino a cremagliera	Ø 16 mm
Albero	Weldon Ø 19,05 mm
Corsa mandrino	175 mm
Capacità max. di lavoro	Ø 30 mm
Forza magnetica max.	11000 N
Velocità del mandrino	450 rpm
Dimensioni base	170 x 90 mm
Motore	230 V 50 Hz 1.1 kW
Dimensioni	360 x 280 x 490 mm
Valigetta	527 x 472 x 242 mm
Peso netto	23 kg

0518/50

€ 1520,00

TRAPANO MAGNETICO

Con raffreddamento a liquido per frese a carotare fino a Ø 50mm con attacco weldon Ø 19.05mm, punte con attacco conico cm 3 e punte cilindriche fino a Ø 20mm con codolo ridotto a Ø 13 - 16mm.

Capacità di foratura continua	Ø 20 mm
Mandrino a cremagliera	Ø 16 mm
Cono albero CM	3
Albero	Weldon Ø 19,05 mm
Corsa mandrino	220 mm
Capacità max. di lavoro	Ø 50 mm
Forza magnetica max.	15000 N
Velocità del mandrino	400 - 600 rpm
Dimensioni base	205 x 110 mm
Motore	230 V 50 Hz 1.5 kW
Dimensioni	400 x 310 x 475 mm
Valigetta	587 x 489 x 265 mm
Peso netto	35 kg



0518/38M

€ 1250,00

TRAPANO/MASCHIATORE MAGNETICO

Con raffreddamento a liquido per frese a carotare fino a Ø 38mm con attacco weldon Ø 19.05mm e punte cilindriche fino a Ø 20mm con codolo ridotto a Ø 13 - 16mm, capacità di maschiatura M4 - M16.



Capacità di foratura continua	Ø 20 mm
Cono albero CM	2
Albero	Weldon Ø 19,05 mm
Corsa mandrino	180 mm
Capacità max. di lavoro	Ø 38 mm
Capacità di maschiatura	M4 ÷ M16
Forza magnetica max.	12000 N
Velocità del mandrino	0 ÷ 500 l 0 ÷ 800 rpm
Motore	230 V 50 Hz 1.05 kW
Dimensioni base	205 x 105 mm
Dimensioni	280 x 320 x 510h mm
Peso netto	20 kg

**0518/55H**

€ 1570,00

TRAPANO MAGNETICO ORIZZONTALE

Per frese a carotare fino a Ø 55 mm con attacco weldon Ø 19.05 mm



Albero	Weldon Ø 19,05 mm
Corsa mandrino	55 mm
Capacità max. di lavoro	Ø 55 mm
Forza magnetica max.	15500 N
Velocità del mandrino	640 rpm
Motore	230 V 50 Hz 1,9 kW
Dimensioni base	165 x 80 mm
Dimensioni	290 x 170 x 185 h mm
Valigetta	400 x 335 x 165 mm
Peso netto	8.5 kg

**0518/80**

€ 1960,00

TRAPANO MAGNETICO

Con raffreddamento a liquido per frese a carotare fino a Ø 80 mm con attacco weldon Ø 19.05 mm, punte con attacco conico cm 3 e punte cilindriche fino a Ø 20 mm con codolo ridotto a Ø 13 - 16 mm



Capacità di foratura continua	Ø 20 mm
Cono albero CM	3
Albero	Weldon Ø 19,05 mm
Corsa mandrino	280 mm
Forza magnetica max.	20000 N
Velocità del mandrino	230 ÷ 770 rpm
Motore	230 V 50 Hz 1.8 kW
Dimensioni base	215 x 110 mm
Dimensioni	290 x 410 x 550h mm
Peso netto	35 kg



SEGATRICI A NASTRO



Potenza (kW)

Peso netto (Kg)

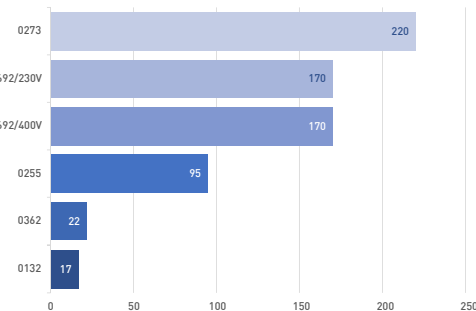
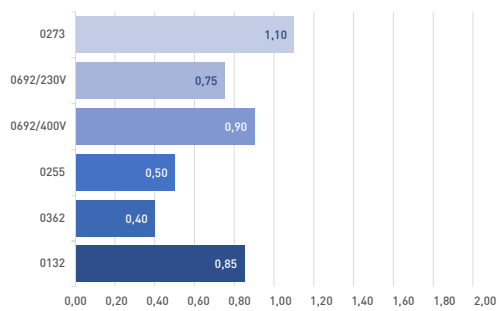

Angolo di taglio

Capacità di taglio 90°

Capacità di taglio 45°

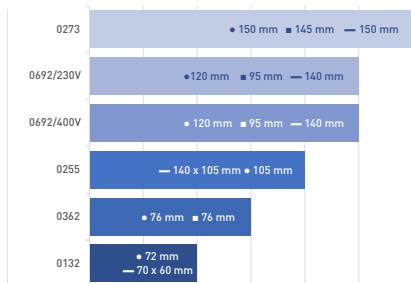
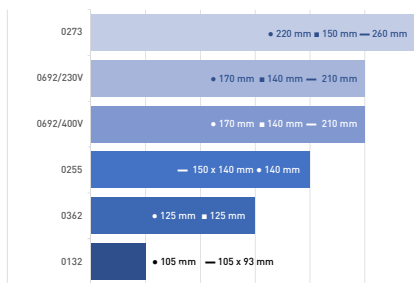
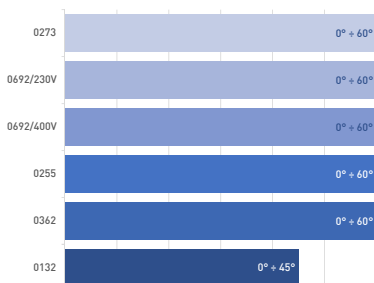

0273

€ 3920,00

SEGATRICE A NASTRO CON DISCESA MANUALE E IDRAULICA

Con strumento di regolazione tensione lama, sistema di refrigerazione, morsa rapida

ACCESSORI INCLUSI

- Strumento di regolazione tensione lama
- Pompa refrigerante
- Morsa rapida

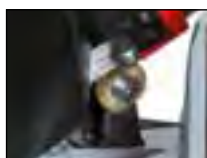

Dimensioni lama	2450 x 27 x 0,9 mm
Motore trifase	400V 50 HZ 0,59 / 1,1 kW
Velocità di taglio	36 - 72 m/min
Angolo di taglio	0° ÷ 60°
Capacità di taglio a 90°	• 220 mm ■ 150 mm — 260 mm
Capacità di taglio a 45°	• 150 mm ■ 145 mm — 150 mm
Ganasce	150 x 120 h mm
Apertura morsa	260 mm
Dimensioni	1720 x 880 x 1810 h mm
Peso netto	220 kg

**0692/230V & 0692/400V**

€ 3100,00

SEGATRICE A NASTRO CON DISCESA MANUALE E IDRAULICA

Con strumento di regolazione tensione lama, sistema di refrigerazione, morsa rapida

ACCESSORI INCLUSI

- Strumento di regolazione tensione lama
- Pompa refrigerante
- Morsa rapida



Dimensioni lama	2100 x 20 x 0,9 mm
Motore	230V 50 Hz 0,75 kW 400V 50 HZ 0,55 / 0,9 kW
Velocità di taglio	65 m/min
Angolo di taglio	0° ÷ 60°
Capacità di taglio a 90°	• 170 mm ■ 140 mm — 210 mm
Capacità di taglio a 45°	• 120 mm ■ 95 mm — 140 mm
Apertura morsa	260 mm
Dimensioni	1500 x 800 x 1620 h mm
Peso netto	170 kg



0255

€ 1630,00

SEGATRICE A NASTRO PER METALLI

Con sistema di refrigerazione, morsa rapida, basamento con vano portautensili



Dimensioni lama	1735 x 13 x 0,65 mm
Motore	230 V 50 Hz 0,5 kW
Angolo di taglio	0 ÷ 60°
Velocità di taglio	34 m / min
Capacità di taglio a 90°	— 150 x 140 mm • 140 mm
Capacità di taglio a 45°	— 140 x 105 mm • 105 mm
Dimensioni base	470 x 700 mm
Dimensioni	530 x 1000 x 1260h mm
Peso netto	95 kg

0362

€ 787,00

SEGATRICE A NASTRO ELETTRONICA DA BANCO

Con motore inverter



Dimensioni lama	1435 x 12,7 x 0,65 mm
Motore	230 V 50 Hz 0,4 kW
Velocità di taglio	35 m / min
Angolo di taglio	0° ÷ 60°
Capacità di taglio a 90°	• 125 mm ■ 125 mm
Capacità di taglio a 45°	• 76 mm ■ 76 mm
Dimensioni	700 x 360 x 450h mm
Peso netto	22 kg





0132

€ 496,00

SEGATRICE A NASTRO

Da banco, trasportabile, a due velocità di taglio



Dimensioni lama	1335 x 12,7 x 0,65 mm
Velocità	(2) 60 80 m / min
Angolo di taglio	0° ÷ 45°
Motore	230 V 50 Hz 0,850 kW
Capacità di taglio a 90°	• 105 mm — 105 x 93 mm
Capacità di taglio a 45°	• 72 mm — 70 x 60 mm
Peso netto	17 kg



0522

€ 261,00

SUPPORTO PIEGHEVOLE PER MACCHINE PORTATILI

Telaio robusto e resistente, altezza regolabile.



Portata	150 kg
Dimensioni piano	820 x 460 mm
Altezza tavola	600 - 715 - 745 - 770 - 795 - 820 mm
Distanza rulli	870 - 1070 - 1350 mm
Altezza rulli	37 ÷ 470 mm
Peso netto	17 kg

0133

€ 147,00

CAVALLETTO A RULLO



Diametro albero del rullo	Ø 52 x 350 mm
Altezza	690 / 1200 mm
Portata max	50 ÷ 60 kg
Peso netto	15 kg

R003/09

NEW € 463,00

RULLIERA A PANTOGRAFO



Portata	130 kg
Diametro dei rulli	50 mm
Lunghezza	485 ÷ 1400 mm
Altezza	610 ÷ 950 mm
Ingombro	1460 x 660 x 950 h mm
Peso netto	31 kg

R001-
RULLIERA REGOLABILE IN ALTEZZA

Con piedini a regolazione indipendente dell'altezza

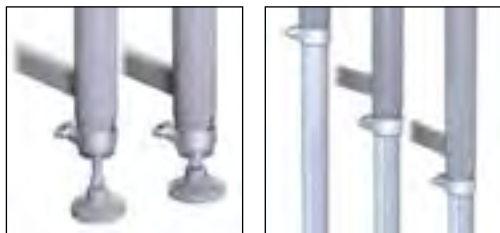

Art.	€	Dimensioni	Distanza rulli	Dimensioni rulli	Altezza	Portata max	Peso netto
R001/04	€ 348,00	1000 x 460 mm	260 mm	Ø 60 x 360 mm M12	580 / 1030 mm	400 kg	23 kg
R001/07	€ 489,00	2000 x 450 mm	250 mm	Ø 60 x 360 mm M12	590 / 1050 mm	400 kg	37 kg

0642
€ 342,00
TRONCATRICE VELOCE

Per il taglio a secco di metalli, con carter di protezione disco.



Motore	230 V 50 Hz 2 kW
Dimensioni disco	355 x 3.0 x 25.4 mm
Velocità disco	3800 rpm
Angolo di taglio	± 45°
Capacità di taglio	■ 100 x 100 mm - ■ 200 x 40 mm - o 100 mm
Apertura morsa	155 mm - 190 mm - 230 mm
Peso netto	19 kg

0565
€ 172,00
SMERIGLIATRICE AD ALBERO FLESSIBILE

Con variatore di velocità a pedale



Mandrino di precisione con chiave	0 - 4 mm
Velocità variabile	500 ÷ 22000 rpm
Lunghezza albero flessibile	900 mm
Motore	230 V 50 Hz 185 W

0568
€ 57,80
MINI SMERIGLIATRICE CON UTENSILI

Supporto da banco ed albero flessibile



Mandrino di precisione con chiave	Ø 3 mm
Velocità variabile	8000 ÷ 32500 rpm
Lunghezza albero flessibile	1000 mm
Altezza supporto	650 mm
Capacità morsetto	65 mm
Motore	230 V 50 Hz 135 W



SMERIGLIATRICI

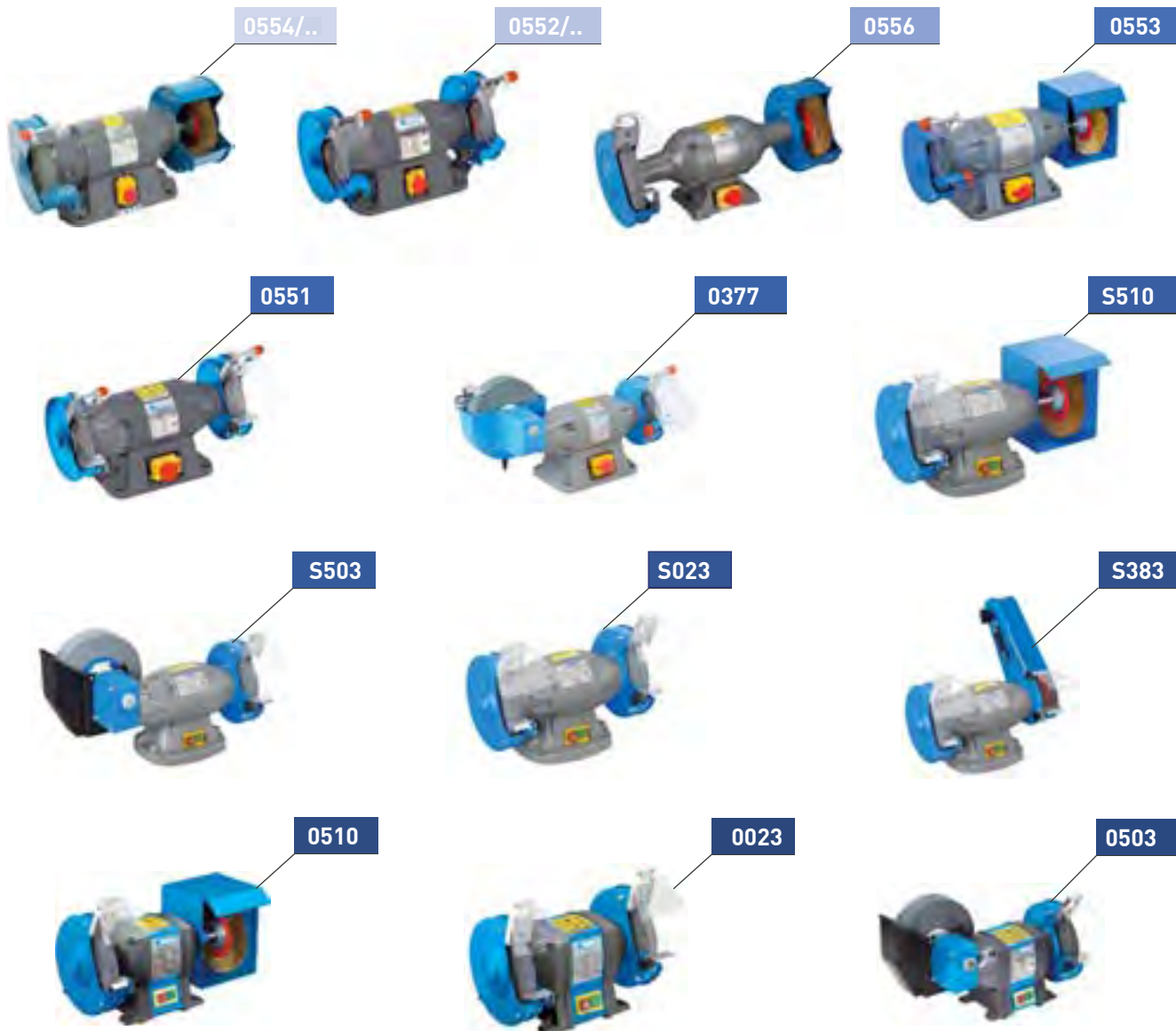

Potenza (kW)

Peso (Kg)

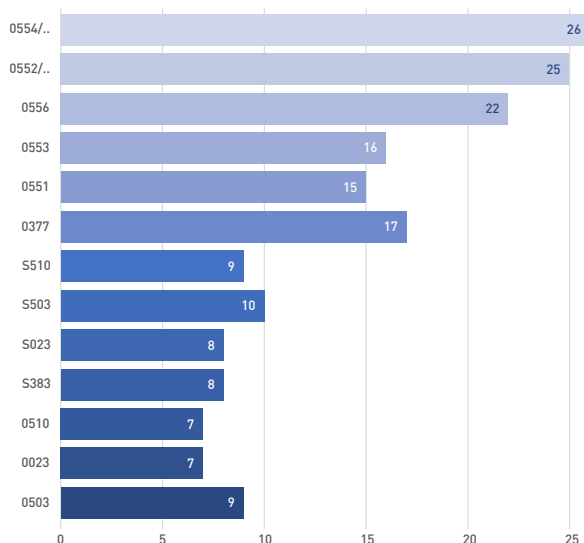
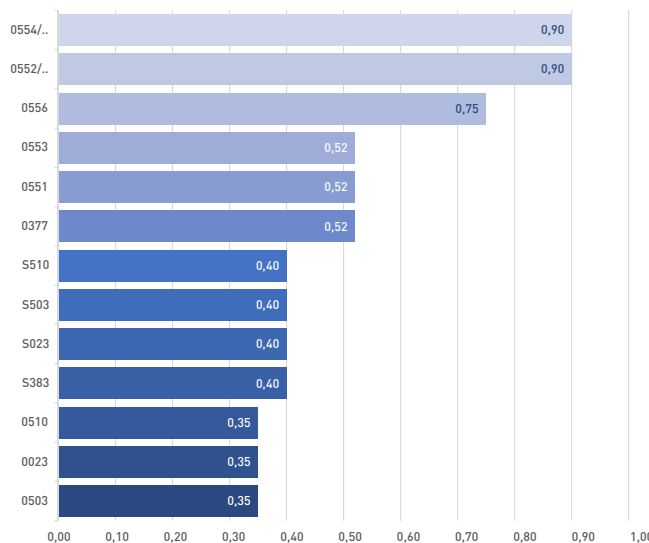

0554 & 0554/400V
€ 348,00
SMERIGLIATRICE COMBINATA PROFESSIONALE

Spazzola	2950 rpm - Ø 200 x 25 x 20 mm
Mola a secco	2950 rpm - Ø 200 x 25 x 20 mm GR36
Motore	230V 50 Hz 0,9 kW 400V 50 Hz 0,9 kW
Tipo di utilizzo	S2 - 10 min
Peso netto	26 kg

0552 & 0552/400V
€ 320,00
SMERIGLIATRICE DA BANCO PROFESSIONALE

Mola a secco	2950 rpm - Ø 200 x 25 x 20 mm GR36 - GR80
Motore	230V 50Hz 0,9 kW 400V 50 Hz 0,9 kW
Tipo di utilizzo	S2 - 10 min
Peso netto	25 kg

0556
€ 252,00
SMERIGLIATRICE COMBINATA PROFESSIONALE CON ALBERI LUNGI

Smerigliatrice combinata professionale con alberi lunghi



Spazzola	2950 rpm - Ø 200 x 25 x 20 mm
Mola a secco	2950 rpm - Ø 200 x 25 x 20 mm GR36
Motore	230 V 50 Hz 0,75 kW
Tipo di utilizzo	S2 - 10 min
Interasse mole	510 mm
Peso netto	22 kg

0553
€ 218,00
SMERIGLIATRICE COMBINATA PROFESSIONALE

Robusta e affidabile, dispositivi di protezione mole, squadretta appoggio pezzi.



Spazzola	2950 rpm - Ø 150 x 20 x 16 mm
Mola a secco	2950 rpm - Ø 150 x 20 x 16 mm GR36
Motore	230 V 50 Hz 0,52 kW
Tipo di utilizzo	S2 - 10 min
Dimensioni	440 x 170 x 225 mm
Peso netto	16 kg

0551
€ 203,00
SMERIGLIATRICE DA BANCO PROFESSIONALE

Mola a secco	2950 rpm - Ø 150 x 20 x 16 mm GR36 - GR80
Motore	230 V 50 Hz 0,52 kW
Tipo di utilizzo	S2 - 10 min
Dimensioni	440 x 170 x 225 mm
Peso netto	15 kg

0377
€ 252,00
SMERIGLIATRICE COMBINATA

Mola a secco	2950 rpm - Ø 150 x 20 x 16 mm GR80
Mola ad acqua	130 rpm - Ø 200 x 40 x 20 mm GR80
Motore	230 V 50 Hz 0,52 kW
Tipo di utilizzo	S2 - 10 min
Peso netto	17 kg

S510 € 152,00

SMERIGLIATRICE COMBINATA DA BANCO

Con mola e spazzola



Spazzola	2950 rpm - Ø 150 x 20 x 16 mm
Mola a secco	2950 rpm - Ø 150 x 20 x 16 mm GR36
Motore	230 V 50 Hz 0,40 kW
Tipo di utilizzo	S2 - 10 min
Peso netto	9 kg

S503 € 157,00

SMERIGLIATRICE COMBINATA DA BANCO

Con mola ad acqua e mola a secco



Mola a secco	2950 rpm - Ø 150 x 20 x 16 mm GR80
Mola ad acqua	130 rpm - Ø 200 x 40 x 20 mm GR80
Motore	230 V 50 Hz 0,40 kW
Tipo di utilizzo	S2 - 10 min
Peso netto	10 kg

S023 € 137,00

SMERIGLIATRICE DA BANCO

Con due mole di grana differenziata



Mola a secco	2950 rpm - Ø 150 x 20 x 16 mm GR36 - GR80
Motore	2950 rpm - 230 V 50 Hz 0,40 kW
Tipo di utilizzo	S2 - 10 min
Peso netto	8 kg

S383 € 173,00

SMERIGLIATRICE DA BANCO CON LEVIGATRICE



Mola a secco	2950 rpm Ø 150 x 20 x 16 mm GR36
Nastro	50 x 686 mm GR100
Motore	230 V 50 Hz 0,40 kW
Tipo di utilizzo	S2 - 10 min
Peso netto	8 kg

0510 € 111,00

SMERIGLIATRICE COMBINATA DA BANCO

Con mola e spazzola. Squadretta per appoggio pezzi. Fori per il fissaggio sul banco.



Spazzola	2950 rpm - Ø 150 x 20 x 12,7 mm
Mola a secco	2950 rpm - Ø 150 x 20 x 12,7 mm GR36
Motore	230 V 50 Hz 0,35 kW
Tipo di utilizzo	S2 - 10 min
Peso netto	7 kg

0023 € 100,00

SMERIGLIATRICE DA BANCO

Schermi di protezione mole. Squadretta per appoggio pezzo



Mola a secco	2950 rpm - Ø 150 x 20 x 12,7 mm GR36 - GR80
Motore	2950 rpm - 230 V 50 Hz 0,35 kW
Tipo di utilizzo	S2 - 10 min
Peso netto	7 kg



0503

€ 114,00

SMERIGLIATRICE COMBINATA DA BANCO

Con mola ad acqua e mola a secco



Mola a secco	2950 rpm - Ø 150 x 20 x 12,7 mm GR80
Mola ad acqua	130 rpm - Ø 200 x 40 x 20 mm GR80
Motore	230 V 50 Hz 0,35 kW
Tipo di utilizzo	S2 - 10 min
Peso netto	9 kg

0555

€ 127,00

SUPPORTO PER SMERIGLIATRICI



Altezza	760 mm
Colonna	Ø 75 mm
Dimensioni tavola	320 x 210 mm
Peso netto	13.5 kg

0106

€ 97,80

SUPPORTO PER SMERIGLIATRICI

Di tipo leggero



Altezza	760 mm
Colonna	Ø 75 mm
Dimensioni tavola	320 x 210 mm
Peso netto	11 kg

0316

€ 180,00

AFFILCATENE PER MOTOSEGA



Mola rosa	Ø 145 x 4,7 x 22,3 mm Ø 145 x 3,2 x 22,3 mm
Affilatura	+30° / -35°
Per catene	1/4" - 3/8" - 3/8" - 404" - 3/4"
Motore	230 V 50 Hz 0,23 kW
Peso netto	5 kg

0502

€ 84,40

AFFILCATENE PER MOTOSEGA

Con leva avanzamento catena. Schermo di protezione mola



Mola rosa	Ø 100 x 4,5 x 10 mm
Affilatura	+35° / -35°
Per catene	1/4" - 0,325" / 3/8" - 0,404"
Motore	230 V 50 Hz 0,25 kW
Velocità	7500 rpm
Tipo di utilizzo	intermittente S2

A003/32

€ 2940,00

AFFILATRICE PER PUNTE ELICOIDALI

Con pinze ER per le punte e dispositivo inclinazione dei taglienti, assottigliamento del nocciolo per una maggiore precisione. Possibilità di affilare punte in metallo duro con mola opzionale.



Capacità di affilatura	3 ÷ 32 mm
Inclinazione punta	95° ÷ 135° / 85° ÷ 140°
Velocità	4400 rpm
Motore	230 V 50 Hz 250 W
Dimensioni	400 x 260 x 300 mm
Peso netto	36 kg

A003/13A

€ 815,00

AFFILATRICE PER PUNTE ELICOIDALI

Con pinze ER per le punte e dispositivo inclinazione dei taglienti, assottigliamento del nocciolo per una maggiore precisione. Possibilità di affilare punte in metallo duro con mola opzionale.



Capacità di affilatura	3 ÷ 13 mm
Inclinazione punta	95° ÷ 135°
Velocità	4400 rpm
Motore	230 V 50 Hz 120 W
Dimensioni	320 x 180 x 190 mm
Peso netto	8,5 kg

A013/26

€ 1260,00

AFFILATRICE PER PUNTE ELICOIDALI

Con pinze ER per le punte e dispositivo inclinazione dei taglienti, assottigliamento del nocciolo per una maggiore precisione.



Capacità di affilatura	13 ÷ 26 mm
Inclinazione punta	118° ÷ 135°
Velocità	4200 rpm
Motore	230 V 50 Hz 0,2 kW
Dimensioni	370 x 165 x 200 mm
Peso netto	24 kg

A0132A

€ 1150,00

AFFILATRICE PER PUNTE ELICOIDALI



Capacità di affilatura	3 ÷ 20 mm
Inclinazione punta	90° ÷ 140°
Velocità	7000 rpm
Motore	230 V 50 Hz 0,6 kW
Dimensioni	500 x 230 x 250 mm
Peso netto	21 kg

A004/14 **NEW** € 1530,00

AFFILATRICE PER FRESE

Con pinze ER, adatta per affilare frese a 2, 3 e 4 taglienti. Possibilità di affilare frese in metallo duro con mola opzionale.



Capacità di affilatura	4 ÷ 14 mm
Velocità	4400 rpm
Motore	230 V 50 Hz 200 W
Dimensioni	350 x 230 x 240 mm
Peso netto	12,6 kg

A004/20 **NEW** € 2240,00

AFFILATRICE PER FRESE

Con pinze ER, adatta per affilare frese a 2, 3 e 4 taglienti. Possibilità di affilare frese in metallo duro con mola opzionale.



Capacità di affilatura	4 ÷ 20 mm
Velocità	4400 rpm
Motore	230 V 50 Hz 200 W
Dimensioni	350 x 230 x 240 mm
Peso netto	16 kg

0804 € 582,00

AFFILATRICE MANUALE PER DISCHI

Capacità di affilatura	Ø 80 ÷ 700 mm
Velocità	2850 rpm
Motore	230 V 50 Hz 0,25 kW
Peso netto	29 kg

A059 € 117,00

AFFILATRICE MULTIFUNZIONE

Ideale per affilare coltelli, forbici e lame.



Capacità di affilatura	3 - 13 mm
Velocità	3000 rpm
Motore	230 V 50 Hz 0,15 kW
Dimensioni	232 x 160 x 110 mm
Vibrazioni	3,9 m/s ²
Livello pressione acustica	86 ±3 db(A)
Livello potenza acustica	95 ±3 db(A)



A003/32CBN € 247,00

MOLA IN CBN

Per punte elicoidali in HSS da 13,1 a 32mm



A003/32SDC € 247,00

MOLA IN SDC

Per punte elicoidali in metallo duro da 13,1mm a 32mm.



A003/13ACBN € 135,00

MOLA IN CBN

Per punte elicoidali in HSS da 3 a 13mm.



A003/13ASDC € 135,00

MOLA IN SDC

Per punte elicoidali in metallo duro da 3 a 13mm.



A013/26M € 176,00

MOLA DIAMANTATA

In CBN per punte elicoidali in HSS.



A0132A/MR € 21,90

MOLA ROSA

Filetto m8, Ø 40 x 38mm interno Ø 26mm.



A0132A/MB € 21,90

MOLA BIANCA

Filetto M8, Ø 40 x 38mm interno Ø 26mm.



0804/MD € 111,00

MOLA DIAMANTATA

125 x 10 x F32 x 8 mm



A059/M € 11,80

SET MOLE



A004/14CBN € 153,00

MOLA IN CBN

Per frese in HSS da 4 a 14mm.



A004/14SDC € 153,00

MOLA IN SDC

Per frese in metallo duro da 4 a 14mm.



A004/20CBN € 305,00

SERIE DI 2 MOLE IN CBN

Per frese in HSS da 4 a 20mm.



A004/20SDC € 305,00

SERIE DI 2 MOLE IN SDC

Per frese in metallo duro da 4 a 20mm.



0691/400V € 2570,00

LEVIGATRICE A NASTRO INCLINABILE



Dimensioni nastro	2000 x 150 mm
Velocità	[2] 18 / 37 mm/sec
Motore trifase	400 V 50 Hz 4 kW
Peso netto	110 kg

0662 € 706,00

LEVIGATRICE A NASTRO INCLINABILE CON BANCO

Banco da assemblare



Dimensioni nastro	1219 x 152 mm
Diametro disco	Ø 230 mm
Dimensioni piano di lavoro	330 x 152 mm
Velocità nastro	330 m/min
Velocità disco	1400 m/min
Dimensioni	710 x 510 x 1000 mm
Motore	230 V 50 Hz 0,75 kW
Peso netto	54 kg

0560
€ 703,00
SMUSSATRICE DA BANCO

SPUN13P € 9,50
INSERTO DI RICAMBIO

Smusso	45° 0 - 5 mm
Velocità	2800 rpm
Motore	230 V 50 Hz 0,25 kW
Dimensione piani	2 - 400 x 50 mm
Dimensioni fresa	Ø 80 mm - Z 8
Inserto	SPUN13P
Peso netto	21 kg

0022
€ 722,00
SMUSSATRICE PORTATILE

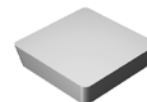
SPUN13P € 9,50
INSERTO DI RICAMBIO

Smusso	15° - 45° 0 - 5 mm
Velocità	2950 rpm
Motore	230 V 50 Hz 0,25 kW
Dimensioni piani	2 - 200 x 50 mm
Dimensioni fresa	Ø 80 mm - Z 8
Inserto	SPUN13P
Peso netto	11,5 kg

0285/75 
€ 5110,00
CALANDRA MOTORIZZATA

A 3 rulli in acciaio con durezza 52HRC, barriera di arresto di emergenza a filo con micro di sicurezza a 3 funzioni, comandi mobili con doppio pedale avanti/indietro e pulsante a fungo di arresto di emergenza.



Lunghezza utile	1300 mm
Spessore max	1.5 mm
Diametro dei rulli	75 mm
Motore trifase	400 V 50 Hz 0.75 kW
Peso netto	375 kg

0334/0750
€ 3810,00
CALANDRA CESOIA PIEGATRICE

Macchina versatile e robusta, adatta per la produzione di prototipi



Lunghezza utile	750 mm
Max spessore di taglio, di piegatura e di calandratura	1,0 mm
Angolo di piegatura	90°
Ø min. di calandratura	44 mm
Dimensioni	980 x 370 x 550 mm
Peso netto	260 kg

0334/1000
€ 4250,00
CALANDRA CESOIA PIEGATRICE

Macchina versatile e robusta, adatta per la produzione di prototipi



Lunghezza utile	1000 mm
Max spessore di taglio, di piegatura e di calandratura	1,0 mm
Angolo di piegatura	90°
Ø min. di calandratura	48 mm
Dimensioni	1335 x 455 x 620 mm
Peso netto	317 kg

**C022/100**

€ 2540,00

CALANDRA

A 3 rulli, rullo centrale smontabile per creazione tubi completi.



Lunghezza massima	1000 mm
Spessore max	2 mm
Diametro dei rulli	60 mm
Peso netto	200 kg

0776

€ 1160,00

CALANDRA MANUALE

A 3 rulli, con banco dotato di un ripiano, rullo centrale smontabile per creazione tubi completi.



Lunghezza massima	1000 mm
Spessore max	0,8 mm
Diametro dei rulli	50 mm
Peso netto	105 kg

0776/610**NEW** € 506,00**CALANDRA MANUALE**

A 3 rulli, da banco, rullo centrale smontabile per creazione tubi completi.



Lunghezza massima	610 mm
Spessore max	0,8 mm
Diametro dei rulli	38 mm
Peso netto	37 kg

0235

€ 241,00

MINI CALANDRA

Dotata di 3 rulli, morsa non inclusa



Lunghezza massima	300 mm
Spessore max	2,5 mm
Diametro dei rulli	30 mm
Peso netto	10 kg

P008/102

€ 2910,00

PIEGATRICE PER LAMIERA

Elevate prestazioni grazie al coltello segmentato ed estraibile, struttura robusta e affidabile

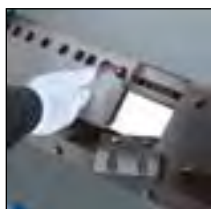

Utile max	1020 mm
Max. spessore piegatura su lamiera ferrosa	2 mm
Max angolo di piegatura	135°
Peso netto	334 kg



0775

€ 1600,00

PIEGATRICE PER LAMIERA



Utile max	1000 mm
Max. spessore piegatura su lamiera ferrosa	1,2 mm
Max angolo di piegatura	140°
Peso netto	130 kg

0483

€ 249,00

MINI PIEGATRICE

Lama intercambiabile, profondità massima di piegatura lato manico 50mm, morsa non inclusa.



Lavoro utile	270 mm
Max. spessore piegatura su lamiera ferrosa	2,5 mm
Peso netto	10 kg

T034/105

€ 2490,00

CESOIA PER LAMIERA CON BANCO

Con goniometro integrato, fine corsa di taglio regolabile e banco in kit di montaggio



Lunghezza utile	1050 mm
Max. spessore taglio su lamiera ferrosa	1,25 mm
Capacità di taglio con regolazione	0 ÷ 500 mm
Dimensioni	1290 x 1300 x 1080 mm
Peso netto	220 kg

T034/065

€ 1430,00

CESOIA PER LAMIERA DA BANCO

Con goniometro integrato e fine corsa di taglio regolabile



Lunghezza utile	650 mm
Max. spessore taglio su lamiera ferrosa	1,5 mm
Capacità di taglio con regolazione	0 ÷ 500 mm
Dimensioni	890 x 1300 x 450 mm
Peso netto	145 kg

0773-

CESOIA A LEVA

0773/10L

€ 111,00

SERIE LAME



0773/05L

€ 84,80

SERIE LAME



Art.	€	Dimensioni	Dimensioni base	Lunghezza leva	Lungh. lama	Taglio piatto	Taglio lamiera	Tondo	Peso netto
0773/05	€ 170,00	290 x 120 x 240 mm	290 x 90 mm	620 mm	130 mm	38 x 3 mm	0,5 ÷ 3 mm	Ø 6 mm	10 kg
0773/10	€ 248,00	420 x 120 x 390 mm	420 x 90 mm	800 mm	250 mm	70 x 3 mm	0,5 ÷ 3 mm	Ø 6 mm	19 kg

**0892****€ 492,00****MINI CESOIA - PIEGATRICE**

Lama intercambiabile, morsa non inclusa



Lavoro utile	200 mm
Max. spessore taglio su lamiera ferrosa	1 mm
Max. spessore piegatura su lamiera ferrosa	1 mm
Peso netto	17 kg

C076/30 FERVIPUS**€ 4050,00****CURVAPROFILATI MOTORIZZATA A 3 RULLI**

Orizzontale e verticale per pieni, tubi e profilati.



Diametro albero dei rulli	30 mm
Diametro rullo superiore	148 mm
Diametro dei rulli inferiori	148 mm
Velocità di rotazione	4,8 ÷ 7,2 m/min
Motore trifase	400 V 50 Hz 1,1 kW
Dimensioni	620 x 1100 x 1360 mm
Peso netto	230 kg

0197**€ 583,00****PIEGATRICE UNIVERSALE**

Per piegatura a freddo, con finecorsa per velocizzare e standardizzare i lavori in serie, con manico ergonomico.



Tondino	Acciaio, Rame 16 mm Ferro battuto 12 mm Alluminio 18 mm
Piatto	30 x 8 mm
Quadro	Acciaio, Rame 13 x 13 mm Ferro battuto 10 x 10 mm Alluminio 15 x 15 mm
Peso netto	22 kg

0668**€ 1380,00****FORNO PER FUCINAZIONE**

Facile da usare, accensione rapida, nessuna emissione nociva. Retro smontabile per scaldare le barre di ferro al centro, isolamento camera in fibro ceramica, completo di regolatore, valvola di non ritorno e termocoppia



Temperatura di esercizio	1300 °C - 1400 °C
Capacità max. di lavoro	Ø 70 mm / ■ 50 mm
Alimentazione	G.P.L.
Consumo	0,05 - 1,5 kg / h
Dimensioni interne	280 x 210 x 100h mm
Dimensioni esterne	400 x 260 x 250h mm
Peso netto	25 kg

0721**NEW € 330,00****CURVAFERRI E PIEGAFERRI MANUALE**

Per piegatura a freddo, con finecorsa per velocizzare e standardizzare i lavori in serie. Leva regolabile in lunghezza, con rulli per tondini e piatti già inclusi per effettuare diversi raggi di curvatura. Possibilità di creare sia pieghe secche che curvature ed utilizzo con tubi.



Diametro dei rulli	2x Ø 24, 30, 37, 43, 49, 62, 75 mm
Tondino	Acciaio, Alluminio, Rame Ø16 mm Inox Ø14 mm
Piatto	10 x 50 mm Spigolo 6 x 50 mm
Quadro	14 x 14 mm
Tubo tondo	G 3/4"
Lunghezza leva	1000 mm Max
Peso netto	30 kg

0102**€ 340,00****PIEGAFERRI**

Per piegatura a freddo e a caldo. Con finecorsa per velocizzare e standardizzare i lavori in serie ed impugnatura ergonomica



Tondino	A freddo 22 mm A caldo 27 mm
Quadro	A freddo 20 mm A caldo 25 mm
Piatto	Acciaio 100 x 8 mm Rame 100 x 15 mm
Peso netto	30 kg

0113 € 330,00

CURVAFERRI

Per curvatura a freddo. Con ferma pezzo ed impugnatura ergonomica



Ferro dolce	A freddo
Tondino	10 mm
Piatto	10 x 30 mm
Quadro	10 mm
Matrici	80 mm 125 mm 200 mm
Peso netto	25 kg

0722 **NEW** € 1320,00

CURVATUBI MANUALE

Per piegatura a freddo, per tubi di grandi dimensioni, con sistema che evita lo schiacciamento, per la realizzazione di curve semplici o complesse, con indicazione dell'angolo di piega, leva inclusa. Funzionamento a cricchetto per esercitare la massima forza.



Matrici	25.4 - 38.1 - 44.5 mm
Raggio min. curvatura	75 - 125 - 150 mm
Spessore max	3 mm
Tubo tondo	Ø20 ÷ 50 mm
Max angolo di piegatura	120°
Lunghezza leva	1000 mm
Peso netto	65 kg

0723 **NEW** € 385,00

CURVATUBI MANUALE PORTATILE

Per piegatura a freddo, con sistema che evita lo schiacciamento, per la realizzazione di curve semplici o complesse.



Matrici	8
Tubo tondo	3/8" - 1/2" - 9/16" - 5/8" - 3/4" - 7/8"
Tubo quadro	3/4" - 1"
Spessore	0.8 ÷ 1.2 mm
Max angolo di piegatura	180°
Lunghezza leva	420 ÷ 600 mm
Peso netto	25 kg

0893 € 548,00

CURVATUBI IDRAULICO 1 1/2" - 2"

Con pompa a 2 velocità



Matrici	1/2" 3/4" 1" 1-1/4" 1-1/2" 2" gas
Forza	10 tons N
Corsa pistone	250 mm
Peso netto	48 kg

0719 **NEW** € 1090,00

CURVATUBI MANUALE

Per piegatura a freddo, con sistema che evita lo schiacciamento, per la realizzazione di curve semplici o complesse, con finecorsa per velocizzare e standardizzare i lavori in serie.



Matrici	14 - 16 - 18 - 20 - 22 - 25 mm
Raggio min. curvatura	4x Ø tubo, 56-100 mm
Spessore max	2 mm
Tubo tondo	acciaio, alluminio, rame Ø25 mm inox Ø22 mm
Quadro	20 x 20 mm
Peso netto	46 kg

0292-

CURVATUBO PER TUBI IN RAME

0292



Art.	€	Misure
0292	€ 16,60	Ø 8 - 10 - 12 mm
0292/14	€ 15,90	Ø 14 mm
0292/16	€ 18,00	Ø 16 mm

**0758****€ 1280,00****TORNIO DA LEGNO**

Con testa girevole, trasmissione a cinghia con pulegge a velocità variabile e banco in ghisa

ACCESSORI INCLUSI

- Contropunta rotante CM 2
- Trascinatore 4 punte CM 2
- Platorello Ø 150 mm
- Espulsore
- Chiavi di servizio



Distanza tra le punte	1100 mm
Altezza punte	185 mm
Diametro massimo tornitura	370 mm
Filetto	1" - 8 TPI
Contropunta	CM 2
Motore	230 V 50 Hz 0,75 kW
Velocità del mandrino	500 ÷ 2000 rpm
Peso netto	120 kg

**0751****€ 850,00****TORNIO DA LEGNO**

Con testa girevole, trasmissione a cinghia con pulegge a velocità variabile e banco in lamiera

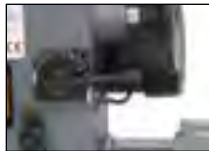
**ACCESSORI INCLUSI**

- Contropunta rotante CM 2
- Trascinatore 4 punte CM 2
- Platorello Ø150 mm
- Espulsore
- Chiave di servizio

Distanza tra le punte	900 mm
Altezza punte	155 mm
Diametro massimo tornitura	310 mm
Filetto	1" - 8 TPI
Contropunta	CM 2
Motore	230 V 50 Hz 0,37 kW
Velocità del mandrino	500 ÷ 2000 rpm
Peso netto	75 kg

**0758/C****€ 371,00****COPIA PER TORNIO LEGNO**

Distanza tra le punte	1000 mm
-----------------------	---------

0648

€ 1000,00

TORNIO DA LEGNO CON COPIA

Con leva per regolare la velocità e zona di lavorazione protetta con riparo mobile interbloccato in plexiglass



Distanza tra le punte	1000 mm
Altezza punte	175 mm
Diametro massimo tornitura	350 mm
Filetto	1" - 8 TPI
Contropunta	2
Motore	230 V 50 Hz 0,75 kW
Velocità del mandrino	500 ÷ 2000 rpm
Dimensioni	1400 x 500 x 1300h mm
Peso netto	68 kg

0497-
TORNIO PER LEGNO

Con cambio velocità cinghia, contropunta in ghisa con sistema di bloccaggio, carrello scorrevole poggia utensile

ACCESSORI INCLUSI

- Contropunta rotante CM 2
- Trascinatore 4 punte CM 2
- Platorello Ø 80 mm
- Espulsore
- Chiavi di servizio

Art.	€	Distanza tra le punte	Altezza punte	Diametro massimo tornitura	Motore	Velocità del mandrino	Filetto	Contropunta	Peso netto
0497/250	€ 620,00	457 mm	125 mm	250 mm	230 V 50 Hz 0.37 kW	(5) 700 - 3000 rpm	1" - 8 TPI	CM 2	33 kg
0497/300	€ 689,00	457 mm	150 mm	300 mm	230 V 50 Hz 0.55 kW	(5) 700 - 3000 rpm	1" - 8 TPI	CM 2	33 kg





0498 **FERVI plus**

€ 9370,00

COMBINATA DA LEGNO & LAVORAZIONI

Sega circolare, squadratrice, incisore, toupie, pialla a filo, pialla spessore, cavatrice e carteggiatrice a rullo a 1500rpm. La macchina può essere divisa velocemente (sei bulloni) in due parti per entrare attraverso piccole aperture.



Dimensioni ingombro	1880 x 1500 x 1050 mm
Altezza piani	840 mm
Motore monofase	3 x 230 V 50 Hz 2.2 kW
Peso	445 kg
Dimensioni imballo	1600 x 1300 x 1010 mm



SEGA CIRCOLARE

Dimensioni tavola principale	1045 x 800 mm
Dimensioni lama	254 x 3,2 x 30 mm 24 Z
Velocità lama	4050 rpm
Altezza di taglio	65 mm 90° - 45 mm 45°



PIALLA FILO SPESSORE

Dimensioni piani	1285 x 310 mm
Sezione albero	Ø 75 mm
Diametro aspirazione	Ø 100 mm
Lame	3
Capacità pialla filo	310 x 5 mm
Capacità spessore	310 x 180 mm
Giri albero	4000 rpm



SQUADRATRICE

Capacità di taglio con squadratrice	1370 mm
Tavola scorrevole	1500 x 840 mm

INCISORE

Dimensioni lama	Ø 80 x 3,2 x 20 mm 8 Z
Velocità lama	6300 rpm



CAVATRICE

Dimensioni piani	150 x 365 mm
Corsa verticale	0 ÷ 80 mm
Corsa longitudinale	0 ÷ 85 mm
Corsa trasversale	0 ÷ 140 mm
Giri albero	4000 rpm



TOUPIE

Sezione albero	Ø 30 mm
Corsa albero	130 mm
Giri albero	1500 / 4000 / 6000 rpm



CARTEGGIATRICE A RULLO

Dimensioni	Ø 100 x 100h mm
Giri albero	1500 rpm



0499

€ 2800,00

PIALLA FILO SPESSORE

Da 310mm con predisposizione al montaggio della cavatrice.



Dimensioni ingombro	1290 x 550 x 1000 mm
Altezza piani	810 mm
Dimensioni piani	310 x 1285 mm
Sezione albero	Ø 75 mm
Lama	3
Capacità spessore	310 x 2,5 x 180h mm
Giri albero	4000 rpm
Motore	230 V 50 Hz 2.2 kW
Peso netto	179 kg

0749

€ 2080,00

PIALLA FILO SPESSORE

Con piani in ghisa



Dimensioni	1050 x 485 x 800h mm
Altezza piani	810 mm
Dimensioni piani	1050 x 250 mm
Albero	Ø 75 mm
Lama	N° 3
Capacità pialla filo	250 x 2 mm
Capacità spessore	250 x 1,2 180h mm
Giri albero	4000 rpm
Motore	230 V - 50H z - 1,5 kW
Peso netto	155 kg

0517A

€ 868,00

PIALLA SPESSORE

Con piano di lavoro in granito



Dimensioni	710 x 640 x 400 mm
Dimensioni piano di lavoro	330 x 238 mm
Albero	Ø 51.5 mm
Lama	2
Capacità spessore	330 x 2.4 x 152 mm
Giri albero	8500 rpm
Motore	230 V 50 Hz 1.5 kW
Peso netto	35 kg





0686/200

€ 592,00

PIALLA FILO SPESSORE

Con piani in alluminio



Dimensioni	770 x 430 x 450h mm
Altezza piani	360 mm
Dimensioni piani	737 x 210 mm
Albero	Ø 50 mm
Lama	N° 2
Capacità pialla filo	204 x 2 mm
Capacità spessore	204 x 2 x 120h mm
Giri albero	8000 rpm
Motore	230 V 50 Hz 1,25 kW
Peso netto	25 kg

0749/M

€ 470,00

CAVATRICE

Con piani in ghisa



Mandrino	Ø 16 mm
Dimensioni tavola	370 x 150 mm
Corsa verticale	0 - 80 mm
Corsa laterale	0 - 140 mm
Interasse fori	3 x 165 mm
Peso netto	26 kg

0749/MC

€ 128,00

MANDRINO "WESTCOTT"



Capacità	16 mm
Attacco femmina	M20 x 1,5 Sx / Left
Misure	Ø 55 x 68,5 mm

M057/16

€ 130,00

MANDRINO "WESTCOTT"



Capacità	16 mm
Attacco femmina	B18
Misure	Ø 60 x 65 mm

0697

€ 57,50

SERIE CALIBRI MAGNETICI UNIVERSALI



Per coltelli pialla con alberi	Ø 75 ÷ 125 mm
--------------------------------	---------------

0499/C

€ 84,00

SERIE COLTELLI

Per pialla filo spessore



Misure	310 x 30 x 3 mm
--------	-----------------

0749/C

€ 65,10

SERIE COLTELLI

Per pialla filo spessore



Misure	250 x 30 x 3 mm
--------	-----------------

0517/59

€ 61,30

SERIE COLTELLI

Per pialla filo spessore



Misure	335 x 12 x 1.5 mm
--------	-------------------

0686/200C

€ 38,60

SERIE COLTELLI

Per pialla filo spessore



Misure	210 x 22 x 2 mm
--------	-----------------

0559

€ 1560,00

2 IN 1 TOUPIE E CARTEGGIATRICE A RULLO

Per fresatura e foratura su legno, levigatura montando carta abrasiva



Motore	230V 50Hz 1,5kW
Giri albero	1500 / 4000 / 6000 rpm
Diametro albero	30 mm
Corsa albero	105 mm
Diametro massimo fresa	160 mm
Piani in ghisa	600 x 400 mm
Piano scorrevole in ghisa	400 x 250 mm
Corsa del carrello	700 mm
Altezza piani	850 mm
Dimensioni	74 x 66 x 98 cm
Livello pressione acustica posto operatore	85.3 ± 2.94 dB(A)
Livello potenza acustica	98.3 ± 2.94 dB(A)
Peso netto	110 kg

0559/T

€ 159,00

RULLO PER CARTEGGIARE

Nastro abrasivo non incluso

0504 FERVI plus

€ 5920,00

SEGA CIRCOLARE SQUADRATRICE INCISORE TOUPIE CARTEGGIATRICE

Carrello a squadrare, incisore, toUPIE e carteggiatrice a 1500rpm.

Altezza piani	840 mm
Dimensioni ingombro	1670 x 1200 x 1050 mm
SEGA CIRCOLARE	
Dimensioni tavola principale	1045 x 800 mm
Dimensioni lama	Ø 254 x 3.2 x 30 mm 24 Z
Velocità lama	4050 rpm
Altezza di taglio	65 mm 90° - 45 mm 45°
SQUADRATRICE	
Capacità di taglio con squadratrice	1070 mm
Tavola scorrevole	1200 x 840 mm
INCISORE	
Dimensioni lama	Ø 80 x 3.2 x 20 mm 8 Z
Velocità lama	6300 rpm
TOUPIE	
Sezione albero	Ø 30 mm
Corsa albero	130 mm
Giri albero	1500 / 4000 / 6000 rpm
CARTEGGIATRICE A RULLO	
Dimensioni	Ø 100 x 100h mm
Giri albero	1500 rpm
Motore	2 x 230 V 50 Hz 2.2 kW
Peso netto	250 kg

0665

€ 3240,00

SEGA CIRCOLARE SQUADRATRICE PARZIALMENTE MONTATA

Lama	250 x 3 x 30 mm Z 40
Velocità lama	2800 rpm
Dimensioni tavola principale	800 x 560 mm
Dimensioni allungamento tavola	800 x 305 mm
Altezza tavola	860 mm
Taglio a 45°	60 mm
Taglio a 90°	75 mm
Tavola scorrevole	500 x 600 mm
Dimensioni ingombro	1860 x 2030 x 1070h mm
Motore	230 V 50 Hz 2,2 kW
Capacità di taglio con squadratrice	1460 mm
Peso netto	230 kg



**0656/254****€ 2700,00****SEGA CIRCOLARE SQUADRATRICE**

Da 254mm, parzialmente montata.



Dimensioni lama	254 x 30 x 3,2 mm 40 Z
Velocità lama	4000 rpm
Dimensioni tavola principale	790 x 350 mm
Dimensioni allungamento tavola	350 x 350 mm
Altezza tavola	850 mm
Capacità di taglio a 90°	80 mm
Capacità di taglio a 45°	56 mm
Tavola scorrevole	1320 x 238 mm
Motore	230 V 50 Hz 2,2 kW
Capacità di taglio con squadratrice	1250 mm
Peso netto	150 kg

**0656/310****€ 3110,00****SEGA CIRCOLARE SQUADRATRICE**

Da 310mm, parzialmente montata.



Dimensioni lama	315 x 30 x 3,2 mm 40 Z
Velocità lama	4000 rpm
Dimensioni tavola principale	790 x 350 mm
Dimensioni allungamento tavola	350 x 350 mm
Altezza tavola	850 mm
Capacità di taglio a 90°	100 mm
Capacità di taglio a 45°	70 mm
Tavola scorrevole	1320 x 238 mm
Motore	230 V 50 Hz 2,2 kW
Capacità di taglio con squadratrice	1400 mm
Peso netto	175 kg

**0280****€ 995,00****BANCO SEGA**

Professionale, Dotato di lama con riporto in metallo duro con protezioni lama, guida-pezzo, tavola mobile, ruote per lo spostamento.

Dimensioni tavola	800 x 550 mm
Prolunga tavola	800 x 550 mm
Altezza tavola	810 mm
Spessore lamiera	2 mm
Capacità di taglio a 90°	90 mm
Capacità di taglio a 45°	50 mm
Dimensioni lama	315 x 3 x 30 mm Z 36
Inclinazione lama	45°
Corsa piano scorrevole	1160 mm
Dim. piano scorrevole	230 x 230 mm
Velocità motore	2800 rpm
Motore	230 V 50 Hz 2,2 kW
Peso netto	60 kg



0871
€ 617,00
TRONCATRICE RADIALE PER LEGNO

Dotata di indicatore laser della linea di taglio



Disco	Ø 305 x 30 x 3,2 mm Z 40
Taglio massimo 0° - 90°	340 x 100 mm
Taglio massimo 45° - 90°	240 x 100 mm
Spostamento radiale	215 mm
Motore	230 V 50 Hz 2 kW
Velocità motore	4500 rpm
Peso netto	25 kg

0870/250
€ 435,00
TRONCATRICE PER LEGNO

Con tavola supplementare superiore per funzionamento come sega da banco.



Disco	Ø 250 x 30 x 2,5 mm Z 36
Taglio massimo 0° - 90°	75 x 130 mm
Taglio massimo 45° - 45°	75 x 50 mm
Taglio massimo 45° - 90°	75 x 90 mm
Taglio massimo 0° - 45°	50 x 130 mm
Taglio massimo tavola superiore	40 mm
Motore	230 V 50 Hz 1,8 kW
Velocità motore	4500 rpm
Velocità periferica disco	59 m/s
Peso netto	15,5 kg

0365
€ 250,00
SUPPORTO UNIVERSALE PER TRONCATRICE PORTATILE

Pieghevole



Altezza tavola	860 mm
Altezza prolunghe	950 ÷ 1100 mm
Lunghezza supporto	1200 mm
Lunghezza bracci estensibili	1350 ÷ 3000 mm
Misure morsetti	500 x 35 mm
Dimensioni	1300 x 230 x 950h mm
Portata	250 kg
Peso netto	18 kg



SEGHE A NASTRO PER LEGNO

Dimensioni tavola (mm)

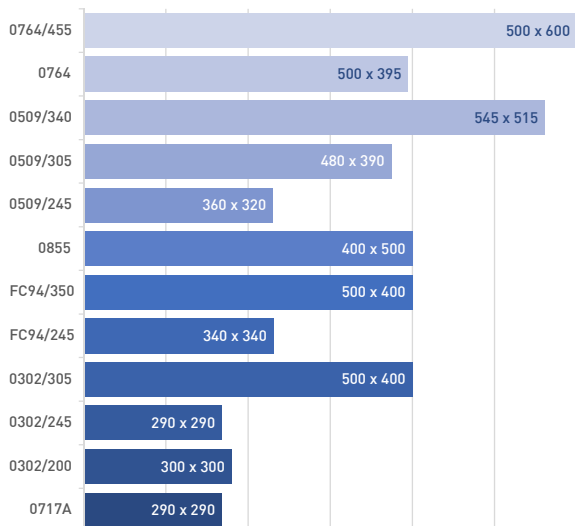

Capacità di taglio (mm)

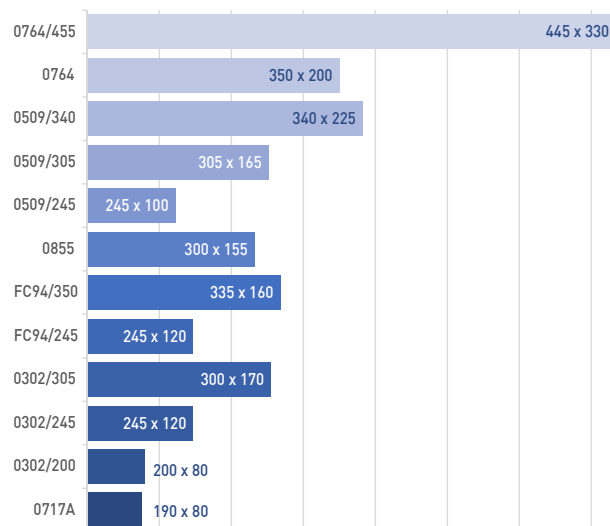

Potenza (kW)

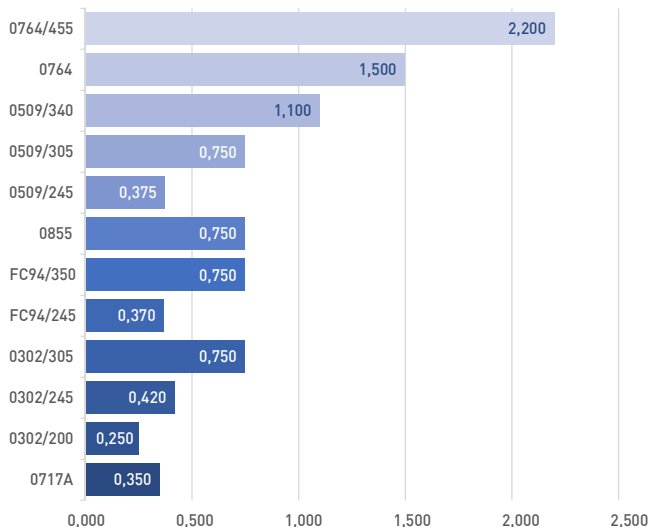

Inclinazione tavola

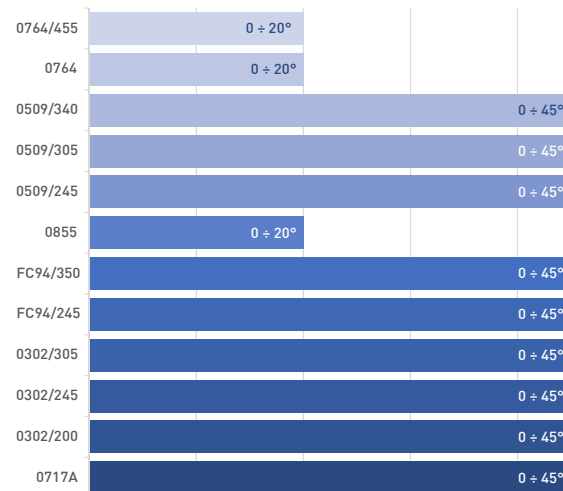

Dimensioni lama

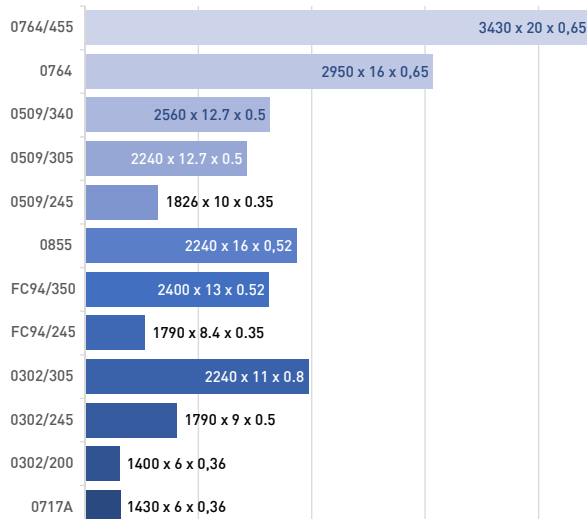

0764/455

€ 2520,00

SEGA A NASTRO PER LEGNO



Volano	Ø 455 mm
Capacità di taglio	445 x 330h mm
Lama	3430 x 20 x 0,65 mm T4
Dimensioni tavola	500 x 600 x 40h mm
Velocità di taglio	10 m/s
Inclinazione tavola	0 ÷ 20°
Altezza tavola	950 mm
Dimensioni	1000 x 900 x 1860h mm
Motore	230 V 50 Hz 2,2 kW
Peso netto	200 kg

0764

€ 1690,00

SEGA A NASTRO PER LEGNO



Volano	Ø 405 mm
Capacità di taglio	350 x 200h mm
Lama	2950 x 16 x 0,65 mm T4
Dimensioni tavola	500 x 395 mm
Velocità di taglio	10 m/s
Inclinazione tavola	0 ÷ 20°
Altezza tavola	995 mm
Motore	230 V 50 Hz 1,5 kW
Dimensioni	750 x 650 x 1710 h mm
Peso netto	130 kg

**0509/340****€ 1430,00****SEGA A NASTRO PER LEGNO**

Con accessorio per tagli circolari, lampada a Led e cassetto raccogli segatura.



Volano	Ø 347 mm
Capacità di taglio	340 x 225 mm
Lama	2560 x 12.7 x 0.5 mm T4
Dimensioni tavola	545 x 515 mm
Velocità di taglio	6-12 m/s
Inclinazione tavola	0-45°
Altezza tavola	1010 mm
Motore	230 V 50 Hz 1.1 kW
Dimensioni	900 x 670 x 1720 h mm
Peso netto	70 kg

**0509/305****€ 1240,00****SEGA A NASTRO PER LEGNO**

Con accessorio per tagli circolari, lampada a Led e cassetto raccogli segatura.



Volano	Ø 314 mm
Capacità di taglio	305 x 165 mm
Lama	2240 x 12.7 x 0.5 mm T4
Dimensioni tavola	480 x 390 mm
Velocità di taglio	6-12 m/s
Inclinazione tavola	0 ÷ 45°
Altezza tavola	990 mm
Motore	230 V 50 Hz 0.75 kW
Dimensioni	700 x 600 x 1585 h mm
Peso netto	62 kg

**0509/245****€ 808,00****SEGA A NASTRO PER LEGNO**

Con accessorio per tagli circolari, lampada a Led e cassetto raccogli segatura.



Volano	Ø 254 mm
Capacità di taglio	245 x 100 mm
Lama	1826 x 10 x 0.35 mm T6
Dimensioni tavola	360 x 320 mm
Velocità di taglio	6.7 ÷ 13.3 m/s
Inclinazione tavola	0 ÷ 45°
Altezza tavola	925 mm
Motore	230V 50Hz 0.375kW
Dimensioni	750 x 480 x 1420 mm
Peso netto	37 kg



0855

€ 1030,00

SEGA A NASTRO PER LEGNO

Volano	Ø 315 mm
Lama	2240 x 16 x 0,52 mm T4
Capacità di taglio	300 x 155 mm
Dimensioni tavola	400 x 500 mm
Velocità di taglio	6 - 12 m/s 370 - 800 rpm
Inclinazione tavola	0 ÷ 20°
Altezza tavola	1010 mm
Motore	230 V 50 Hz 0,75 kW
Dimensioni	650 x 650 x 1610 h mm
Peso netto	75 kg

FC94/350

€ 1250,00

SEGA A NASTRO PER LEGNO

Volano	Ø 350 mm
Capacità di taglio	335 x 160 mm
Lama	2400 x 13 x 0.52 mm T4
Dimensione tavola	500 x 400 mm
Velocità di taglio	10 ÷ 12 m/s
Inclinazione tavola	0 ÷ 45°
Altezza tavola	1015 mm
Motore	230 V 50 Hz 0.75 kW
Dimensioni	730 x 620 x 1540 h mm
Peso netto	79 kg

FC94/245

€ 630,00

SEGA A NASTRO PER LEGNO

Volano	Ø 255 mm
Capacità di taglio	245 x 120 mm
Lama	1790 x 8.4 x 0.35 mm T6
Dimensioni tavola	340 x 340 mm
Velocità di taglio	11 ÷ 16 m/s
Inclinazione tavola	0 ÷ 45°
Altezza tavola	1000 mm
Motore	230 V 50 Hz 0.37 kW
Dimensioni	420 x 250 x 800 h mm
Peso netto	29 kg





0302/305

€ 780,00

SEGA A NASTRO PER LEGNO

Con tavola in alluminio, per tagliare pezzi con sezioni rettangolari, circolari e curvilinee. Dispositivo di protezione lama



Volano	Ø 315 mm
Capacità di taglio	300 x 170 mm
Lama	2240 x 11 x 0.8 mm T6
Dimensioni tavola	500 x 400 mm
Velocità di taglio	6 ÷ 12 m/s
Inclinazione tavola	0° ÷ 45°
Altezza tavola	960 mm
Motore	230 V 50 Hz 0.75 kW
Dimensioni	80 x 500 x 1580 h mm
Peso netto	58 kg

0302/245

€ 512,00

SEGA A NASTRO PER LEGNO

Con tavola in alluminio, per tagliare pezzi con sezioni rettangolari, circolari e curvilinee. Dispositivo di protezione lama



Volano	Ø 255 mm
Capacità di taglio	245 x 120 mm
Lama	1790 x 9 x 0.5 mm T6
Dimensioni tavola	290 x 290 mm
Velocità di taglio	11 ÷ 16 m/s
Inclinazione tavola	0° ÷ 45°
Altezza tavola	1000 mm
Motore	230 V 50 Hz 0.42 kW
Dimensioni	600 x 400 x 1480 h mm
Peso netto	28 kg

0302/200

€ 350,00

SEGA A NASTRO PER LEGNO

Con tavola orientabile in acciaio. Taglio pezzi con sezioni circolari e rettangolari. Dispositivo di protezione lama



Volano	Ø 210 mm
Capacità di taglio	200 x 80h mm
Lama	1400 x 6 x 0,36 mm T6
Dimensioni tavola	300 x 300 mm
Velocità di taglio	15 m/s
Inclinazione tavola	0 ÷ 45°
Dimensioni	450 x 390 x 680 h mm
Motore	230 V 50 Hz 0.25 kW
Peso netto	17 kg

0717A

€ 334,00

SEGA A NASTRO PER LEGNO

Con tavola di lavoro orientabile e goniometro per alta precisione. Dispositivo di protezione lama



Volano	Ø 200 mm
Lama	1430 x 6 x 0,36 mm T6
Capacità di taglio	190 x 80h mm
Dimensioni tavola	290 x 290 mm
Velocità di taglio	13,7 m/s
Inclinazione tavola	0 ÷ 45°
Motore	230 V 50 Hz 0.35 kW
Dimensioni	430 x 355 x 665 h mm
Peso netto	17 kg

0523
€ 427,00
LEVIGATRICE A NASTRO DA BANCO INCLINABILE

Utilizzabile con nastro in orizzontale o verticale. Con supporto ferma pezzo, nastro e disco abrasivi. Tavola di lavoro inclinabile in fusione di alluminio. Rullo trainato in alluminio su cuscinetti. Basamento pesante adatto a lavori gravosi. Da utilizzarsi esclusivamente per la lavorazione del legno e materiali plastici.



Dimensioni	530 x 430 x 330 mm
Motore	230V 50Hz 375 W
Nastro	914 x 100 mm
Velocità nastro	336 m/min
Grana nastro	80
Diametro disco	Ø 150 mm
Grana disco	80
Velocità di rotazione	1850 rpm
Inclinazione tavola	0 ÷ 45°
Dimensioni tavola	176 x 136 mm
Peso netto	19.5 kg

0505
€ 285,00
LEVIGATRICE A NASTRO DA BANCO INCLINABILE

Utilizzabile con nastro in orizzontale o verticale. Con supporto ferma pezzo, nastro e disco abrasivi. Tavola di lavoro inclinabile in fusione di alluminio. Rullo trainato in alluminio su cuscinetti. Da utilizzarsi esclusivamente per la lavorazione del legno e materiali plastici.



Dimensioni	460 x 380 x 270h mm
Motore	230V 50 Hz 500 W
Nastro	914 x 100 mm
Velocità nastro	420 m/min
Grana nastro	80
Diametro disco	Ø 150 mm



Grana disco	80
Velocità di rotazione	2850 rpm
Inclinazione tavola	0 ÷ 45°
Dimensioni tavola	225 x 155 mm
Peso netto	18 kg

0564
NEW
€ 291,00
LEVIGATRICE A NASTRO DA BANCO INCLINABILE

Utilizzabile con nastro in orizzontale o verticale. Con supporto ferma pezzo, nastro e disco abrasivi. Tavola di lavoro inclinabile in estruso di alluminio. Sistema rapido di cambio del nastro. Rullo trainato in plastica su cuscinetti. Da utilizzarsi esclusivamente per la lavorazione del legno e materiali plastici.



Dimensioni	470 x 360 x 290 mm
Motore	230V 50 Hz 370 W
Nastro	914 x 100 mm
Velocità nastro	450 m/min
Grana nastro	80
Diametro disco	Ø 150 mm
Grana disco	80
Velocità di rotazione	2980 rpm
Inclinazione tavola	0 ÷ 45°
Dimensioni tavola	226 x 160 mm
Peso netto	16,5 kg





0138

€ 592,00

LEVIGATRICE A NASTRO VERTICALE E DISCO

Con piani di lavoro inclinabili



Dimensioni	630 x 370 x 495h mm
Nastro	25 x 1075 mm
Velocità nastro	8,5 m/s
Diametro disco	200 mm
Motore	230 V 50 Hz 0,45 kW 1450 rpm
Dimensioni tavola nastro	180 x 150 mm
Dimensione tavola disco	250 x 120 mm
Peso netto	26 kg

0144

€ 470,00

SEGHETTO A LAMA VIBRANTE A VELOCITÀ VARIABILE

Con lampada Led. piano inclinabile, struttura robusta, adatto al taglio di balsa, compensati, legni leggermente più duri, plastica e metalli non ferrosi.

0753/L € 4,91
SERIE LAME

0753/A € 14,20
ADATTATORE LAMA



Capacità di taglio	457 x 50h mm
Lunghezza lama	127 mm
Oscillazioni	550 ÷ 1650 rpm
Dimensioni piano	480 x 250 mm
Inclinazione tavola	0 ÷ 45° sx
Dimensioni base	220 x 420 mm
Motore	230 V 50 Hz 0,12 kW
Peso netto	16 kg

0765

€ 261,00

SEGHETTO A LAMA VIBRANTE A VELOCITÀ VARIABILE

Piano inclinabile, struttura robusta, adatto al taglio di balsa e compensati

0753/L € 4,91
SERIE LAME

0753/A € 14,20
ADATTATORE LAMA



Capacità di taglio	400 x 50h mm
Lunghezza lama	125 mm
Oscillazioni	800 ÷ 1400 rpm
Dimensioni piano	410 x 250 mm
Inclinazione tavola	0 ÷ 45° sx
Dimensioni base	230 x 390 mm
Motore	230 V 50 Hz 0,12 kW
Temperatura di esercizio	da -5°C a +50°C
Peso netto	14 kg

0720

€ 58,80

TAGLIA CORNICE

Con regolazione profondità di taglio, Leva selezione angoli

0720/L € 9,20
LAMA



Altezza di taglio	110 mm
Larghezza di taglio	120 mm
Inclinazione di taglio	0° ± 45°
Base	400 x 80 mm
Dimensioni lama	550 x 45 mm
Peso netto	4 kg

S015
€ 118,00
SPACCALEGNA MANUALE

A pedale per spaccare la legna da camino in piccoli pezzi per accendere il fuoco



Capacità di lavoro	Ø 254 x 460 mm
Forza di spinta	1,2 ton
Dimensioni lama	100 x 80h mm
Peso netto	8,5 kg

S009
€ 1470,00
SPACCALEGNA VERTICALE

Da 7 tonnellate con cuneo a croce



Capacità di lavoro in altezza	120 ÷ 540 mm
Capacità di lavoro	Ø 50 ÷ 320 mm
Forza di spinta	7 ton
Motore	230 V 50 Hz 3 kW
Giri motore a vuoto	2950 rpm
Peso netto	120 kg





0496

€ 775,00

ASPIRATORE PER TRUCIOLI



Diametro aspirazione	3 x Ø 100 mm
Portata d'aria	3900 m ³ / h
Motore	230 V 50 Hz 2.2 kW
Filtro in tessuto	Ø 510 mm
Dimensioni	1450 x 800 x 2000 mm
Peso netto	48 kg



0759

€ 669,00

ASPIRATORE PER TRUCIOLI PARZIALMENTE ASSEMBLATO



Diametro aspirazione	2 x Ø 100 mm
Portata d'aria	2500 m ³ / h
Capacità filtrante	5 micron
Filtro in tessuto	Ø 510 mm
Velocità motore	2950 rpm
Depressione	1,95 kPa
Motore	230 V 50 Hz 1.5 kW
Dimensioni	840 x 560 x 1800 h mm
Peso netto	40 kg



0756

€ 400,00

ASPIRATORE PER TRUCIOLI

Parzialmente assemblato



Diametro aspirazione	100 mm
Portata d'aria	850 m ³ / h
Capacità filtrante	5 micron
Filtro in tessuto	Ø 370 mm
Velocità motore	2950 rpm
Depressione	1,08 kPa
Motore	230 V 50 Hz 0.75 kW
Dimensioni	500 x 600 x 1700 h mm
Peso netto	23 kg



0507

€ 296,00

ASPIRATORE PER TRUCIOLI

Parzialmente assemblato



Diametro aspirazione	100 mm
Portata d'aria	900 m ³ / h
Capacità filtrante	5 micron
Filtro in tessuto	Ø 320 mm
Velocità motore	2840 rpm
Depressione	0,70 kPa
Motore	230 V 50 Hz 0.55 kW
Dimensioni	500 x 600 x 1700 h mm
Peso netto	18 kg



0495

€ 399,00

ASPIRATORE PORTATILE

Con ruote per seghe a nastro e troncatrici per legno



Diametro aspirazione	100 mm
Portata d'aria	830 m ³ / h
Filtro in tessuto	Ø 380 mm
Motore	230 V 50 Hz 0.75 kW
Dimensioni	395 x 325 x 350 mm
Peso netto	14 kg

0759/F € 29,10

SACCO FILTRAGGIO



Dimensioni Ø 510 mm x 855h mm

0759/S € 53,60

SERIE SACCHI IN PLASTICA



10 Pcs

Dimensioni Ø 510 mm x 855h mm

0756/F € 23,50

SACCO FILTRAGGIO



Dimensioni Ø 370 mm x 590h mm

0756/S € 44,20

SERIE SACCHI IN PLASTICA



10 Pcs

Dimensioni Ø 370 mm x 590h mm

0756/T € 40,60

TUBO SNODATO ESTENSIBILE

Con anima in metallo



Lunghezza massima 2 m
Diametro 100 mm

0756/Y € 20,00

RACCORDO A Y



Diametro 100 mm

0507/Y **NEW** € 5,00

RACCORDO A Y



Dimensioni 150 x 110 x 170h mm
Diametro aspirazione 2 x Ø 35 mm
Diametro 100 mm

0507/14 € 23,70

SERIE SACCHI IN PLASTICA



10 Pcs

Dimensioni Ø 330 mm x 500h mm

0507/15 € 43,90

SACCO FILTRAGGIO



Dimensioni Ø 320 mm x 590h mm

0507/07 € 26,10

TUBO SNODATO

Con anima in metallo



Lunghezza 2 m mm
Diametro 100 mm

0507/4R € 8,40

**RACCORDO DI RIDUZIONE A 4
DIAMETRI**

Riduzione da tubo di 100 mm a: 70 mm 50 mm 40 mm 35 mm



Diametro 100 mm

0495/24 € 18,80

SACCO FILTRAGGIO



Dimensioni Ø380 mm x 530h mm



M011-

PRO

MORSA DI PRECISIONE

Adatte per lavori dove sono richiesti precisione, affidabilità, reperibilità e bloccaggio sicuro. Indicata per lavori di fresatura di precisione e rettifica sia su macchine manuali che centri di lavoro CNC. Superfici di scorrimento rettificate. Dotate di ganasce prismatiche discendenti all'atto del serraggio. Con elementi di fissaggio e chiavi di regolazione. Precisione 0,02mm e durezza 57-62 HRC

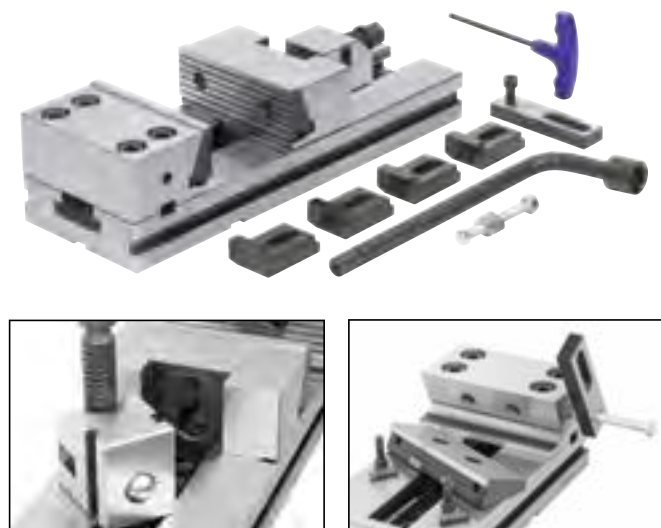
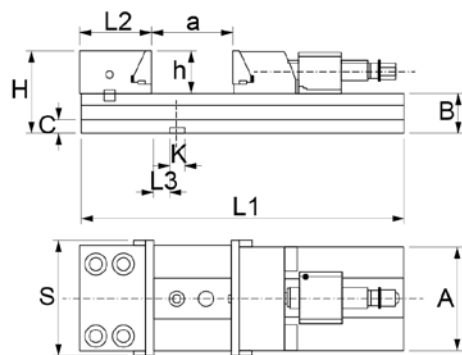

Art.	€	Dimensioni ganasca	S	A	B	C	H	L1	L2	L3	h	K h7	a	Peso netto
M011/125/150	€ 1060,00	125 x 50h mm	125 mm	125 mm	40 mm	15 mm	90 mm	350 mm	80 mm	25,6 mm	50 mm	16 mm	150 mm	19 kg
M011/150/210	€ 1220,00	150 x 60h mm	150 mm	150 mm	50 mm	20 mm	110 mm	435 mm	93 mm	25,6 mm	60 mm	16 mm	210 mm	35 kg
M011/150/300	€ 1520,00	150 x 60h mm	150 mm	150 mm	50 mm	20 mm	110 mm	525 mm	93 mm	25,6 mm	60 mm	16 mm	300 mm	35 kg

M028-

PRO

MORSA DI PRECISIONE

Adatte per lavori dove sono richiesti precisione, affidabilità, reperibilità e bloccaggio sicuro. Indicata per lavori di fresatura di precisione e rettifica sia su macchine manuali che centri di lavoro CNC. Superfici di scorrimento rettificate. Dotate di ganasce prismatiche discendenti all'atto del serraggio. Con elementi di fissaggio e chiavi di regolazione. Precisione 0,02mm e durezza 57-62 HRC

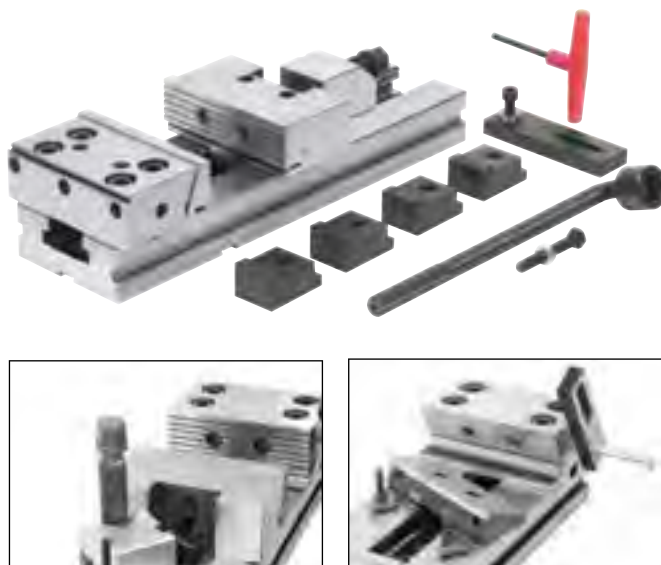
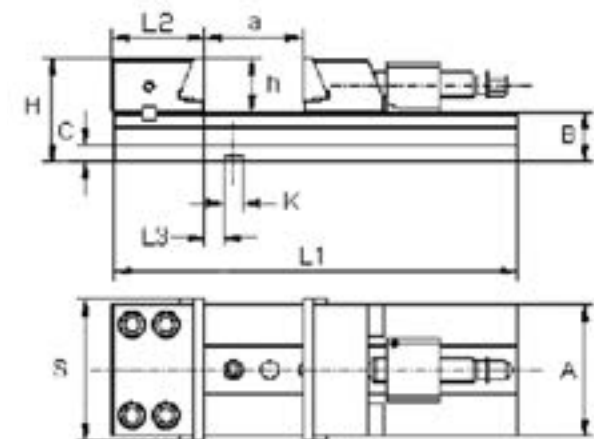

Art.	€	Dimensioni ganasca	S	A	B	C	H	L1	L2	L3	h	K h7	a	Peso netto
M028/100/100	€ 761,00	100 x 30h mm	100 mm	75 mm	35 mm	15 mm	65 mm	270 mm	77,9 mm	25,6 mm	30 mm	16 mm	100 mm	7 kg
M028/125/150	€ 827,00	125 x 40h mm	125 mm	95 mm	40 mm	15 mm	80 mm	345 mm	77,9 mm	25,6 mm	40 mm	16 mm	150 mm	13 kg
M028/150/200	€ 987,00	150 x 50h mm	150 mm	125 mm	50 mm	20 mm	100 mm	420 mm	89,4 mm	25,6 mm	50 mm	16 mm	200 mm	26 kg
M028/150/300	€ 1060,00	150 x 50h mm	150 mm	125 mm	50 mm	20 mm	100 mm	520 mm	89,4 mm	25,6 mm	50 mm	16 mm	300 mm	30 kg
M028/150/400	€ 1220,00	150 x 50h mm	150 mm	125 mm	50 mm	20 mm	100 mm	620 mm	89,4 mm	25,6 mm	50 mm	16 mm	400 mm	34 kg
M028/175/200	€ 1220,00	175 x 60h mm	175 mm	145 mm	58 mm	20 mm	118 mm	455 mm	96,9 mm	25,6 mm	60 mm	16 mm	200 mm	40 kg
M028/175/300	€ 1260,00	175 x 60h mm	175 mm	145 mm	58 mm	20 mm	118 mm	555 mm	96,9 mm	25,6 mm	60 mm	16 mm	300 mm	43 kg
M028/175/400	€ 1410,00	175 x 60h mm	175 mm	145 mm	58 mm	20 mm	118 mm	655 mm	96,9 mm	25,6 mm	60 mm	16 mm	400 mm	50 kg
M028/175/500	€ 1580,00	175 x 60h mm	175 mm	145 mm	58 mm	20 mm	118 mm	755 mm	96,9 mm	25,6 mm	60 mm	16 mm	500 mm	50 kg
M028/200/300	€ 1900,00	200 x 65h mm	200 mm	170 mm	70 mm	26 mm	135 mm	595 mm	113,4 mm	25,6 mm	65 mm	16 mm	300 mm	69 kg
M028/200/400	€ 1950,00	200 x 65h mm	200 mm	170 mm	70 mm	26 mm	135 mm	695 mm	113,4 mm	25,6 mm	65 mm	16 mm	400 mm	74 kg
M028/200/500	€ 2350,00	200 x 65h mm	200 mm	170 mm	70 mm	26 mm	135 mm	795 mm	113,4 mm	25,6 mm	65 mm	16 mm	500 mm	79 kg
M028/200/600	€ 2590,00	200 x 65h mm	200 mm	170 mm	70 mm	26 mm	135 mm	895 mm	113,4 mm	25,6 mm	65 mm	16 mm	600 mm	84 kg

M011-xG

PRO

GANASCE DI RICAMBIO



Art.	€	Descrizione	Dimensioni ganascia
M011/125GP	€ 227,00	Ganascia prismatica	125 x 40h mm
M011/125GR	€ 381,00	Coppia ganasce rigate	125 x 40h mm
M011/150GP	€ 273,00	Ganascia prismatica	150 x 45h mm
M011/150GR	€ 407,00	Coppia ganasce rigate	150 x 45h mm



M028-xG

PRO

GANASCE PRISMATICHE DI RICAMBIO



Art.	€	Dimensioni
M028/100GP	€ 218,00	100 x 24,5h mm
M028M029/125GP	€ 228,00	125 x 32h mm
M028M029/150GP	€ 246,00	150 x 40h mm
M028/175GP	€ 273,00	175 x 43h mm
M028/200GP	€ 303,00	200 x 53h mm

M028-xGR

NEW PRO

GANASCE RIGATE DI RICAMBIO



Art.	€	Dimensioni ganascia
M028/100GR	€ 218,00	100 x 30h mm
M028/125GR	€ 228,00	125 x 40h mm
M028/150GR	€ 246,00	150 x 50h mm
M028/175GR	€ 273,00	175 x 60h mm
M028/200GR	€ 303,00	200 x 65h mm

M061

PRO € 427,00

MORSA DI PRECISIONE CON BARRA SENO

Con chiusura a vite, barra seno ad apertura longitudinale. Accoppiamenti rettificati con alta precisione. Precisione indicata su parallelismo e quadratura. Ideale per lavori di rettifica, elettroerosione, fresatura e nei sistemi di misurazione

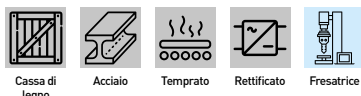

Lunghezza morsa	235 mm
Dimensioni ganascia	88 x 40 h mm
Interasse dei perni	100 mm
Apertura	120 mm
Precisione	0,005 mm
Inclinazione	0° ÷ 45°
Peso netto	12,5 kg



M012-

PRO

MORSA DI PRECISIONE

A chiusura rapida, Accoppiamenti rettificati con alta precisione. Precisione indicata su parallelismo e quadratura. Ideale per lavori di rettifica, elettroerosione, fresatura e nei sistemi di misurazione

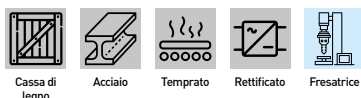

Art.	€	Dimensioni	Apertura	Altezza ganascia	Precisione
M012/038	€ 85,80	38 x 105 x 45h mm	44 mm	25 mm	0,005 mm
M012/050	€ 89,60	50 x 140 x 50h mm	65 mm	25 mm	0,005 mm
M012/080	€ 217,00	73 x 190 x 67h mm	110 mm	35 mm	0,005 mm
M012/100	€ 303,00	100 x 245 x 90h mm	125 mm	45 mm	0,005 mm



M023-**PRO****MORSA A MACCHINA CON BASE GIREVOLE 360°**

Con ganasce intercambiabili in acciaio temprate e rettificare. Parti di scorrimento rettificare. Vite completamente coperta. Con manovella



Art.	€	Ganasce	Apertura	Dimensioni	Dimensioni base	Interasse fori	Cava	Peso netto
M023/100	€ 213,00	100 x 35 mm	80 mm	310 x 165 x 130h mm	215 x 165 mm	195 mm	14 mm	11 kg
M023/125	€ 254,00	125 x 40 mm	100 mm	355 x 190 x 127h mm	215 x 165 mm	195 mm	14 mm	15 kg
M023/160	€ 344,00	160 x 50 mm	125 mm	422 x 235 x 162h mm	300 x 235 mm	275 mm	18 mm	30 kg
M023/200	€ 433,00	200 x 61 mm	160 mm	490 x 270 x 175h mm	360 x 280 mm	315 mm	18 mm	47 kg

M014-**NEW****MORSA A MACCHINA CON BASE GIREVOLE 360°**

Con ganasce intercambiabili in acciaio temprate e rettificare. Parti di scorrimento rettificare. Vite completamente coperta. Con manovella



Art.	€	Ganasce	Apertura	Dimensioni	Dimensioni base	Interasse fori	Cava	Peso netto
M014/080	€ 105,00	80 x 30 mm	60 mm	195 x 110 x 91h mm	110 x 154 mm	130 mm	14 mm	4,5 kg
M014/100	€ 137,00	100 x 35 mm	75 mm	242 x 129 x 106h mm	129 x 186 mm	160 mm	14 mm	9 kg
M014/125	€ 190,00	125 x 40 mm	95 mm	285 x 166 x 126h mm	166 x 210 mm	185 mm	14 mm	14 kg
M014/160	€ 264,00	160 x 52 mm	120 mm	390 x 218 x 166h mm	218 x 275 mm	245 mm	18 mm	28 kg
M014/200	€ 359,00	200 x 63 mm	150 mm	440 x 239 x 183h mm	239 x 315 mm	275 mm	18 mm	40 kg

M024-**MORSA A MACCHINA CON BASE GIREVOLE 360°**

Con ganasce intercambiabili in acciaio temprate e rettificare. Parti di scorrimento rettificare. Vite scoperta. Con manovella e viti fissaggio

**M024/250**

Art.	€	Ganasce	Apertura	Dimensioni	Dimensioni base	Interasse fori	Cava	Peso netto
M024/136	€ 184,00	136 x 32 mm	170 mm	375 x 162 x 123h mm	223 x 165 mm	200 mm	14 mm	14 kg
M024/160	€ 265,00	160 x 50 mm	180 mm	402 x 182 x 142h mm	252 x 182 mm	225 mm	14 mm	23 kg
M024/200	€ 349,00	200 x 63 mm	220 mm	470 x 234 x 172h mm	290 x 222 mm	260 mm	18 mm	33 kg
M024/250	€ 507,00	250 x 45 mm	320 mm	612 x 280 x 186h mm	290 x 270 mm	245 mm	18 mm	50 kg

M530-**MORSA A MACCHINA INCLINABILE CON BASE GIREVOLE 360°**

Con ganasce intercambiabili in acciaio temprate e rettificare. Parti di scorrimento rettificare. Vite completamente coperta. Con manovella e viti fissaggio



Art.	€	Ganasce	Apertura	Inclinazione	Dimensioni	Dimensioni base	Interasse fori	Cava	Peso netto
M530/100	€ 318,00	100 x 32 mm	90 mm	0° - 90°	325 x 180 x 150h mm	250 x 180 mm	230 mm	14 mm	15 kg
M530/125	€ 378,00	125 x 40 mm	100 mm	0° - 90°	360 x 206 x 165h mm	290 x 226 mm	260 mm	18 mm	24 kg
M530/160	€ 463,00	160 x 50 mm	125 mm	0° - 90°	443 x 270 x 194h mm	300 x 255 mm	270 mm	28 mm	35 kg

M027-

PRO

MORSA TRAPANO

Dotata di guide raschiate per una maggiore precisione e un miglior scorrimento



Scatola



Ghisa



Trapano a colonna



Fresatrice

Art.	€	Ganasce	Apertura	Dimensioni base	Peso netto
M027/100	€ 158,00	100 x 40 mm	100 mm	290 x 170 mm	8 kg
M027/140	€ 222,00	140 x 50 mm	140 mm	375 x 230 mm	12 kg
M027/200	€ 360,00	200 x 60 mm	200 mm	485 x 295 mm	25 kg



M001-

MORSA TRAPANO

Dotata di una ganaschia prismatica ed una ganaschia liscia. Lunghezza complessiva costante grazie alla vite inserita nell'impugnatura



Scatola



Ghisa



Trapano a colonna

Art.	€	Ganasce	Apertura	Dimensioni base	Peso netto
M001/100	€ 59,40	100 mm	80 mm	182 x 156 mm	4 kg
M001/120	€ 72,90	120 mm	110 mm	210 x 175 mm	5 kg
M001/150	€ 91,40	150 mm	135 mm	245 x 195 mm	7 kg

0142-

MORSA TRAPANO

Dotata di una ganaschia prismatica ed una ganaschia liscia



Scatola



Ghisa



Trapano a colonna

Art.	€	Ganasce	Apertura	Dimensioni base	Peso netto
0142/75	€ 20,50	75 X 24 mm	55 mm	123 x 115 mm	1,5 kg
0142/100	€ 29,10	100 x 25,5 mm	85 mm	160 x 155 mm	2,5 kg
0142/125	€ 36,20	125 x 30 mm	100 mm	182 x 182 mm	4 kg

0698/100

€ 91,90

MORSA INCLINABILE

Ideale per forare con qualsiasi angolo di attacco



Scatola



Ghisa



Trapano a colonna

Ganasce	105 x 47 mm
Apertura	105 mm
Inclinazione	0°-15°-30°-45°-60°-75°-90°
Base	192 x 185 mm
Interasse fori	160 mm
Dimensioni	192 x 185 x 115h mm
Peso netto	8 kg

M034/120

€ 284,00

MORSA TRAPANO A SERRAGGIO RAPIDO

Con ganaschia prismatica e base girevole



Scatola



Ghisa



Trapano a colonna

Ganasce	120 x 40 mm
Apertura	120 mm
Dimensioni base	220 x 130 mm
Cava	14 mm
Peso netto	7 kg



0188-

MORSA A CROCE

Utile per eseguire lavorazioni di foratura o maschiatura di precisione grazie al movimento longitudinale e laterale senza rimuovere il pezzo dalla morsa

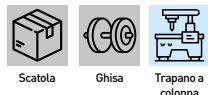

Art.	€	Ganasce	Apertura	Dimensioni base	Altezza	Corsa longitudinale	Corsa trasversale	Peso netto
0188/100	€ 86,30	100 x 25 mm	90 mm	240 x 140 mm	140 mm	130 mm	110 mm	7,5 kg
0188/125	€ 122,00	125 x 40 mm	110 mm	255 x 160 mm	150 mm	170 mm	130 mm	13 kg
0188/150	€ 154,00	150 x 40 mm	145 mm	280 x 170 mm	160 mm	160 mm	180 mm	14,5 kg

0188-xG

MORSA A CROCE CON GIREVOLE

Utile per eseguire lavorazioni di foratura o maschiatura di precisione grazie al movimento longitudinale e laterale senza rimuovere il pezzo dalla morsa. Dotata di base girevole



Art.	€	Ganasce	Apertura	Dimensioni base	Altezza	Corsa longitudinale	Corsa trasversale	Cava	Peso netto
0188/100G	€ 146,00	100 X 25 mm	90 mm	210 x 150 mm	175 mm	130 mm	110 mm	18mm	11,5 kg
0188/125G	€ 165,00	125 X 40 mm	120 mm	230 x 175 mm	180 mm	150 mm	120 mm	20mm	14,5 kg
0188/150G	€ 188,00	150 X 45 mm	150 mm	235 x 195 mm	190 mm	170 mm	115 mm	20mm	19,5 kg

P014

PRO € 318,00

SERIE PARALLELE

Rettificato a coppie. Utilizzati come spessori del pezzo in un'ampia varietà di operazioni di lavorazione, garantendo il bloccaggio parallelo



Dimensioni	150 x 10 x (14-16-18-20-22-24-26-28-30-32-35-40-45-50) mm
Durezza	HRC 60
Precisione	± 0,005 mm

P015

PRO € 173,00

SERIE PARALLELE

Rettificato a coppie. Utilizzati come spessori del pezzo in un'ampia varietà di operazioni di lavorazione, garantendo il bloccaggio parallelo



Dimensioni	160 x 4 x (10-14-18-22-26-30-34-38-42) mm
Durezza	HRC 60
Precisione	± 0,005 mm

P017

€ 122,00

SERIE PARALLELE

Rettificato a coppie. Utilizzati come spessori del pezzo in un'ampia varietà di operazioni di lavorazione, garantendo il bloccaggio parallelo



Dimensioni	150 x 8 x (14-16-20-24-30-32-36-40-44) mm
Durezza	HRC 45
Precisione	± 0,005 mm

D023 € 1850,00

DIVISORE RAPIDO A SCATTI ORIZZONTALE E VERTICALE

Permette di avere varie tipologie di divisioni in base al tipo di disco montato. La divisione viene effettuata automaticamente tramite la leva di avanzamento. Completo di staffe di bloccaggio

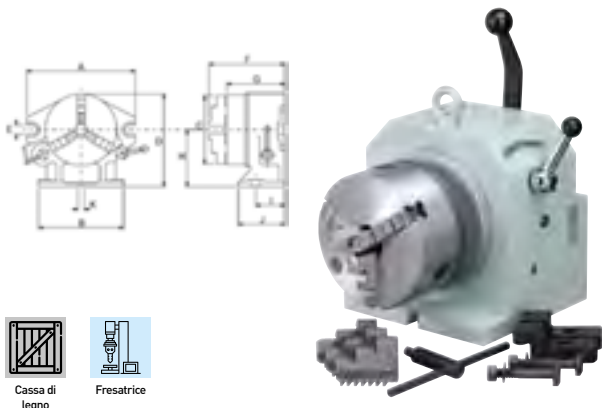

Divisioni	2 - 3 - 4 - 6 - 8 - 12 - 24
A	230 mm
B	230 mm
C	160 mm
D	236 mm
E	18 mm
F	320 mm
G	285 mm
H	125 mm
I	- mm
J	210 mm
K	18 mm
Foro	30 mm
Portata max orizzontale	50 kg
Portata max verticale	10 kg
Peso netto	66,5 kg

D003 € 1450,00

DIVISORE ORIZZONTALE VERTICALE A SCATTI RAPIDO

Permette di avere varie tipologie di divisioni in base al tipo di disco montato. La divisione viene effettuata automaticamente tramite la leva di avanzamento. Possibilità di divisione manuale di grado in grado 0° - 360°

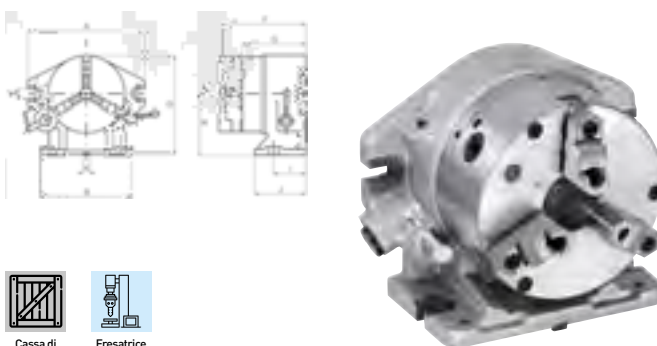

Divisioni	2 - 3 - 4 - 6 - 8 - 12 - 24
A	310 mm
B	255 mm
C	210 mm
D	259,25 mm
E	18 mm
F	214 mm
G	171,5 mm
H	149,25 mm
I	80 mm
J	130 mm
K	16 mm
Foro	62 mm
Portata max orizzontale	50 kg
Portata max verticale	10 kg
Peso netto	52 kg

T016/100 € 431,00

TAVOLA GIREVOLE BASCULANTE

Per posizionamenti precisi sia di rotazione che di inclinazione grazie alla graduazioni presenti sul volantino e leva bloccaggio inclinazione. Completo di staffe di bloccaggio

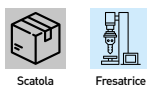

A	143 mm
B	130 mm
C	105 mm
D	102 mm
d	18 mm
H	68 mm
Rotazione	360°
Inclinazione tavola	90°
Rapporto	1:36
Cave	4 x 6.35 mm 5/16"
Altezza in orizzontale	102 mm
Peso netto	5 kg

T017/100 € 616,00

TAVOLA GIREVOLE BASCULANTE CON MANDRINO

Per posizionamenti precisi sia di rotazione che di inclinazione grazie alla graduazioni presenti sul volantino e leva bloccaggio inclinazione. Completo di staffe di bloccaggio

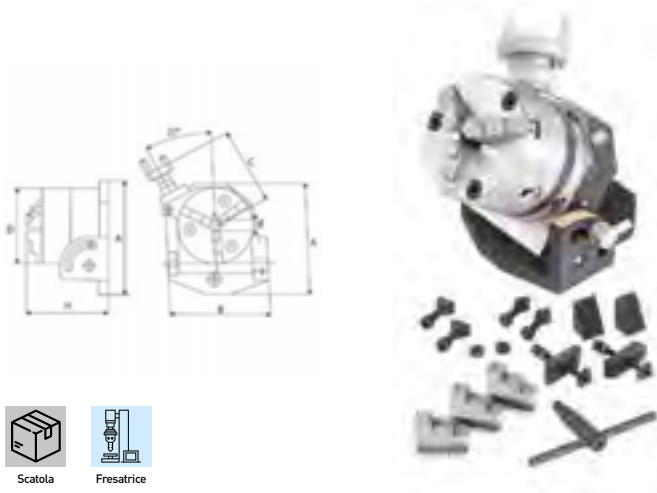

Mandrino	100 mm
A	143 mm
B	130 mm
C	105 mm
D	100 mm
d	20 mm
H	160 mm
Rotazione	360°
Inclinazione tavola	90°
Rapporto	1:36
Cave	4 x 8 mm
Altezza in orizzontale	102 mm
Peso netto	11 kg



T001-

TAVOLO A DIVIDERE BASCULANTE 0° ÷ 90°

Dotata di regolazione micrometrica ed ingranaggi a bagno d'olio



Cassa di legno



Fresatrice

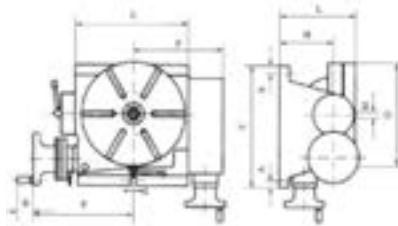

Art.	€	A	B	C	D	E	F	G	H	L	CM	Rapporto	Cave	Portata max orizzontale	Portata max verticale	Peso netto
T001/250	€ 2480,00	14 mm	40 mm	310 mm	250 mm	252 mm	199 mm	14 mm	140 mm	205 mm	3	1:90	6/12 N° / mm	200 kg	100 kg	78 kg
T001/320	€ 2720,00	16 mm	40 mm	380 mm	320 mm	322 mm	241 mm	18 mm	185 mm	257 mm	4	1:90	6/14 N° / mm	250 kg	125 kg	133 kg

D005-

DISCHI DIVISORI PER TAVOLA A DIVIDERE



Scatola



Art.	€	Per tavole	Rapporto	Fori nei dischi	Foro	Esterno
D005	€ 223,00	T001/250 - 320, T002/160 - 320	1:90	A: 34-37-38-39-41-43-44-50-52-56-6, B: 46-47-49-51-53-54-57-58-59-62-64	38 mm	130 mm
D005/100	€ 223,00	T002/100	1:72	A:10	29 mm	90 mm
D005/400	€ 250,00	T002/400	1:90	A: 34-37-38-39-41-43-44-50-52-56-61, B: 46-47-49-51-53-54-57-58-59-62-64	53 mm	170 mm
D005/500	€ 331,00	T012/500 T012/630	1:120	A: 33-34-37-38-39-41-43-44-50-52-56-61, B: 46-47-49-51-53-54-57-58-59-62-63-64	53 mm	170 mm

T002-

TAVOLO A DIVIDERE ORIZZONTALE VERTICALE

Dotata di regolazione micrometrica ed ingranaggi a bagno d'olio

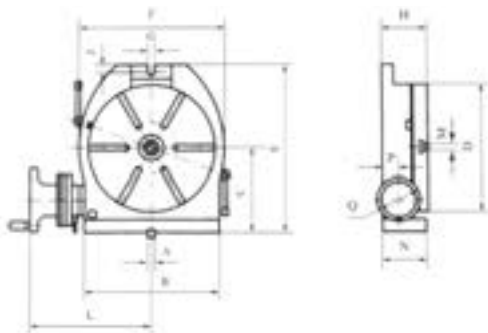

Cassa di legno



Fresatrice

Art.	€	A	B	C	D	E	F	G	H	J	L	N	P	Q	CM	Rapporto	Cave	Portata max orizzontale	Portata max verticale	Peso netto
T002/100	€ 611,00	10 mm	125 mm	70 mm	100 mm	125 mm	125 mm	/	70 mm	0 mm	104 mm	48 mm	30 mm	50 mm	2	1:72	4/6 N° / mm	20 kg	10 kg	7 kg
T002/160	€ 769,00	12 mm	186 mm	125 mm	160 mm	242 mm	196 mm	12 mm	85 mm	12 mm	194 mm	82 mm	37 mm	125 mm	2	1:90	4/10 N° / mm	100 kg	50 kg	23 kg
T002/200	€ 897,00	14 mm	208 mm	150 mm	200 mm	285 mm	236 mm	14 mm	100 mm	15 mm	211 mm	99 mm	48 mm	125 mm	3	1:90	4/12 N° / mm	150 kg	75 kg	30 kg
T002/250	€ 949,00	14 mm	253 mm	170 mm	250 mm	328 mm	286 mm	14 mm	110 mm	16 mm	241 mm	106 mm	48 mm	125 mm	4	1:90	6/12 N° / mm	200 kg	100 kg	44 kg
T002/320	€ 1530,00	18 mm	321 mm	210 mm	320 mm	410 mm	360 mm	18 mm	120 mm	16 mm	273 mm	118 mm	48 mm	125 mm	4	1:90	6/14 N° / mm	250 kg	125 kg	75 kg
T002/400	€ 2130,00	18 mm	400 mm	260 mm	400 mm	525 mm	450 mm	18 mm	150 mm	16 mm	337 mm	145 mm	70 mm	160 mm	4	1:90	6/14 N° / mm	300 kg	150 kg	174 kg

C054 € 227,00
CONTROPUNTA REGOLABILE IN ALTEZZA



Per tavole	T002/160
Altezza punta	95 - 150 mm
Peso netto	9 kg

C051 € 299,00
CONTROPUNTA REGOLABILE IN ALTEZZA



Per tavole	T001/250 - T002/200 - T002/250
CM	2
Altezza punta	140 - 180 mm
Peso netto	18 kg

C052 € 387,00
CONTROPUNTA REGOLABILE IN ALTEZZA



Per tavole	T002/320 - T001/320
CM	2
Altezza punta	180 - 224 mm
Peso netto	20 kg

D004-

DIVISORE UNIVERSALE COMPLETO DI MANDRINO, CONTROPUNTA E DISCHI DIVISORI

Consente all'operatore di eseguire rotazioni angolari esattamente determinate, quali sono ad esempio richieste per le divisioni di una circonferenza in un certo numero di parti uguali.

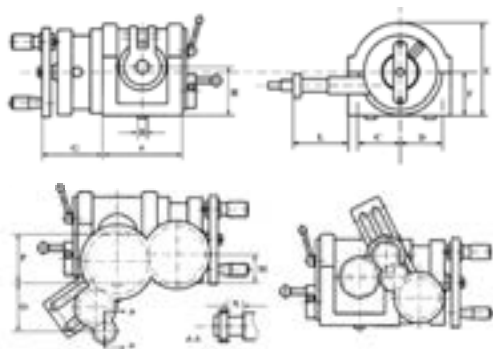

Art.	€	A	B	C	D	E	F	G	H	L	CM	N	P	Mandrino	Rapporto	Portata	Fori nei dischi	Peso netto
D004/100L	€ 2410,00	162 mm	14 mm	102 mm	87 mm	186 mm	95 mm	116 mm	100 mm	93 mm	3	30 mm	100 mm	Ø 125 mm	1:40	100 kg	24-25-28-30-34-37-38-39-41-42-43-46-47-49-51-53-54-57-58-59-62-66	67 kg
D004/125L	€ 2700,00	209 mm	18 mm	116 mm	98 mm	224 mm	117 mm	120 mm	125 mm	103 mm	4	34,5 mm	100 mm	Ø 160 mm	1:40	130 kg	24-25-28-30-34-37-38-39-41-42-43-46-47-49-51-53-54-57-58-59-62-66	119 kg
D004/160L	€ 3020,00	209 mm	18 mm	116 mm	98 mm	259 mm	152 mm	120 mm	160 mm	103 mm	4	34,5 mm	100 mm	Ø 200 mm	1:40	130 kg	24-25-28-30-34-37-38-39-41-42-43-46-47-49-51-53-54-57-58-59-62-66	125 kg

D006-

DIVISORE SEMI UNIVERSALE COMPLETO DI CONTROPUNTA E DISCHI DIVISORI

Mandrino non incluso, dotato di vite senza fine temprata e rettificata e di cuscinetti a rulli conici di precisione. consente all'operatore di eseguire rotazioni angolari esattamente determinate, quali sono ad esempio richieste per le divisioni di una circonferenza in un certo numero di parti uguali

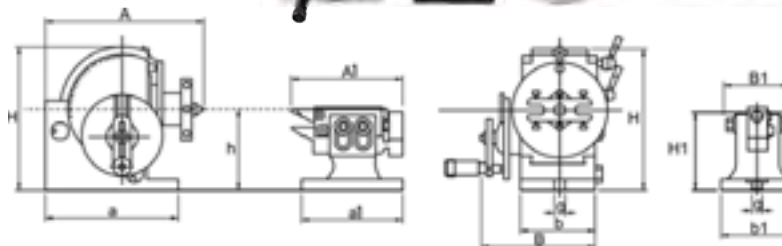

Art.	€	A	B	H	h	a	b	G	A1	B1	H1	h1	a1	b1	Mandrino adattabile	g1	Foro	CM	Rapporto	Inclinazione testa	Fori nei dischi	Peso netto
D006/100	€ 833,00	131 mm	173 mm	100 mm	166 mm	90 mm	16 mm	175 mm	87 mm	102 mm	100 mm	130 mm	82 mm	Ø 125 mm	16 mm	Ø 18 mm	2	1:40	-10° - 90°	15-16-17-18-19-20-21-23-27-29-31-33-37-39-41-43-47-49	16 kg	
D006/128	€ 1360,00	168 mm	220 mm	128 mm	206 mm	113 mm	16 mm	183 mm	87 mm	137 mm	128 mm	158 mm	110 mm	Ø 160 mm	16 mm	Ø 20 mm	3	1:40	-10° - 90°	15-16-17-18-19-20-21-23-27-29-31-33-37-39-41-43-47-49	30 kg	

**T013**

€ 1200,00

TAVOLA A CROCE

Con canaline per refrigerante. Graduazione registrabile del volantino



Cassa di legno



Ghisa



Fresatrice

A	210 mm
B	730 mm
C	315 mm
D	395 mm
E	240 mm
F	300 mm
Cava	14 mm
Altezza	155 mm
Spostamenti	160 x 360 mm
Divisione	0,05 mm
Peso netto	70 kg

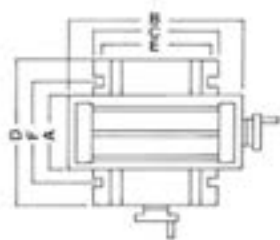
**T014G**

€ 1020,00

TAVOLA A CROCE GIREVOLE

Dotata di base girevole. Con canaline per refrigerante. Graduazione registrabile del volantino



Cassa di legno



Ghisa



Fresatrice

A	240 mm
B	600 mm
C	280 mm
D	340 mm
E	260 mm
F	250 mm
Cava	12 mm
Altezza	160 mm
Spostamenti	155 x 370 mm
Divisione	0,02 mm
Peso netto	60 kg

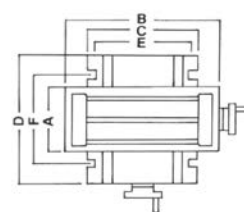
**T015****PRO** € 538,00**TAVOLA A CROCE**

Con graduazione registrabile del volantino. Dotata di lardone conico con vite in testa e guide raschiate per una maggiore precisione e un miglior scorrimento



Scatola



Ghisa



Fresatrice

A	100 mm
B	185 mm
C	130 mm
D	170 mm
E	104 mm
F	103 mm
Cava	10 mm
Altezza	100 mm
Spostamenti	50 x 80 mm
Divisione	0,01 mm
Peso netto	10 kg

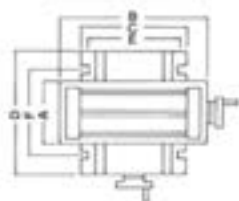
**T015/E**

€ 286,00

TAVOLA A CROCE

Con Graduazione registrabile del volantino



Scatola



Ghisa



Fresatrice

A	100 mm
b	185 mm
C	130 mm
D	173 mm
E	102 mm
F	100 mm
Cava	10 mm
Altezza	104 mm
Spostamenti	50 x 80 mm
Divisione	0,01 mm
Peso netto	10 kg

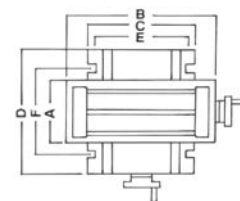

T008

€ 333,00

TAVOLA A CROCE



A	153 mm
B	475 mm
C	200 mm
D	270 mm
Cava	16 mm
Interasse cava	75 mm
Altezza	130 mm
Spostamenti	120 x 325 mm
Interasse fori base	162 mm
Peso netto	23 kg

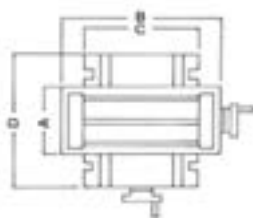

T018/350

€ 158,00

TAVOLA A CROCE

Con scala millimetrata fissa per i movimenti della tavola longitudinali



A	100 mm
B	350 mm
C	160 mm
D	190 mm
Altezza	120 mm
Cava	8 mm
Interasse cava	36 mm
Spostamenti	177 x 50 mm
Divisione	0.05 mm
Dimensioni ingombro	415 x 255 mm
Peso netto	6 kg

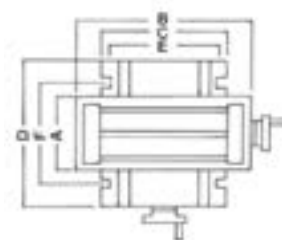

T018/330

€ 84,20

TAVOLA A CROCE

Con scala millimetrata fissa per i movimenti della tavola longitudinali



A	95 mm
B	330 mm
C	125 mm
D	145 mm
Altezza	82 mm
Cava	8 mm
Interasse cava	36 mm
Spostamenti	190 x 65 mm
Divisione	0,05 mm
Dimensioni ingombro	395 x 210 mm
Peso netto	2,5 kg

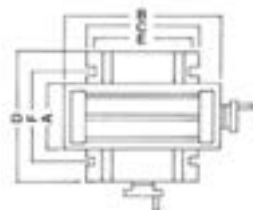

T004-

TAVOLA BASCULANTE

Con regolazione dell'inclinazione su entrambi i lati

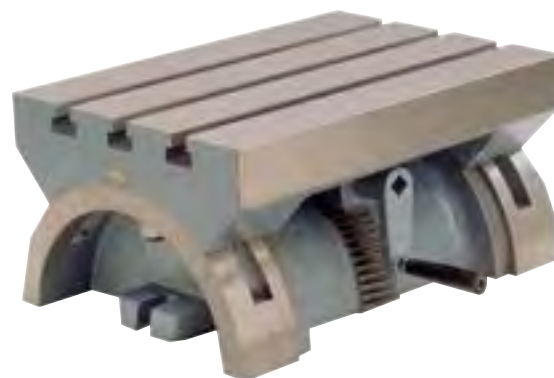

Art.	€	Dimensioni	Cava	Inclinazione	Peso netto
T004/250	€ 392,00	255 x 180 x 135h mm	12 mm	± 36°	15 kg
T004/380	€ 595,00	380 x 250 x 180h mm	16 mm	± 36°	45 kg
T004/600	€ 1010,00	610 x 305 x 253h mm	16 mm	± 36°	105 kg

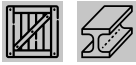
**P077-****NEW****PIANO MAGNETICO PERMANENTE**Cassa di legno
Acciaio

Art.	€	Dimensioni	Forza magnetica	Passo polarità	Peso netto
P077/1525	€ 693,00	250 x 150 x 60 mm	180 N/cm ²	3 + 12 mm	17 Kg
P077/1530	€ 825,00	300 x 150 x 60 mm	180 N/cm ²	3 + 12 mm	20 Kg
P077/2040	€ 1460,00	400 x 200 x 60 mm	180 N/cm ²	3 + 12 mm	37 Kg
P077/3050	€ 2750,00	500 x 300 x 60 mm	180 N/cm ²	3 + 12 mm	65 Kg
P077/3060	€ 3300,00	600 x 300 x 60 mm	180 N/cm ²	3 + 12 mm	80 Kg

**P078-****NEW****PIANO MAGNETICO PERMANENTE**

Con polarità fitta, permette la lavorazione di pezzi di piccole dimensioni e di basso spessore grazie al passo fine.

Cassa di legno
Acciaio

Art.	€	Dimensioni	Forza magnetica	Passo polarità	Peso netto
P078/1525	€ 451,00	250 x 150 x 48 mm	120 N/cm ²	0,5 + 1,5 mm	16 Kg
P078/1530	€ 534,00	300 x 150 x 48 mm	120 N/cm ²	0,5 + 1,5 mm	17 Kg
P078/1535	€ 600,00	350 x 150 x 48 mm	120 N/cm ²	0,5 + 1,5 mm	20 Kg
P078/1540	€ 671,00	400 x 150 x 51 mm	120 N/cm ²	0,5 + 1,5 mm	24 Kg
P078/1545	€ 781,00	450 x 150 x 51 mm	120 N/cm ²	0,5 + 1,5 mm	27 Kg
P078/2045	€ 1100,00	450 x 200 x 51 mm	120 N/cm ²	0,5 + 1,5 mm	38 Kg
P078/2050	€ 1210,00	500 x 200 x 58 mm	120 N/cm ²	0,5 + 1,5 mm	57 Kg
P078/2060	€ 1430,00	600 x 200 x 58 mm	120 N/cm ²	0,5 + 1,5 mm	55 Kg

**P079-****NEW****PIANO MAGNETICO CON BARRA SENO**Scatola
Acciaio

Art.	€	Dimensioni	Passo polarità	Inclinazione	Peso netto
P079/1515	€ 880,00	150 x 150 x 86 mm	0,5 + 1,5 mm	0° - 60°	17 Kg
P079/1530	€ 1210,00	150 x 300 x 86 mm	0,5 + 1,5 mm	0° - 60°	32 Kg

**K001-****KIT STAFFAGGIO**

Composte da: 24 tiranti, 6 dadi a T, 6 dadi bassi, 4 manicotti giunzione, 6 staffe semplici, 12 appoggi gradinati, pratico supporto da parete

58 Pcs
Scatola
Acciaio

Art.	€	Cava	Filetto
K001/12	€ 114,00	12 mm	M10
K001/14	€ 127,00	14 mm	M12
K001/16	€ 148,00	16 mm	M14
K001/18	€ 185,00	18 mm	M16

**k002-****SET STAFFAGGIO**

Composto da 2 appoggi gradinati, 2 tiranti e 2 bulloni con testa a T e dadi flangiati. Per fissare gli elementi da fresare su tavole

6 Pcs
Appendibile
Acciaio
Zincata

Art.	€	2 Cunei di blocco	2 Staffe	2 Tiranti a T con dado	Cava
K002/08	€ 30,70	25 x 25 x 42 mm	90 x 25 x 12 mm	M6 x 100 mm	8 mm
K002/10	€ 32,80	25 x 25 x 42 mm	100 x 25 x 15 mm	M8 x 100 mm	10 mm
K002/12	€ 36,00	25 x 25 x 42 mm	100 x 25 x 15 mm	M10 x 100 mm	12 mm
K002/14	€ 42,30	25 x 25 x 42 mm	100 x 31 x 19 mm	M12 x 100 mm	14 mm



FD0x-

FLANGIA CON PERNI

Camlock DIN 55029 a cono corto con lato mandrino grezzo



Art.	€	Cam lock Tipo	Misura	Spessore	Perni
FD04/200	€ 196,00	4"	Ø 200 mm	28 mm	Ø 15,9 mm
FD05/200	€ 196,00	5"	Ø 200 mm	30 mm	Ø 19 mm
FD05/250	€ 269,00	5"	Ø 250 mm	30 mm	Ø 19 mm
FD06/250	€ 275,00	6"	Ø 250 mm	30 mm	Ø 22 mm
FD06/380	€ 366,00	6"	Ø 400 mm	30 mm	Ø 22 mm
FD08/250	€ 278,00	8"	Ø 250 mm	30 mm	Ø 25,4 mm
FD08/320	€ 319,00	8"	Ø 320 mm	30 mm	Ø 25,4 mm
FD08/380	€ 486,00	8"	Ø 400 mm	30 mm	Ø 25,4 mm
FD08/500	€ 559,00	8"	Ø 500 mm	36 mm	Ø 25,4 mm
FD11/320	€ 338,00	11"	Ø 320 mm	30 mm	Ø 30,0 mm
FD11/400	€ 465,00	11"	Ø 400 mm	30 mm	Ø 30,0 mm
FD11/500	€ 595,00	11"	Ø 500 mm	36 mm	Ø 30 mm



M049-

MANDRINO AUTOCENTRANTE DI PRECISIONE

A guida singola. griffe integrali, serraggio concentrico, dotato di 1 serie composta da 3 griffe per interni, 1 serie composta da 3 griffe per esterni e chiave di serraggio

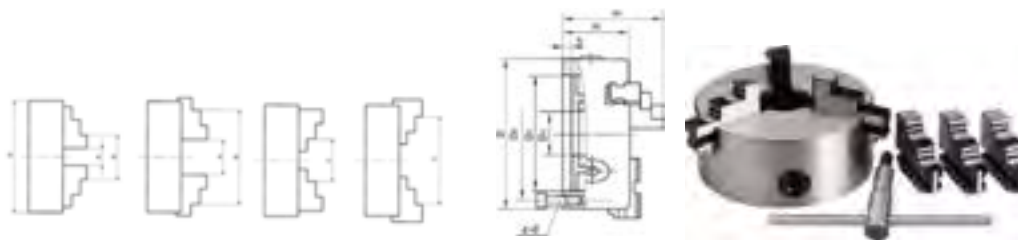

Art.	€	D1	D2	D3	H1	H	h	z-d	Quadro chiave	A - A1	B - B1	C - C1	Peso netto
M049/080	€ 170,00	55 mm	66 mm	16 mm	66 mm	50 mm	3,5 mm	3-M6 mm	8 mm	2 - 22 mm	25 - 70 mm	22 - 63 mm	1,6 kg
M049/100	€ 190,00	72 mm	84 mm	22 mm	74,5 mm	55 mm	3,5 mm	3-M8 mm	8 mm	2 - 30 mm	30 - 90 mm	30 - 80 mm	3 kg
M049/125	€ 201,00	95 mm	108 mm	30 mm	78 mm	55 mm	3,5 mm	3-M8 mm	10 mm	2,5 - 40 mm	38 - 125 mm	38 - 110 mm	4,8 kg
M049/160	€ 265,00	130 mm	142 mm	40 mm	95 mm	65 mm	5 mm	3-M8 mm	12 mm	3 - 55 mm	50 - 160 mm	55 - 145 mm	8,5 kg
M049/200	€ 366,00	165 mm	180 mm	60 mm	109 mm	75 mm	6 mm	3-M10 mm	12 mm	4 - 85 mm	65 - 200 mm	65 - 200 mm	14,5 kg
M049/250	€ 426,00	206 mm	226 mm	80 mm	120 mm	80 mm	5 mm	3-M12 mm	12 mm	6 - 110 mm	80 - 250 mm	90 - 250 mm	24 kg
M049/320	€ 754,00	270 mm	290 mm	100 mm	142 mm	90 mm	11 mm	3-M16 mm	13 mm	10 - 140 mm	95 - 320 mm	100 - 320 mm	45 kg
M049/400	€ 1170,00	340 mm	368 mm	130 mm	158 mm	100 mm	8 mm	3-M16 mm	15 mm	15 - 210 mm	120 - 400 mm	120 - 400 mm	72 kg

M449-

MANDRINO AUTOCENTRANTE

A guida singola. griffe integrali, serraggio concentrico, dotato di 1 serie composta da 4 griffe per interni, 1 serie composta da 4 griffe per esterni e chiave di serraggio

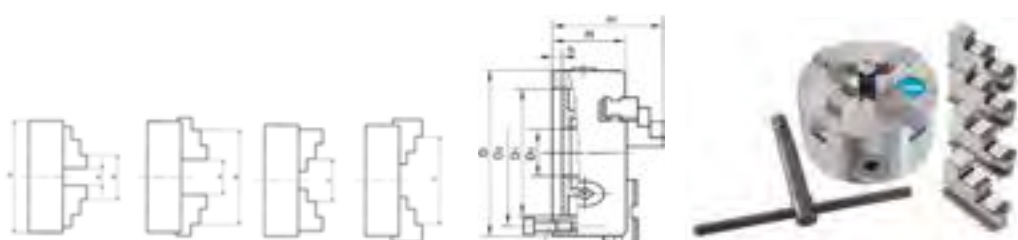

Art.	€	D	D1	D2	D3	H1	H	h	z-d	Quadro chiave	A - A1	B - B1	C - C1	Peso netto
M449/080	€ 178,00	80 mm	55 mm	66 mm	16 mm	66 mm	50 mm	3,5 mm	3 - M6 mm	8 mm	2 - 22 mm	25 - 70 mm	22 - 63 mm	1,8 kg
M449/100	€ 201,00	100 mm	72 mm	84 mm	22 mm	74,5 mm	55 mm	4,5 mm	3 - M8 mm	8 mm	2 - 30 mm	30 - 90 mm	30 - 80 mm	3 kg
M449/125	€ 232,00	125 mm	95 mm	108 mm	30 mm	84 mm	58 mm	4 mm	3 - M8 mm	10 mm	2,5 - 40 mm	38 - 125 mm	38 - 110 mm	5 kg
M449/160	€ 292,00	160 mm	130 mm	142 mm	40 mm	95 mm	65 mm	5 mm	3 - M8 mm	10 mm	3 - 55 mm	50 - 160 mm	55 - 145 mm	8,5 kg
M449/200	€ 413,00	200 mm	165 mm	187 mm	65 mm	109 mm	75 mm	5 mm	3 - M10 mm	12 mm	4 - 85 mm	65 - 200 mm	65 - 200 mm	15 kg
M449/250	€ 534,00	250 mm	206 mm	226 mm	80 mm	120 mm	80 mm	5 mm	3 - M12 mm	12 mm	6 - 110 mm	80 - 250 mm	90 - 250 mm	24 kg
M449/320	€ 918,00	320 mm	270 mm	290 mm	100 mm	142 mm	90 mm	6 mm	3-M16 mm	14 mm	10 - 140 mm	95 - 320 mm	100 - 320 mm	45 kg
M449/400	€ 1420,00	400 mm	340 mm	368 mm	130 mm	158 mm	100 mm	6 mm	3-M16 mm	17 mm	15 - 210 mm	120 - 400 mm	120 - 400 mm	74 kg

M005-

MANDRINO AUTOCENTRANTE DI PRECISIONE

A Guida singola, dotato di 3 morsetti con base in acciaio temperato e griffe reversibili interni - esterni tenere, chiave di serraggio e viti fissaggio griffe

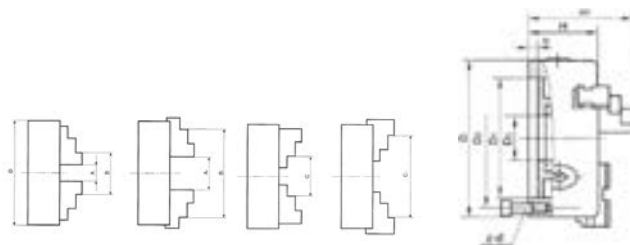

Art.	€	D1	D2	D3	H1	H	h	z-d	Quadro chiave	A - A1	B - B1	C - C1	Peso netto
M005/200	€ 366,00	165 mm	180 mm	65 mm	122 mm	75 mm	5 mm	3-M10 mm	12 mm	4 - 85 mm	65 - 200 mm	65 - 200 mm	12 kg
M005/250	€ 426,00	206 mm	226 mm	80 mm	135 mm	80 mm	5 mm	3-M12 mm	12 mm	6 - 110 mm	80 - 250 mm	90 - 250 mm	20 kg
M005/320	€ 672,00	270 mm	290 mm	100 mm	135 mm	90 mm	6 mm	3-M16 mm	14 mm	10 - 140 mm	95 - 320 mm	100 - 320 mm	42 kg
M005/400	€ 1080,00	340 mm	368 mm	130 mm	172 mm	100 mm	8 mm	3-M16 mm	17 mm	15 - 210 mm	120 - 400 mm	120 - 400 mm	68 kg
M005/500	€ 1840,00	440 mm	465 mm	200 mm	202 mm	115 mm	6 mm	6-M16 mm	17 mm	25 - 280 mm	150 - 500 mm	150 - 500 mm	110 kg
M005/630	€ 5200,00	560 mm	595 mm	260 mm	218 mm	130 mm	7 mm	6-M16 mm	19 mm	50 - 350 mm	170 - 630 mm	170 - 630 mm	200 kg

P444-

PIATTAFORMA A 4 GRIFFE INDIPENDENTI

Con comando a vite, attacco a flangia, griffe a guida semplice reversibili per presa interna ed esterna. Dotato di chiave per griffe e viti di fissaggio

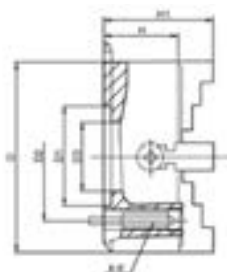

Art.	€	D	D1	D2	D3	H1	H	h	z-d	Quadro chiave	Peso netto
P444/160	€ 229,00	160 mm	65 mm	95 mm	45 mm	97 mm	67 mm	4 mm	4 - M10 mm	10 mm	8 kg
P444/200	€ 299,00	200 mm	75 mm	95 mm	56 mm	107 mm	75 mm	6 mm	4 - M10 mm	10 mm	14 kg
P444/250	€ 399,00	250 mm	110 mm	130 mm	75 mm	120 mm	80 mm	6 mm	4 - M12 mm	12 mm	21,5 kg
P444/320	€ 640,00	320 mm	140 mm	165 mm	95 mm	134 mm	90 mm	6 mm	4 - M16 mm	14 mm	40 kg
P444/400	€ 838,00	400 mm	160 mm	185 mm	125 mm	141 mm	95 mm	8 mm	4 - M16 mm	14 mm	63 kg

M049-xST

SERIE 3 GRIFFE TENERE INTEGRALI

Per mandrini autocentranti a guida semplice



Art.	€	Diametro
M049/125ST	€ 91,80	Ø 125 mm
M049/160ST	€ 102,00	Ø 160 mm

M049-xGBD

SERIE 3 GRIFFE TENERE CON BASI DURE

Con base in acciaio temprato, per mandrino autocentrante a guida semplice



Art.	€	Diametro
M049/200GBD	€ 178,00	Ø 200 mm
M049/250GBD	€ 235,00	Ø 250 mm
M049/320GBD	€ 329,00	Ø 320 mm
M049/400GBD	€ 423,00	Ø 400 mm

M449-xST

SERIE 4 GRIFFE TENERE INTEGRALI

Per mandrini autocentranti a guida semplice



Acciaio



Art.	€	Diametro
M449/125ST	€ 113,00	Ø 125 mm
M449/160ST	€ 132,00	Ø 160 mm

M449-xGBD

SERIE 4 GRIFFE TENERE CON BASI DURE

Con base in acciaio temprato, per mandrino autocentrante a guida semplice



Acciaio



Art.	€	Diametro
M449/200GBD	€ 265,00	Ø 200 mm
M449/250GBD	€ 351,00	Ø 250 mm
M449/320GBD	€ 520,00	Ø 320 mm
M449/400GBD	€ 662,00	Ø 400 mm

2622x

MORSETTO TENERO PER MANDRINI

Applicabile su griffe dure



Acciaio



Art.	€	Ø	Interasse fori
M075/160T	€ 24,90	160 mm	38,1 mm
M075/200T	€ 27,50	200 mm	44,50 mm
M075/250T	€ 29,70	250 mm	54 mm
M075/315T	€ 37,20	315 mm	63,5 mm
262206R	€ 75,60	400 mm	76,2 mm
262207R	€ 105,00	500 - 630 mm	76,2 mm

0563-

NEW

CHIAVE PER MANDRINO

Per mandrini, con molla di sicurezza



Acciaio



Brunita



Tornio



Art.	€	Quadro chiave	Dimensioni
0563/08	€ 11,90	8 mm	61 x 120 mm
0563/10	€ 15,10	10 mm	120 x 210 mm
0563/12	€ 17,80	12 mm	155 x 300 mm
0563/13	€ 20,10	13 mm	120 x 300 mm
0563/14	€ 23,30	14 mm	130 x 350 mm
0563/17	€ 26,50	17 mm	130 x 400 mm
0563/19	€ 29,70	19 mm	200 x 500 mm

0425-

MANDRINO AUTOCENTRANTE A 4 GRIFFE

Per tornio da legno, Ø 125mm.



Scatola

Acciaio



Art.	€	Ø	Capacità di serraggio	Filetto
0425/100	€ 191,00	95 mm	Int. 32 - 45 mm - Ext. 68 - 85 mm	1" - 8 TPI
0425/125	€ 217,00	125 mm	Int. 50 - 70 mm - Ext. 85 - 110 mm	1" - 8 TPI e M33 x 3,5

0751/A4

€ 122,00

MANDRINO PER TORNIO



Scatola

Acciaio



Autocentrante 4 griffe reversibili	Ø 125 mm
Filetto	1" - 8 TPI
Foro	Ø 22 mm

0751/P

€ 65,30

MANDRINO PER TORNIO



Scatola

Acciaio



4 griffe reversibili indipendenti	Ø 150 mm
Filetto	1" - 8 TPI
Foro	Ø 22 mm

M051-

PRO

MANDRINO AUTOSERRANTE DI PRECISIONE

Per uso industriale, anche nelle più severe condizioni di utilizzo. Parti di scorrimento interamente temprate e rettifiche. Durezza griffe mandrino HRC58

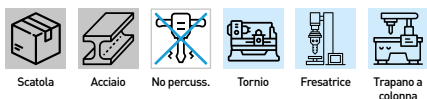

Art.	€	Capacità	Attacco DIN	Dimensioni
M051/08	€ 55,40	0,5 ÷ 8 mm	B 12	Ø 39 x 80 mm
M051/10	€ 55,40	1 ÷ 10 mm	B 12	Ø 44.5 x 82 mm
M051/13	€ 65,10	1 ÷ 13 mm	B 16	Ø 49.5 x 91 mm
M051/16	€ 78,50	1 ÷ 16 mm	B 18	Ø 54 x 102.5 mm
M051/20	€ 101,00	1 ÷ 20 mm	B 22	Ø 59 x 119 mm



M042-

NEW

MANDRINO AUTOSERRANTE PROFESSIONALE

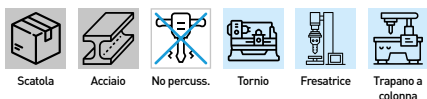

Art.	€	Capacità	Attacco DIN
M042/08	€ 46,60	0.5 ÷ 8 mm	B12
M042/10	€ 47,70	1 ÷ 10 mm	B12
M042/13	€ 54,60	1 ÷ 13 mm	B16
M042/16	€ 65,70	3 ÷ 16 mm	B18
M042/20	€ 87,50	5 ÷ 20 mm	B22



M052-

NEW

MANDRINO CON SERRAGGIO A CREMAGLIERA



Art.	€	Capacità	Attacco DIN	Dimensioni
M052/10	€ 14,70	1 ÷ 10 mm	B12	Ø 39 x 80 mm
M052/13	€ 19,30	1 ÷ 13 mm	B16	Ø 41.5 x 95.4 mm
M052/16	€ 23,10	3 ÷ 16 mm	B 18	Ø 49 x 108.2 mm
M052/20	€ 35,00	5 ÷ 20 mm	B22	Ø 54 x 114.1 mm



0711-

NEW

CHIAVE SERRAGGIO MANDRINO A CREMAGLIERA

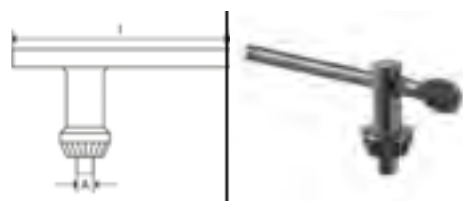

Art.	€	l	A
0711/06	€ 1,38	56 mm	5 mm
0711/10	€ 1,59	56 mm	5 mm
0711/13	€ 1,96	80 mm	6 mm
0711/16	€ 2,33	90 mm	7 mm
0711/20	€ 3,71	120 mm	8 mm

M050/13

€ 15,60

MANDRINO AUTOSERRANTE

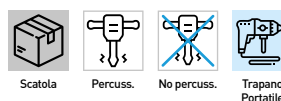

Capacità	2 ÷ 13 mm
Attacco	1/2 20 UNF



M080-

MANDRINO AUTOSERRANTE CON GHIERA DI BLOCCAGGIO

Per l'utilizzo a doppia rotazione e percussione. Chiusura rapida senza chiave con bloccaggio radiale, mediante rotazione del corpo mandrino. Corpo rivestito in materiale sintetico e parti operanti in acciaio. con vite di fissaggio sinistra

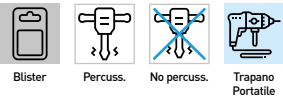

Art.	€	Capacità	Attacco
M080/10	€ 17,60	0,8 ÷ 10 mm	3/8 24 UNF
M080/13	€ 19,00	2 ÷ 13 mm	1/2 20 UNF

1-xA

MANDRINO PORTA PUNTE

DIN 69871/A, corpo mandrino bilanciato, con asola di estrazione per utensili

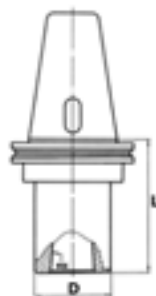

Art.	€	ISO	CM	D	L	Equilibratura rpm
1/1A40	€ 95,30	40	1	25 mm	45 mm	12000
1/2A40	€ 95,30	40	2	32 mm	60 mm	12000
1/3A40	€ 95,30	40	3	40 mm	75 mm	12000
1/4A40	€ 95,30	40	4	50 mm	98 mm	12000
1/2A50	€ 192,00	50	2	32 mm	40 mm	12000
1/3A50	€ 192,00	50	3	40 mm	50 mm	12000
1/4A50	€ 192,00	50	4	48 mm	95 mm	12000
1/5A50	€ 192,00	50	5	63 mm	110 mm	12000

NEW

M081-

MANDRINO CON SERRAGGIO A CREMAGLIERA

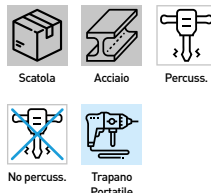

Art.	€	Capacità	Attacco
M081/13	€ 10,10	1÷13mm	1/2" 20 UNF
M081/13A	€ 10,10	1÷13mm	3/8" 24 UNF

1-xD

MANDRINO PORTA PUNTE

MAS-403 BT, corpo mandrino bilanciato, con asola di estrazione per utensili

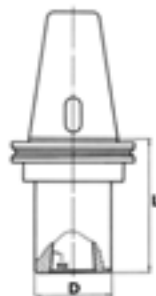

Art.	€	BT	CM	D	L	Equilibratura rpm
1/1D40	€ 136,00	40	1	25 mm	45 mm	12000
1/2D40	€ 136,00	40	2	32 mm	60 mm	12000
1/3D40	€ 136,00	40	3	40 mm	75 mm	12000
1/4D40	€ 136,00	40	4	50 mm	98 mm	12000
1/2D50	€ 140,00	50	2	32 mm	40 mm	12000
1/3D50	€ 140,00	50	3	40 mm	75 mm	12000
1/4D50	€ 156,00	50	4	50 mm	80 mm	12000
1/5D50	€ 184,00	50	5	63 mm	110 mm	12000

ST45-xL

RIDUZIONE PROLUNGATA CONO MORSE

Per il montaggio di utensili con gambo conico morse DIN 2187

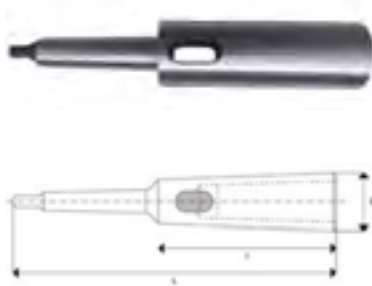

Art.	€	CM Esterno	CM Interno	L	l	D
ST45/2/1L	€ 17,80	2	1	160 mm	85 mm	20 mm
ST45/2/2L	€ 21,70	2	2	175 mm	90 mm	30 mm
ST45/2/3L	€ 24,70	2	3	196 mm	121 mm	36 mm
ST45/3/1L	€ 23,30	3	1	175 mm	81 mm	20 mm
ST45/3/2L	€ 24,70	3	2	194 mm	100 mm	30 mm
ST45/3/3L	€ 34,70	3	3	215 mm	121 mm	36 mm
ST45/3/4L	€ 44,50	3	4	240 mm	146 mm	48 mm
ST45/4/1L	€ 36,10	4	1	200 mm	82,5 mm	20 mm
ST45/4/2L	€ 37,20	4	2	215 mm	97,5 mm	30 mm
ST45/4/3L	€ 45,00	4	3	240 mm	122,5 mm	36 mm
ST45/4/4L	€ 50,00	4	4	265 mm	147,5 mm	48 mm
ST45/4/5L	€ 71,70	4	5	300 mm	182,5 mm	63 mm
ST45/5/1L	€ 58,40	5	1	232 mm	82,5 mm	20 mm
ST45/5/2L	€ 59,40	5	2	247 mm	97,5 mm	30 mm
ST45/5/3L	€ 59,40	5	3	268 mm	118,5 mm	36 mm
ST45/5/4L	€ 67,30	5	4	300 mm	150,5 mm	48 mm
ST45/5/5L	€ 98,40	5	5	335 mm	185,5 mm	63 mm
ST45/5/6L	€ 169,00	5	6	396 mm	247 mm	82 mm

A001-

ATTACCO PER MANDRINO

Per mandrini con attacco conico DIN 238



Art.	€	Attacco conico CM	Attacco DIN
A001/2/12	€ 9,00	2	B12
A001/2/16	€ 10,20	2	B16
A001/2/18	€ 10,60	2	B18
A001/3/12	€ 15,80	3	B12
A001/3/16	€ 15,80	3	B16
A001/3/18	€ 15,80	3	B18
A001/3/22	€ 15,80	3	B22
A001/4/16	€ 19,00	4	B16
A001/4/18	€ 19,00	4	B18
A001/4/22	€ 19,00	4	B22

ST45-

BUSSOLA DI RIDUZIONE

Per il montaggio di utensili con gambo conico morse DIN 2185



Art.	€	CM Esterno	CM Interno
ST45/2/1	€ 11,30	2	1
ST45/3/1	€ 13,80	3	1
ST45/3/2	€ 14,70	3	2
ST45/4/1	€ 19,00	4	1
ST45/4/2	€ 19,00	4	2
ST45/4/3	€ 19,00	4	3
ST45/5/3	€ 30,30	5	3
ST45/5/4	€ 30,30	5	4

E002-

ESTRATTORI PER CONO MORSE

DIN 317, per estrazione coni



Art.	€	CM
E002/12	€ 7,80	1-2
E002/3	€ 7,80	3
E002/4	€ 11,30	4

3-CM

PORTA PINZA

DIN 228/A per il montaggio di utensili con gambo cilindrico su pinze DIN 6499 (ER).
Fornito con ghiera di serraggio

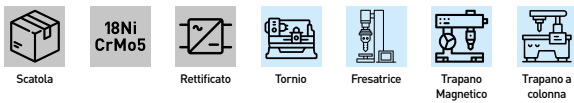
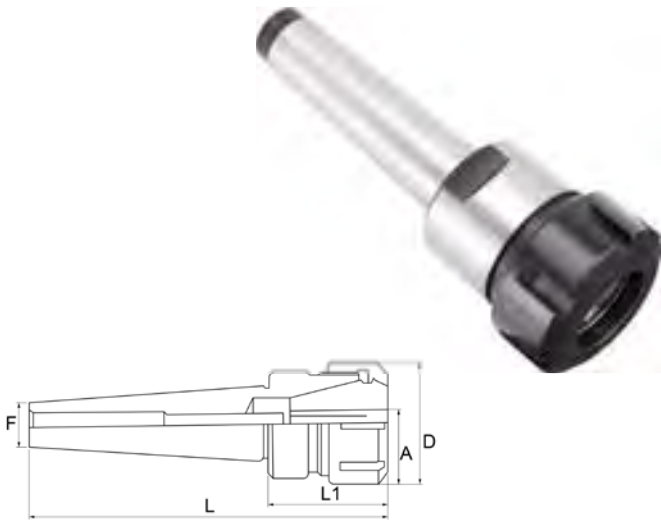

Art.	€	Pinze	D	L	L1	F	A
3/CM2	€ 87,90	ER 32	50 mm	135 mm	60 mm	M 10	3/20 mm
3/CM3	€ 87,90	ER 32	50 mm	146 mm	60 mm	M 12	3/20 mm
3/CM4	€ 98,70	ER 32	50 mm	166 mm	58 mm	M 16	3/20 mm

3/B/40

€ 102,00

PORTA PINZA

DIN 2080, per il montaggio di utensili con gambo cilindrico su pinze DIN 6499 (ER).
Fornito con ghiera di serraggio

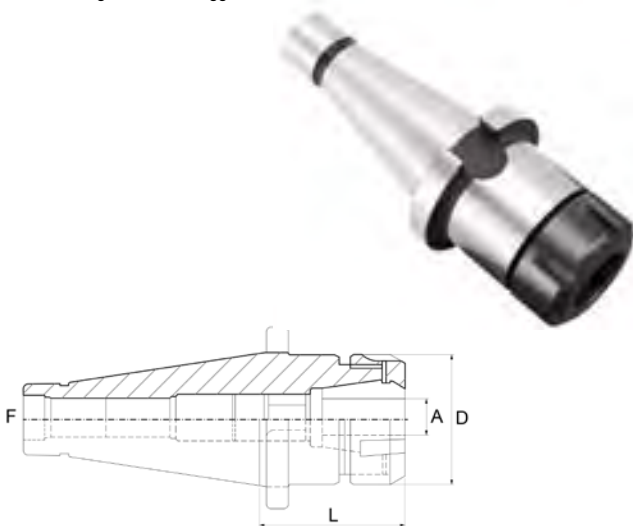

Pinze	ER 32
A	3/20 mm
D	50 mm
L	65 mm
F	M 16
Equilibratura rpm	2000

3A40-

PORTA PINZA

DIN 69871/A, per il montaggio di utensili con gambo cilindrico su pinze DIN 6499 (ER).
Fornito con ghiera di serraggio

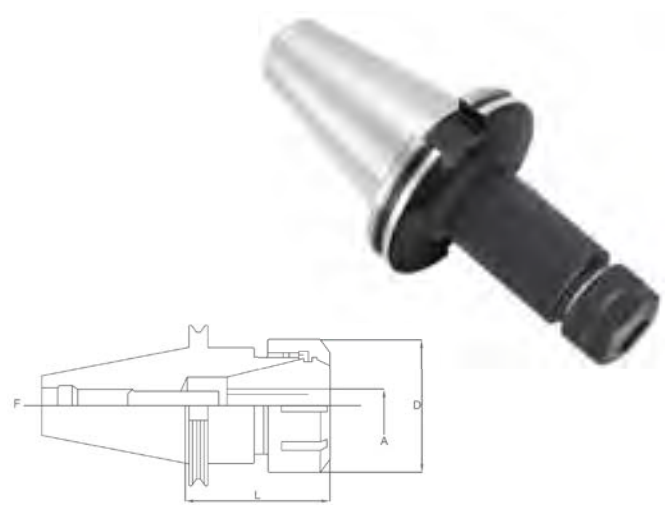

Art.	€	Pinze	A	D	L	F	Equilibratura rpm
3A40/16	€ 70,30	ER 16	1/10 mm	28 mm	100 mm	M 16	12000
3A40/20	€ 70,30	ER 20	2/13 mm	34 mm	100 mm	M 16	12000
3A40/25	€ 70,30	ER 25	2/16 mm	42 mm	100 mm	M 16	12000
3/A/40	€ 111,00	ER 32	3/20 mm	50 mm	72 mm	M 16	12000

3D40-

PORTA PINZA

MAS-403 BT, per il montaggio di utensili con gambo cilindrico su pinze DIN 6499 (ER).
Fornito con ghiera di serraggio

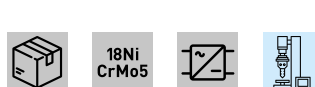
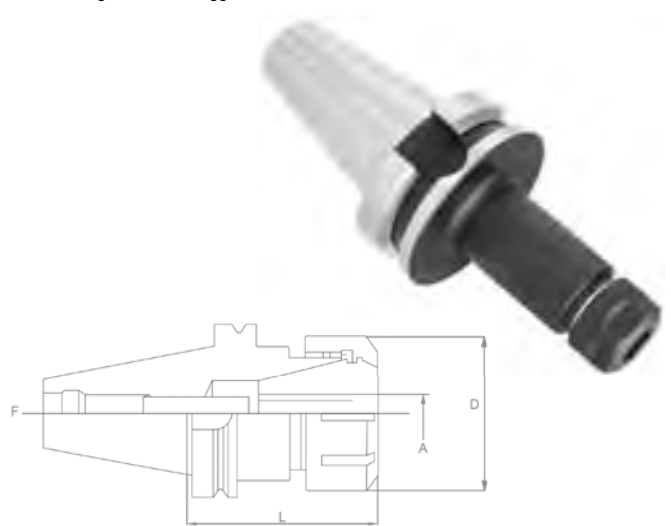

Art.	€	Pinze	A	D	L	F	Equilibratura rpm
3D40/16	€ 70,30	ER 16	1/10 mm	28 mm	100 mm	M 16	12000
3D40/20	€ 70,30	ER 20	2/13 mm	34 mm	100 mm	M 16	12000
3D40/25	€ 70,30	ER 25	2/16 mm	42 mm	100 mm	M 16	12000
3/D/40	€ 111,00	ER 32	3/20 mm	50 mm	63 mm	M 16	12000

PR16/10P € 86,70

SERIE PINZE ER16

ER16 DIN 6499/B, utilizzabili con mandrini portapinzine



Misure \emptyset 1-2-3-4-5-6-7-8-9-10 mm

PR20/12P € 96,80

SERIE PINZE ER20

ER20 DIN 6499/B, utilizzabili con mandrini portapinzine



Misure \emptyset 2-3-4-5-6-7-8-9-10-11-12-13 mm

PR25/15P € 127,00

SERIE PINZE ER25

ER25 DIN 6499/B, utilizzabili con mandrini portapinzine



Misure \emptyset 2-3-4-5-6-7-8-9-10-11-12-13-14-15-16 mm

P032/7P € 117,00

SERIE PINZE ER32



Misure 4-6-8-10-12-16-20 mm

P032- PINZA

ER32 DIN 6499-B utilizzabile con mandrini portapinzine

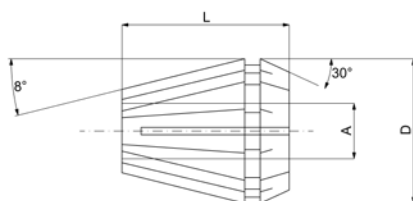

Art.	€	Capacità A	D	L
P032/03	€ 14,30	2-3 mm	33 mm	40 mm
P032/04	€ 14,30	3-4 mm	33 mm	40 mm
P032/05	€ 14,30	4-5 mm	33 mm	40 mm
P032/06	€ 14,30	5-6 mm	33 mm	40 mm
P032/07	€ 14,30	6-7 mm	33 mm	40 mm
P032/08	€ 14,30	7-8 mm	33 mm	40 mm
P032/09	€ 14,30	8-9 mm	33 mm	40 mm
P032/10	€ 14,30	9-10 mm	33 mm	40 mm
P032/11	€ 14,30	10-11 mm	33 mm	40 mm
P032/12	€ 14,30	11-12 mm	33 mm	40 mm
P032/13	€ 14,30	12-13 mm	33 mm	40 mm
P032/14	€ 14,30	13-14 mm	33 mm	40 mm
P032/15	€ 14,30	14-15 mm	33 mm	40 mm
P032/16	€ 14,30	15-16 mm	33 mm	40 mm
P032/17	€ 14,30	16-17 mm	33 mm	40 mm
P032/18	€ 14,30	17-18 mm	33 mm	40 mm
P032/19	€ 14,30	18-19 mm	33 mm	40 mm
P032/20	€ 14,30	19-20 mm	33 mm	40 mm

P032/18P € 245,00

SERIE PINZE ER32



Misure 3-4-5-6-7-8-9-10-11-12-13-14-15-16-17-18-19-20 mm

G0x

GHIERA DI RICAMBIO

ER DIN 6499.



Art.	€
G016	€ 9,40
G020	€ 10,30
G025	€ 14,10
G032	€ 35,40



CHERx

CHIAVE PER GHIERE

DIN 6499.



Art.	€
CHER25	€ 15,10
CHER32	€ 19,20



16-CM

MANDRINO CONO MORSE COMBINATO

DIN 228/A per frese cilindriche frontali secondo norma DIN 481, per frese con scanalatura longitudinale DIN 1880 e per frese ad inserti DIN 1830. Fornito con vite a croce, anello di trascinamento e chiavetta

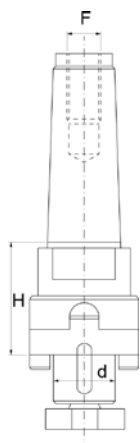

Scatola
 18Ni CrMo5
 Rettificato
 Fresatrice

Art.	€	d - h6	Attacco conico CM	F	H
16/CM3	€ 93,10	16 mm	3	M 12	40 mm
16/CM4	€ 93,10	16 mm	4	M 16	55 mm
22/CM3	€ 93,10	22 mm	3	M 12	50 mm
22/CM4	€ 93,10	22 mm	4	M 16	55 mm
27/CM3	€ 93,10	27 mm	3	M 12	50 mm
27/CM4	€ 93,10	27 mm	4	M 16	55 mm

16Ax

MANDRINO PORTA FRESE COMBINATO

DIN 69871/A, corpo mandrino bilanciato, per frese cilindriche frontali secondo norma DIN 481, per frese con scanalatura longitudinale DIN 1880 e per frese ad inserti DIN 1830. Fornito con vite a croce, anello di trascinamento e chiavetta

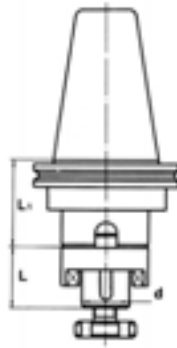

Scatola
 18Ni CrMo5
 Rettificato
 Fresatrice

Art.	€	ISO	d-h6	L	L1	Equilibratura rpm
16A40	€ 108,00	40	16 mm	27 mm	35 mm	12000
22A40	€ 108,00	40	22 mm	31 mm	41 mm	12000
27A40	€ 108,00	40	27 mm	33 mm	41 mm	12000
32A40	€ 120,00	40	32 mm	38 mm	45 mm	12000
16A50	€ 150,00	50	16 mm	27 mm	35 mm	12000
22A50	€ 150,00	50	22 mm	31 mm	35 mm	12000
27A50	€ 150,00	50	27 mm	33 mm	35 mm	12000
32A50	€ 160,00	50	32 mm	38 mm	40 mm	12000
40A50	€ 175,00	50	40 mm	41 mm	40 mm	12000

16-B

MANDRINO PORTA FRESE COMBINATO

DIN 2080, corpo mandrino bilanciato, per frese cilindriche frontali secondo norma DIN 481, per frese con scanalatura longitudinale DIN 1880 e per frese ad inserti DIN 1830. Fornito con vite a croce, anello di trascinamento e chiavetta

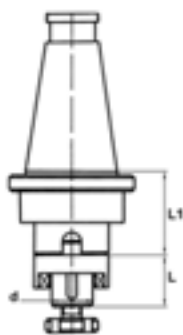

Scatola
 18Ni CrMo5
 Rettificato
 Fresatrice

Art.	€	ISO	d - h6	L	L1	Equilibratura rpm
16/B40	€ 119,00	40	16 mm	27 mm	35 mm	2000
22/B40	€ 119,00	40	22 mm	31 mm	39 mm	2000
27/B40	€ 119,00	40	27 mm	33 mm	40 mm	2000
32/B40	€ 119,00	40	32 mm	38 mm	40 mm	2000
16/B50	€ 144,00	50	16 mm	27 mm	35 mm	2000
22/B50	€ 144,00	50	22 mm	31 mm	35 mm	2000
27/B50	€ 144,00	50	27 mm	33 mm	35 mm	2000
32/B50	€ 154,00	50	32 mm	38 mm	40 mm	2000
40/B50	€ 166,00	50	40 mm	41 mm	40 mm	2000

16-D

MANDRINO PORTA FRESE COMBINATO

MAS-403 BT, corpo mandrino bilanciato, per frese cilindriche frontali secondo norma DIN 481, per frese con scanalatura longitudinale DIN 1880 e per frese ad inserti DIN 1830. Fornito con vite a croce, anello di trascinamento e chiavetta

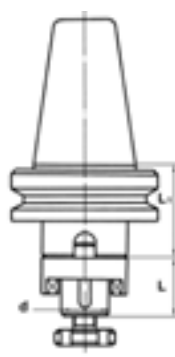

Scatola
 18Ni CrMo5
 Temprato
 Rettificato
 Fresatrice

Art.	€	BT	d - h6	L	L1	Equilibratura rpm
16/D40	€ 108,00	40	16 mm	27 mm	35 mm	12000
22/D40	€ 108,00	40	22 mm	31 mm	35 mm	12000
27/D40	€ 108,00	40	27 mm	33 mm	35 mm	12000
32/D40	€ 120,00	40	32 mm	38 mm	40 mm	12000
16/D50	€ 151,00	50	16 mm	27 mm	35 mm	12000
22/D50	€ 151,00	50	22 mm	31 mm	35 mm	12000
27/D50	€ 161,00	50	27 mm	33 mm	35 mm	12000
32/D50	€ 161,00	50	32 mm	38 mm	40 mm	12000
40/D50	€ 172,00	50	40 mm	41 mm	40 mm	12000

M004-

MANDRINO CON LUBRIFICAZIONE INTERNA PER FRESE A CAROTARE

Con sistema per la lubrificazione della fresa dall'interno durante la foratura

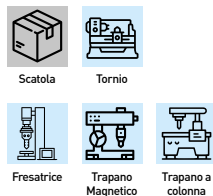

Art.	€	Attacco conico CM	Lunghezza totale	Attacco femmina
M004/2	€ 177,00	2	170,5 mm	Weldon 19,05 mm
M004/3	€ 177,00	3	190,5 mm	Weldon 19,05 mm

4-

MANDRINO PORTA FRESE TIPO WELDON

DIN 69871/A, corpo mandrino bilanciato, per frese (Weldon) secondo norma DIN 1835 B e DIN 6535 HB. Fornito con vite di serraggio

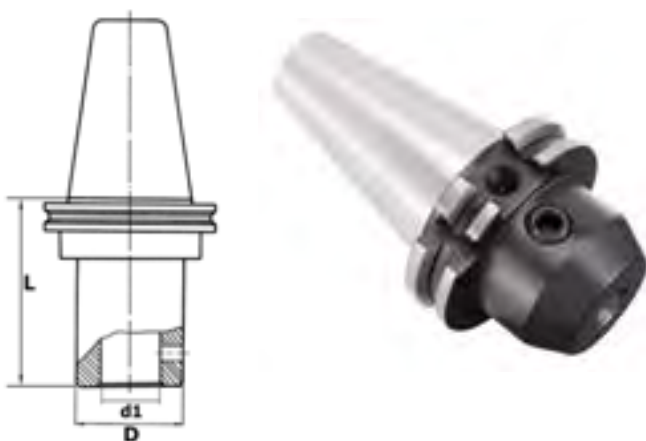

Art.	€	ISO	d1 - h6	D	L	Equilibratura rpm
4/06A40	€ 87,90	40	6 mm	25 mm	60 mm	12000
4/08A40	€ 87,90	40	8 mm	28 mm	60 mm	12000
4/10A40	€ 87,90	40	10 mm	35 mm	50 mm	12000
4/12A40	€ 87,90	40	12 mm	42 mm	60 mm	12000
4/14A40	€ 87,90	40	14 mm	42 mm	70 mm	12000
4/16A40	€ 87,90	40	16 mm	48 mm	70 mm	12000
4/18A40	€ 87,90	40	18 mm	48 mm	70 mm	12000
4/20A40	€ 87,90	40	20 mm	52 mm	63 mm	12000
4/25A40	€ 87,90	40	25 mm	65 mm	100 mm	12000
4/32A40	€ 87,90	40	32 mm	72 mm	100 mm	12000
4/06A50	€ 121,00	50	6 mm	25 mm	65 mm	12000
4/08A50	€ 121,00	50	8 mm	28 mm	65 mm	12000
4/10A50	€ 121,00	50	10 mm	35 mm	70 mm	12000
4/12A50	€ 121,00	50	12 mm	42 mm	75 mm	12000
4/14A50	€ 121,00	50	14 mm	42 mm	75 mm	12000
4/16A50	€ 121,00	50	16 mm	48 mm	80 mm	12000
4/18A50	€ 121,00	50	18 mm	48 mm	80 mm	12000
4/20A50	€ 121,00	50	20 mm	52 mm	80 mm	12000
4/25A50	€ 128,00	50	25 mm	65 mm	100 mm	12000
4/32A50	€ 128,00	50	32 mm	72 mm	105 mm	12000
4/40A50	€ 139,00	50	40 mm	80 mm	120 mm	12000

4-xB

MANDRINO PORTAFRESE TIPO WELDON

MAS-403 BT, corpo mandrino bilanciato, per frese (Weldon) secondo norma DIN 1835 B e DIN 6535 HB. Fornito con vite di serraggio



Art.	€	ISO	d1 - h6	D	L	Equilibratura rpm
4/06B40	€ 118,00	40	6 mm	25 mm	50 mm	2000
4/08B40	€ 118,00	40	8 mm	28 mm	50 mm	2000
4/10B40	€ 118,00	40	10 mm	35 mm	50 mm	2000
4/12B40	€ 118,00	40	12 mm	42 mm	50 mm	2000
4/16B40	€ 118,00	40	16 mm	48 mm	63 mm	2000
4/18B40	€ 118,00	40	18 mm	48 mm	50 mm	2000
4/20B40	€ 118,00	40	20 mm	52 mm	63 mm	2000
4/25B40	€ 118,00	40	25 mm	65 mm	100 mm	2000
4/32B40	€ 118,00	40	32 mm	72 mm	80 mm	2000
4/06B50	€ 128,00	50	6 mm	25 mm	50 mm	2000
4/08B50	€ 128,00	50	8 mm	28 mm	50 mm	2000
4/10B50	€ 128,00	50	10 mm	35 mm	50 mm	2000
4/12B50	€ 128,00	50	12 mm	42 mm	50 mm	2000
4/16B50	€ 128,00	50	16 mm	48 mm	50 mm	2000
4/20B50	€ 140,00	50	20 mm	52 mm	63 mm	2000
4/25B50	€ 140,00	50	25 mm	65 mm	80 mm	2000
4/32B50	€ 140,00	50	32 mm	72 mm	80 mm	2000
4/40B50	€ 151,00	50	40 mm	90 mm	90 mm	2000

4-xD

MANDRINO PORTA FRESE TIPO WELDON

MAS-403 BT, corpo mandrino bilanciato, per frese (Weldon) secondo norma DIN 1835 B e DIN 6535 HB. Fornito con vite di serraggio.

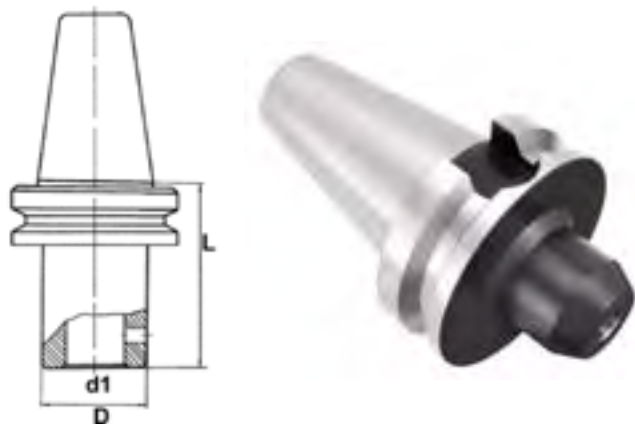

Art.	€	BT	d1 - h6	D	L	Equilibratura rpm
4/06D40	€ 95,30	40	6 mm	25 mm	60 mm	12000
4/08D40	€ 95,30	40	8 mm	28 mm	60 mm	12000
4/10D40	€ 95,30	40	10 mm	35 mm	60 mm	12000
4/12D40	€ 95,30	40	12 mm	42 mm	70 mm	12000
4/14D40	€ 95,30	40	14 mm	42 mm	70 mm	12000
4/16D40	€ 95,30	40	16 mm	48 mm	70 mm	12000
4/18D40	€ 95,30	40	18 mm	48 mm	70 mm	12000
4/20D40	€ 95,30	40	20 mm	52 mm	75 mm	12000
4/25D40	€ 95,30	40	25 mm	63 mm	100 mm	12000
4/32D40	€ 95,30	40	32 mm	72 mm	100 mm	12000
4/06D50	€ 126,00	50	6 mm	25 mm	65 mm	12000
4/08D50	€ 126,00	50	8 mm	28 mm	65 mm	12000
4/10D50	€ 126,00	50	10 mm	35 mm	70 mm	12000
4/12D50	€ 126,00	50	12 mm	42 mm	75 mm	12000
4/14D50	€ 126,00	50	14 mm	42 mm	75 mm	12000
4/16D50	€ 126,00	50	16 mm	48 mm	80 mm	12000
4/18D50	€ 126,00	50	18 mm	48 mm	80 mm	12000
4/20D50	€ 126,00	50	20 mm	52 mm	80 mm	12000
4/25D50	€ 140,00	50	25 mm	65 mm	100 mm	12000
4/32D50	€ 140,00	50	32 mm	72 mm	105 mm	12000
4/40D50	€ 140,00	50	40 mm	80 mm	120 mm	12000

2-xA

MANDRINO PORTA FRESE A GAMBO CONICO

DIN 69871/A, corpo mandrino bilanciato



Art.	€	ISO	CM	D	L	Equilibratura rpm
2/1A40	€ 121,00	40	1	25 mm	45 mm	12000
2/2A40	€ 121,00	40	2	32 mm	60 mm	12000
2/3A40	€ 121,00	40	3	40 mm	75 mm	12000
2/4A40	€ 121,00	40	4	50 mm	98 mm	12000
2/2A50	€ 150,00	50	2	32 mm	40 mm	12000
2/3A50	€ 150,00	50	3	40 mm	50 mm	12000
2/4A50	€ 170,00	50	4	50 mm	80 mm	12000
2/5A50	€ 201,00	50	5	63 mm	110 mm	12000

2-xB

MANDRINO PORTA FRESE A GAMBO CONICO

DIN 2080, corpo mandrino bilanciato



Art.	€	ISO	CM	D	L	Equilibratura rpm
2/1B40	€ 116,00	40	1	25 mm	15 mm	2000
2/2B40	€ 116,00	40	2	32 mm	30 mm	2000
2/3B40	€ 116,00	40	3	40 mm	64 mm	2000
2/4B40	€ 129,00	40	4	50 mm	94 mm	2000
2/2B50	€ 156,00	50	2	32 mm	20 mm	2000
2/3B50	€ 156,00	50	3	40 mm	30 mm	2000
2/4B50	€ 170,00	50	4	50 mm	65 mm	2000
2/5B50	€ 185,00	50	5	63 mm	105 mm	2000

2-xD

MANDRINO PORTA FRESA A GAMBO CONICO

MAS-403 BT, corpo mandrino bilanciato



Art.	€	BT	CM	D	L	Equilibratura rpm
2/1D40	€ 116,00	40	1	25 mm	45 mm	12000
2/2D40	€ 116,00	40	2	32 mm	60 mm	12000
2/3D40	€ 116,00	40	3	40 mm	75 mm	12000
2/4D40	€ 121,00	40	4	50 mm	98 mm	12000
2/2D50	€ 154,00	50	2	32 mm	40 mm	12000
2/3D50	€ 154,00	50	3	40 mm	75 mm	12000
2/4D50	€ 179,00	50	4	50 mm	80 mm	12000
2/5D50	€ 203,00	50	5	63 mm	110 mm	12000

TIPAx

CODOLINO

DIN 69871/A.



Art.	€	ISO
TIPA40	€ 17,90	40
TIPA50	€ 19,00	50



TIPDx

CODOLINO

MAS-403 BT



Art.	€	ISO
TIPD40	€ 17,90	40
TIPD50	€ 19,00	50



M059-

MASCHIATORE A FRIZIONE REGISTRABILE CON INVERSIONE

Il dispositivo di sicurezza regolabile con frizione riduce la possibilità di rottura del maschio durante l'esecuzione della filettatura. Invertitore di rotazione incorporato, subito attivo al cambio del dispositivo di avanzamento. Frizione regolabile in 4 posizioni. Dotato di 2 pinze flessibili e chiavi per utilizzo.

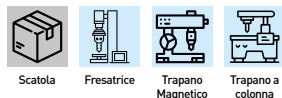

Art.	€	Campo maschiatura	Dimensioni senza CM	Attacco conico CM	Attacco DIN
M059/07	€ 481,00	M 2 - 7	Ø 55 x 130h mm	2	B16
M059/12	€ 551,00	M 5 - 12	Ø 75 x 162h mm	3	B16
M059/20	€ 674,00	M 8 - 20	Ø 91 x 204h mm	4	B22



M060-

MASCHIATORE CON BUSSOLE

Grazie alla compensazione si riduce sensibilmente la possibilità di rottura del maschio durante l'operazione di filettatura. Possibilità di regolazione dell'intensità della compensazione. Dotato di 6 bussole con attacco Ø 19mm. Bussole per quadro: 3,5 x 2,7mm - 4,5 x 3,4mm - 6 x 4,9mm - 8 x 6,2mm - 10 x 8mm - 9 x 7mm

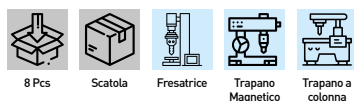

Art.	€	Campo maschiatura	Lunghezza mandrino con e senza bussola	Attacco conico CM
M060/2	€ 444,00	M 3 - 12	213 - 175 - Ø 46 mm	2
M060/3	€ 444,00	M 3 - 12	228 - 190 - Ø 46 mm	3
M060/4	€ 475,00	M 3 - 12	253 - 215 - Ø 46 mm	4



T021-

TESTINA PER ALESARE CENTESIMALE CON AVANZAMENTO AUTOMATICO

Per correggere lievemente l'assialità e il diametro dei fori. Può funzionare in modo automatico e manuale



Art.	€
T021/030	€ 1890,00
T021/030CM3	€ 1890,00
T021/050	€ 2200,00
T021/100	€ 2540,00
T021/100/50	€ 2540,00

	T021/030 T021/030CM3	T021/050	T021/100 T021/100/50
Diametro max di spianatura e foratura	150 mmv	350 mm	450 mm
Max spostamento della slitta	± 15 mm	± 25 mm	± 50 mm
Avanzamento fine	0,005 mm	0,005 mm	0,005 mm
Avanzamento manuale per giro	2 mm	3 mm	3 mm
Avanzamento automatico per giro	0,02-0,04-0,06 0,08-0,10-0,12 mm	0,03-0,06-0,09 0,12-0,15-0,18 mm	0,03-0,06-0,09 0,12-0,15-0,18 mm
Diametro dei fori della testina	18 mm	22 mm	22 mm
Diametro della testina	90 mm	120 mm	168 mm
Altezza della testina senza attacco	87,5 mm	118 mm	118 mm
Peso della testina senza attacco	2,9 kg	6,1 kg	7,8 kg
Lunghezza della testa	75 mm	105 mm	160 mm
Larghezza della testa	70 mm	90 mm	90 mm
Foro pinze	4 - 8 - 12 mm	8 - 10 - 12 - 14 mm	8 - 10 - 12 - 14 mm
Accessori in dotazione	1 - 2 - 6	1 - 2 - 3 - 4 - 5	1 - 2 - 3 - 4 - 5
Foro prolunga per utensile	Ø 6 mm	Ø 10 mm	Ø 10 mm

T010-

TESTINA PER ALESARE CENTESIMALE

Kit utensili non compreso, per correggere lievemente l'assialità e il diametro dei fori

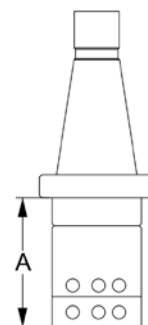
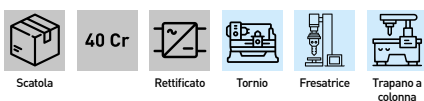

Art.	€	Corpo testina	Attacco	Bareni	Spostamento	A
T010/5003	€ 264,00	Ø 50 mm	CM/MT3-DIN228A	Ø 12 mm	15 mm	75 mm
T010/5004	€ 264,00	Ø 50 mm	CM/MT4-DIN228A	Ø 12 mm	15 mm	75 mm
T010/5040	€ 264,00	Ø 50 mm	ISO 40-DIN2080	Ø 12 mm	15 mm	81 mm
T010/7540	€ 302,00	Ø 75 mm	ISO 40-DIN2080	Ø 18 mm	25 mm	99 mm

B001-

SET UTENSILI PER TESTE ALESARE

Per le varie lavorazioni di alesatura



Art.	€	Adattabile	Stelo	Lunghezza	Vite	Inserito [non incluso]
B001/12	€ 122,00	T010/50	12 Ø mm	60 mm	KV250	TCMT110204N
B001/18	€ 122,00	T010/75	18 Ø mm	99 mm	KV250	TCMT110204N

S007-

PRO

SMONTA MANDRINO INCLINABILE

DIN 2080, DIN 69871/A e MAS BT-TC, consente l'orientamento dei portautensili sugli assi verticali e orizzontali per facilitare il montaggio degli utensili. Il cono dei portautensili è protetto da due anelli O-Ring opportunamente posizionati. Cono in acciaio, leve di manovra in materiale termoplastico, base da fissare al banco di lavoro con 4 viti



Art.	€	Dimensioni	Base	Conicità
S007/30	€ 223,00	230 x h150mm	Ø 150 mm	ISO 30 DIN 2080 - SK30 DIN 69871 - BT30 - CAT30 - HSK50A - CAPTO C5
S007/40	€ 227,00	235 x h155mm	Ø 150 mm	ISO 40 DIN 2080 - SK40 DIN 69871 - BT40 - CAT40 - HSK63A - CAPTO C6
S007/50	€ 254,00	265 x h200mm	Ø 180 mm	ISO 50 DIN 2080 - SK50 DIN 69871 - BT50 - CAT50 - HSK100A - CAPTO C10

P450

€ 528,00

CARRELLO PORTACONI

Dotato di pareti fessurate con l'inserimento di telai portaboccole, maniglia per il trasporto. Fornito in kit di montaggio con 20 portaconi



Dimensioni	950 x 650 x 830h mm
Conicità	ISO 50

P350

€ 184,00

SUPPORTI PORTACONI DA BANCO

Telaio posizionabile su banco da lavoro o sugli armadi, predisposto per l'inserimento delle boccole portautensili su tre file. Fornito in kit di montaggio con 15 portaconi

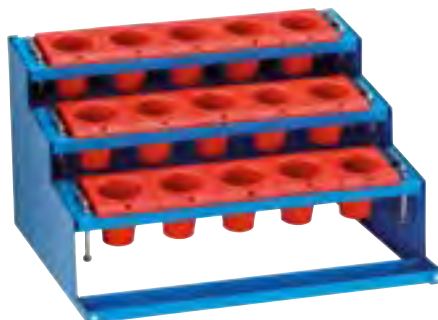

Dimensioni	600 x 500 x 350h mm
Conicità	ISO 50

S014-

SMONTA MANDRINO

Dotato di postazione verticale e orizzontale. Base con 4 fori di staffaggio per poterlo fissare al banco di lavoro



Art.	€	Mandrino
S014/40BT	€ 78,50	BT 40 ISO 40
S014/40DIN	€ 78,50	DIN 69871.40 ISO 40
S014/50BT	€ 178,00	BT 50 ISO 50
S014/50DIN	€ 178,00	DIN 69871.50 ISO 50

P440

€ 475,00

CARRELLO PORTACONI

Dotato di pareti fessurate con l'inserimento di telai portaboccole, maniglia per il trasporto. Fornito in kit di montaggio con 28 portaconi



Dimensioni	950 x 650 x 830h mm
Conicità	ISO 40

P340

€ 190,00

SUPPORTI PORTACONI DA BANCO

Telaio posizionabile su banco da lavoro o sugli armadi, predisposto per l'inserimento delle boccole portautensili su tre file. Fornito in kit di montaggio con 21 portaconi



Dimensioni	600 x 500 x 350h mm
Conicità	ISO 40

PC50 € 50,60

MENSOLE PORTACONI

Dotato di maniglie per la movimentazione. Fornito con 5 portaconi



Scatola

Dimensioni 600 x 145 mm
Conicità ISO 50

PC40 € 50,60

MENSOLE PORTACONI

Dotato di maniglie per la movimentazione. Fornito con 7 portaconi.



Scatola

Dimensioni 600 x 145 mm
Conicità ISO 40

PC50/R € 53,50

BOCCOLE PORTACONO

Fissaggio mediante perno.



10 Pcs



Scatola

Plastic

Dimensioni 136 x 102 mm
Conicità ISO 50

PC40/R € 49,90

BOCCOLE PORTACONO

Fissaggio mediante perno.



10 Pcs



Scatola

Plastic

Dimensioni 136 x 72 mm
Conicità ISO 40

P4CS € 20,00

COPPIA SUPPORTI MENSOLA

Per carrello



PC4P € 21,40

SERIE 4 PIEDINI

Per mensola portaconi





C046-

CONTROPUNTA ROTANTE

Utilizzate principalmente nei torni con l'obiettivo di stabilizzare i pezzi lunghi e sottili, più soggetti alla flessione o all'oscillazione incontrollata causate dalle forze generate durante la lavorazione

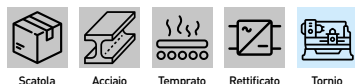

Art.	€	Attacco conico CM	Cuspide	Corpo	Lunghezza	Max rpm	Portata max
C046/2	€ 71,70	2	60° - max Ø21mm	Ø 45 mm	152 mm	2500 g/min	50 kg
C046/3	€ 87,00	3	60° - max Ø27mm	Ø 53 mm	180 mm	2500 g/min	75 kg
C046/4	€ 92,20	4	60° - max Ø29mm	Ø 63 mm	218 mm	2000 g/min	150 kg
C046/5	€ 127,00	5	60° - max Ø37mm	Ø 87 mm	276 mm	2000 g/min	200 kg

C050-

SET CONTROPUNTA GIREVOLE

Utilizzate principalmente nei torni con l'obiettivo di stabilizzare i pezzi lunghi e sottili, più soggetti alla flessione o all'oscillazione incontrollata causate dalle forze generate durante la lavorazione. Completo di 7 inserti intercambiabili ed estrattore per gli inserti

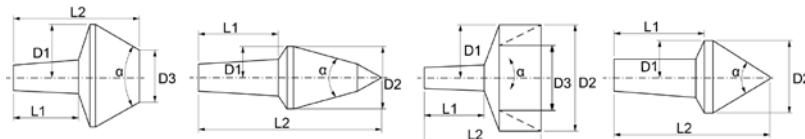

Art.	€	CM	A	B	C	D	E	F	G
C050/2	€ 173,00	2	L2 39 mm - D2-D3 16 mm - α 60° mm	L2 35,5 mm - D2-D3 16 mm - α 75° mm	L2 33 mm - D2-D3 16 mm - α 90° mm	L2 46 mm - D2-D3 16 mm - α 60° mm	L2 40 mm - D2-D3 25 mm / 10 mm - α 60° mm	L2 36 mm - D2-D3 16 mm / 10 mm - α 60° mm	L2 39 mm - D2-D3 20 mm / 16 mm - α 60° mm
C050/3	€ 194,00	3	L2 48 mm - D2-D3 20 mm - α 60° mm	L2 43,5 mm - D2-D3 20 mm - α 75° mm	L2 40,5 mm - D2-D3 20 mm - α 90° mm	L2 56 mm - D2-D3 18 mm - α 60° mm	L2 50 mm - D2-D3 35 mm / 15 mm - α 60° mm	L2 42 mm - D2-D3 22 mm / 18 mm - α 60° mm	L2 48 mm - D2-D3 35 mm / 30 mm - α 60° mm
C050/4	€ 282,00	4	L2 61,5 mm - D2-D3 28 mm - α 60° mm	L2 55,5 mm - D2-D3 28 mm - α 75° mm	L2 51,5 mm - D2-D3 28 mm - α 90° mm	L2 73 mm - D2-D3 26 mm - α 60° mm	L2 61,5 mm - D2-D3 55 mm / 30 mm - α 60° mm	L2 55 mm - D2-D3 40 mm / 35 mm - α 60° mm	L2 60 mm - D2-D3 55 mm / 48 mm - α 60° mm

C055-

CONTROPUNTA ROTANTE PER TUBI

Per tornitura e rettifica di tubi e corpi cavi

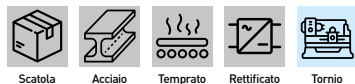

Art.	€	Attacco conico CM	Ø	Lunghezza	Max rpm	Portata max
C055/3	€ 207,00	3	60° - 30 ÷ 100 mm	170 mm	2500 g/min	200 kg
C055/4	€ 293,00	4	60° - 40 ÷ 160 mm	230 mm	1600 g/min	350 kg
C055/5	€ 410,00	5	60° - 66 ÷ 200 mm	260 mm	1500 g/min	350 kg

C053-

CONTROPUNTA FISSA CON CUSPIDE IN METALLO DURO

Utilizzate principalmente nei torni con l'obiettivo di stabilizzare i pezzi lunghi e sottili, più soggetti alla flessione o all'oscillazione incontrollata causate dalle forze generate durante la lavorazione



Art.	€	Attacco conico CM	Cuspide in metallo duro max	Lunghezza
C053/2	€ 18,80	2	60° - max Ø 8 mm	100 mm
C053/3	€ 20,80	3	60° - max Ø 11 mm	125 mm
C053/4	€ 30,70	4	60° - max Ø 13 mm	160 mm
C053/5	€ 47,60	5	60° - max Ø 17 mm	200 mm

COME SCEGLIERE LA TORRETTA

ALTEZZA PUNTE TORNIO	TORRETTA TIPO
90 mm	A0
120 mm	A1
140 mm	A
150 - 200 mm	E
200 - 250 mm	B
250 - 350 mm	C

0688

€ 196,00

APPARECCHIO UNIVERSALE A FRESARE PER TORNIO

Permette di effettuare una lavorazione superficiale sul pezzo staffato con l'utilizzo del mandrino del tornio come portautensile. Fissaggio mediante adattamento meccanico rispetto alla macchina in cui deve essere applicato

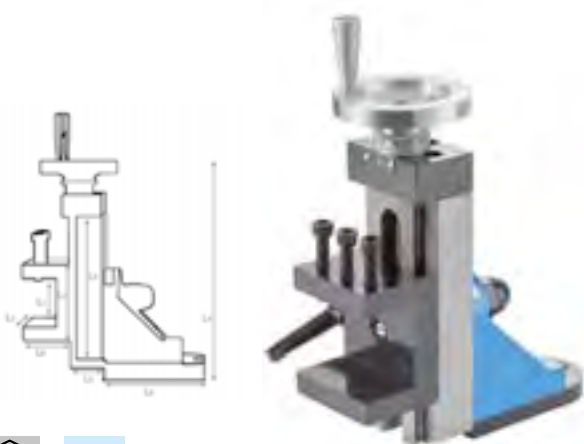

L1	52 mm
L2	80 mm
L3	65 mm
L4	220 mm
L5	37 mm
L6	110 mm
L8	46 mm
L9	150 mm

T00x

TORRETTA PORTA UTENSILI A CAMBIO RAPIDO

Con dentatura di attacco temprata e rettificata. Agendo su di un perno eccentrico, il portautensile viene bloccato sulla dentatura del corpo. Permette una riproducibilità di 40 posizioni angolari possibili del portautensile. Questa precisione viene mantenuta anche dopo innumerevoli cambi dell'utensile. Composto da: 1 torretta portautensili 3 portautensili a sede piana 1 portautensile a sede prismatica

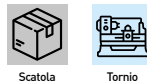

Art.	€	R max	S max	P	H	X min
T00A	€ 799,00	100 mm	54 mm	48 mm	16 mm	30 mm
T00B	€ 1020,00	150 mm	75 mm	71 mm	25 mm	37 mm
T00C	€ 1630,00	202 mm	105 mm	102 mm	32 mm	47 mm
T00E	€ 844,00	125 mm	68 mm	60 mm	20 mm	35 mm



T00x-D

PORTA UTENSILI A SEDE PIANA

Tipo D dotato di vite per la regolazione dell'altezza e 3 viti di serraggio

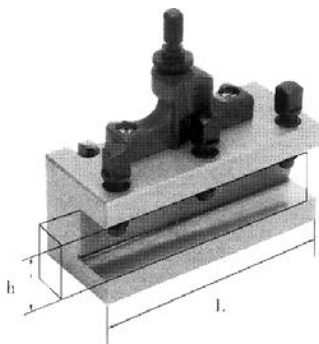

Art.	€	L	h
T00A/D	€ 113,00	80 mm	16 mm
T00B/D	€ 169,00	120 mm	25 mm
T00C/D	€ 261,00	150 mm	32 mm
T00E/D	€ 152,00	100 mm	20 mm

T00x-B

PORTA UTENSILI A SEDE PRISMATICA

Tipo B dotato di vite per la regolazione dell'altezza e 3 viti di serraggio dello stelo

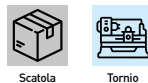
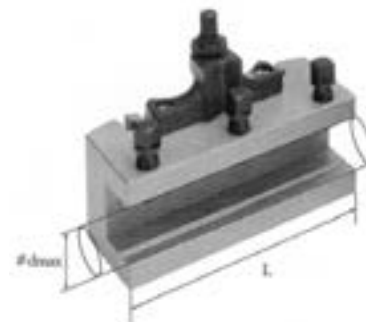

Art.	€	L	d max
T00A/B	€ 118,00	80 mm	20 mm
T00B/B	€ 174,00	130 mm	32 mm
T00C/B	€ 258,00	160 mm	32 mm
T00E/B	€ 169,00	100 mm	30 mm

T00x-S

PORTA UTENSILI PER BUSSOLA

Tipo S, adatto per l'alloggiamento di bussola a cono morse cod. C40142, e per l'alloggiamento diretto di barre di tornitura. Dotato di vite di regolazione e 2 viti di bloccaggio

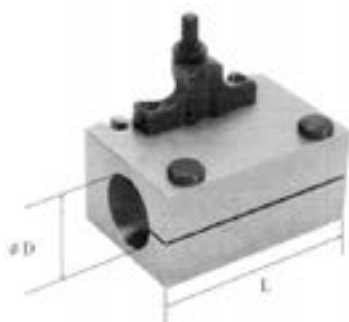

Art.	€	L	D
T00A/S	€ 129,00	80 mm	30 mm
T00B/S	€ 214,00	120 mm	40 mm
T00C/S	€ 302,00	150 mm	40 mm
T00E/S	€ 174,00	100 mm	30 mm

T00x-LC

BUSSOLA A CONO MORSE

Per l'alloggiamento di utensili con attacco CM

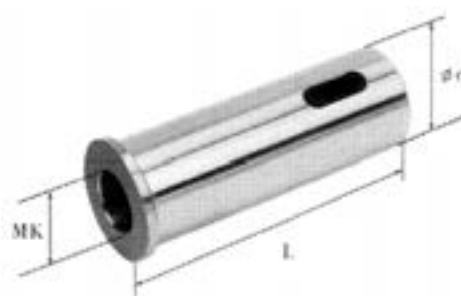

Art.	€	L	d	CM
T00AE/LCM1	€ 37,60	80 mm	30 mm	1
T00AE/LCM2	€ 37,60	95 mm	30 mm	2
T00BC/LCM2	€ 40,70	105 mm	36 mm	2
T00BC/LCM3	€ 40,70	120 mm	40 mm	3
T00BC/LCM4	€ 62,70	150 mm	40 mm	4

TOAx

TORRETTA A CAMBIO RAPIDO

Per cambi utensili rapidi grazie alla leva di blocco/sblocco
Composizione del set:
- 1 torretta portautensili - 4 portautensili a sede piana



Art.	€	Lunghezza	Larghezza	Altezza utile	Foro	H utensile
TOAA	€ 267,00	57 mm	64 mm	56 mm	14,4 mm	14 mm
TOAB	€ 449,00	85 mm	85 mm	76 mm	19,9 mm	20 mm
TOAC	€ 579,00	100 mm	100 mm	92 mm	22,22 mm	25 mm
TOAE	€ 339,00	100 mm	100 mm	90 mm	16,5 mm	20 mm

TOAx-D

PORTAUTENSILI A SEDE PIANA

A cambio rapido con sede piana dotato di vite per la regolazione dell'altezza e 4 viti di serraggio



Art.	€	Lunghezza	Larghezza	Altezza	h utensile
TOAA/D	€ 61,50	76 mm	25,5 mm	38 mm	14 mm
TOAB/D	€ 86,10	108 mm	35 mm	54 mm	20 mm
TOAC/D	€ 101,00	125 mm	40 mm	63 mm	25 mm
TOAE/D	€ 73,70	89 mm	29 mm	45 mm	20 mm

T00A1 € 256,00

TORRETTA A CAMBIO RAPIDO

Per cambi utensili rapidi grazie al perno di blocco/sblocco.
Composizione del set: - 1 torretta portautensili - 3 portautensili a sede piana



Lunghezza	57 mm
Larghezza	57 mm
Altezza	37 mm
Foro	16 mm
h utensile	14 mm

T00A1/PP € 51,60

PORTAUTENSILI A SEDE PIANA

A cambio rapido con sede piana dotato di vite per la regolazione dell'altezza e 4 viti di serraggio



Lunghezza	57 mm
Larghezza	25 mm
Altezza	25 mm
h utensile	12 mm

T00Ax

TORRETTA A CAMBIO RAPIDO

Per cambi utensili rapidi grazie al perno di blocco/sblocco.
Composizione del set: - 1 torretta portautensili - 3 portautensili a sede piana



Art.	€	Lunghezza	Larghezza	Altezza	Foro	h utensile
T00A0	€ 119,00	60 mm	50 mm	30 mm	10 mm	12 mm
T00A1R	€ 158,00	68 mm	68 mm	47 mm	10 mm	19 mm

T00Ax-PP

PORTAUTENSILI A SEDE PIANA

A cambio rapido con sede piana dotato di vite per la regolazione dell'altezza e 2 viti di serraggio



Art.	€	Lunghezza	Larghezza	Altezza	h utensile
T00A0/PP	€ 37,30	50 mm	22 mm	24 mm	12 mm
T00A1R/PP	€ 38,20	66 mm	27 mm	46 mm	19 mm





M038

€ 674,00

AVANZAMENTO AUTOMATICO PER TAVOLE A CROCE

Per asse X, posizione del motore orizzontale, tavola con avanzamento tramite potenziometro regolabile per spostamenti e pulsante per movimenti rapido, inoltre la rotazione del motore è sia in senso orario che antiorario.



Velocità di rotazione	0 ÷ 200 rpm
Coppia max	5,1 Nm
Motore	230 V 50 Hz 0,1 kW
Peso netto	6 kg



P018-

KIT DI REFRIGERAZIONE PER MACCHINE UTENSILI

Per permettere di avere la refrigerazione su macchine quali torni, trapani a colonna, frese non dotate di impianto

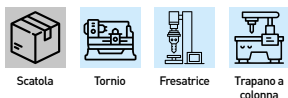

Art.	€	Alimentazione	Capacità serbatoio	Portata pompa
P018/230V	€ 351,00	230V - 50Hz - 40W	10 l	22 l/min
P018/400V	€ 351,00	400V - 50Hz - 40W	10 l	22 l/min



T999/3A

NEW € 1500,00

KIT DI VISUALIZZAZIONE TORNIO

Dotato di visualizzatore a 3 assi, righe di misurazione e cavi di connessione

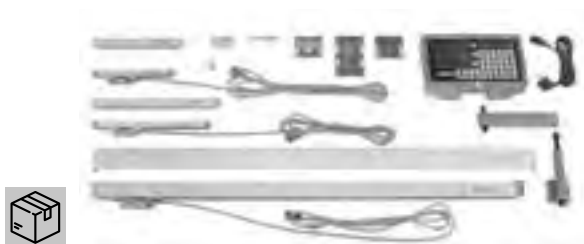

Righe	Trasversale 335 mm Long. torretta 235 mm Long. carro 1170 mm
-------	--

0715-

PRO NEW

SUPPORTO ANTIVIBRANTE

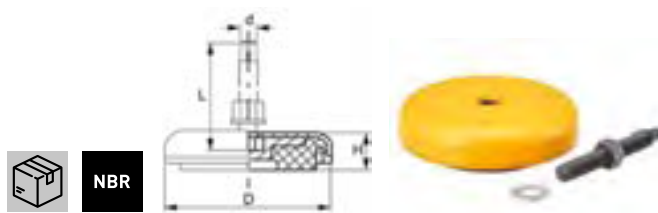

Art.	€	D	d	L	H	Portata
0715/0080	€ 27,80	40 mm	M5	30 mm	15 mm	80 Kg
0715/0400	€ 38,90	80 mm	M10	80 mm	25 mm	400 Kg
0715/1100	€ 55,50	120 mm	M12	100 mm	32 mm	1100 Kg
0715/2000	€ 66,60	160 mm	M16	120 mm	35 mm	2000 Kg

T200

€ 17,20

TUBO COMPONENTE SNODABILE PER LIQUIDI REFRIGERANTI

Adatto per liquidi e aria, resistente alle vibrazioni, diametro interno di 6mm e attacco di 1/4". Completamente ermetico, diametro interno costante in qualsiasi posizione, inalterabile agli agenti chimici normali. Composizione del set: n. 21 segmenti n. 1 ugello: foro Ø 1,5mm n. 1 ugello: foro Ø 3mm n. 1 raccordo: 1/8" n. 1 raccordo: 1/4" n. 1 ugello a spatola.



Lunghezza totale	350 mm
Diametro tubo	6 mm - 1/4"

T201

€ 18,80

TUBO COMPONENTE SNODABILE PER LIQUIDI REFRIGERANTI

Adatto per liquidi e aria, resistente alle vibrazioni, diametro interno di 12mm e attacco di 1/2". Completamente ermetico, diametro interno costante in qualsiasi posizione, inalterabile agli agenti chimici normali. Composizione del set: n. 16 segmenti n. 1 ugello - foro: Ø 5mm n. 1 raccordo: 1/2" n. 1 ugello a spatola.



Lunghezza totale	400 mm
Diametro tubo	12 mm - 1/2"

T338-

TUBO SNODATO IN METALLO CROMATO PER LIQUIDI REFRIGERANTI



Art.	€	Lunghezza totale	Filetto
T338/500	€ 17,80	500 mm	3/8"
T338/600	€ 19,70	600 mm	3/8"

Tx

PROTEZIONE PER TORNIO CON SCHERMO IN LEXAN E STRUTTURA IN ACCIAIO



Art.	€	Dimensioni
T400	€ 186,00	Ø 400 x 200 mm
T500	€ 198,00	Ø 500 x 220 mm
T600	€ 215,00	Ø 600 x 280 mm

P100/250

€ 124,00

PROTEZIONE ANTINFORTUNISTICA PER MACCHINE UTENSILI

Regolabile in altezza con microinterruttore di sicurezza

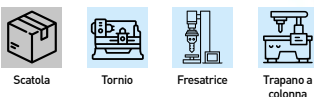

Stelo	400 mm
Schermo	150x250 H x L mm

S100

€ 58,10

PROTEZIONE REGOLABILE PER MOLA CON SCHERMO IN LEXAN



Dimensioni	110 x 120 mm
------------	--------------

Mx

ATTACCO UNIVERSALE PER TORNIO CON MICROINTERRUTTORE DI SICUREZZA



Art.	€	Stelo	Lunghezza
M400	€ 234,00	Ø 30 mm	350 mm
M500	€ 242,00	Ø 30 mm	400 mm
M600	€ 252,00	Ø 30 mm	450 mm

P101-

PROTEZIONE ANTINFORTUNISTICA PER MACCHINE UTENSILI

Con microinterruttore di sicurezza e schermo in lexan

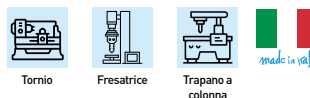

Art.	€	Stelo	Schermo
P101/300	€ 400,00	400L mm	150 x 350 H x L mm
P101/350	€ 421,00	600L mm	200 x 440 H x L mm
P101/400	€ 434,00	500L mm	150 x 370 H x L mm



0531A € 153,00

LAMPADA A LED PER MACCHINE UTENSILI

Snodato, senza trasformatore.



Alimentazione	12 - 24 V 13 W AC/DC
Flusso luminoso	1800 lm
Temperatura colore	6500 K
Numero dei LED	9
Altezza	110 mm
Diametro	125 mm
Snodi	1



0532A € 186,00

LAMPADA A LED PER MACCHINE UTENSILI

Snodato, senza trasformatore



Alimentazione	12 - 24 V 13 W AC/DC
Flusso luminoso	1800 lm
Temperatura colore	6500 K
Numero dei LED	9
Altezza	890 mm
Diametro	125 mm
Snodi	3



0532A/230V € 203,00

LAMPADA A LED PER MACCHINE UTENSILI

Snodato, con trasformatore

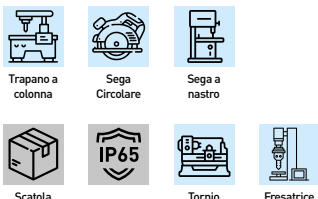

Alimentazione	230 V 50 Hz 13 W
Flusso luminoso	1800 lm
Temperatura colore	6500 K
Numero dei LED	9
Altezza	900 mm
Diametro	125 mm
Snodi	3



0371 € 162,00

LAMPADA A LED PER MACCHINE UTENSILI

Snodato, senza trasformatore



Alimentazione	24V 10W
Flusso luminoso	1200 lm
Temperatura colore	6500 K
Altezza snodo	110 mm
Diametro	110 mm
Snodi	1



0372 € 245,00

LAMPADA A LED PER MACCHINE UTENSILI

Snodato, senza trasformatore

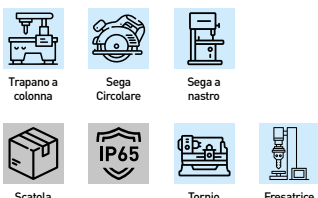

Alimentazione	24V 10W
Flusso luminoso	1200 lm
Temperatura colore	6500 K
Altezza	890 mm
Diametro	110 mm
Snodi	3



0537A € 112,00

LAMPADA A LED PER MACCHINE UTENSILI

Snodato, senza trasformatore.



Alimentazione	12 - 24 V 7 W AC
Flusso luminoso	700 lm
Temperatura colore	6500 K
Numero dei LED	7
Altezza	100 mm
Diametro	90 mm
Snodi	1



0538A

€ 139,00

LAMPADA A LED PER MACCHINE UTENSILI

Snodato, senza trasformatore.



Alimentazione	12 - 24 V 7 W AC
Flusso luminoso	700 lm
Temperatura colore	6500 K
Numero dei LED	7
Altezza	650 mm
Diametro	90 mm
Snodi	3



0536

€ 76,30

LAMPADA ALOGENA PER MACCHINE UTENSILI

Flessibile, con trasformatore e base magnetica



Altezza massima	620 mm
Completa di trasformatore	230 V / 24 V 25 W



0536A

NEW € 142,00

LAMPADA A LED PER MACCHINE UTENSILI



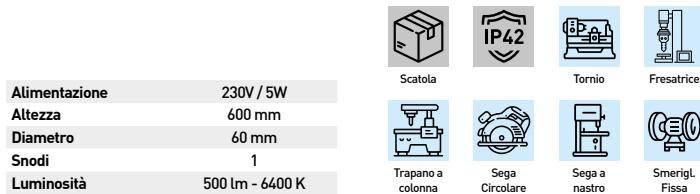



Flessibile, con trasformatore e base magnetica









Alimentazione	230V / 5W
Altezza	600 mm
Diametro	60 mm
Snodi	1
Luminosità	500 lm - 6400 K







 UTENSILI PER TORNITURA E FRESATURA	
p. 132	 Utensili per esterno da tornitura
p. 138	 Utensili per interno da tornitura
p. 142	 Utensili per filettare e troncare
p. 146	 Utensili per fresatura
p. 152	 Accessori utensili

 INSERTI, BRASATI E BARRETTE	
p. 153	 Inserti per tornitura
p. 163	 Inserti per fresatura
p. 166	 Inserti per filettare
p. 166	 Inserti per troncare
p. 167	 Brasati
p. 168	 Barrette

 PUNTE E FRESE DA METALLO	
p. 170	 Punta cilindriche
p. 180	 Punta coniche e da centro
p. 182	 Attacco Weldon
p. 186	 Seghe a tazza
p. 194	 Alesatori a macchina
p. 195	 Lamatori
p. 196	 Svasatori, utensili allargafori e a gradino
p. 198	 Frese frontali
p. 200	 Frese rotative in metallo duro
p. 208	 Coltelli stozzatori e creatori

 PUNTE E FRESE DA EDILIZIA E LEGNO	
p. 209	 Punta cilindriche
p. 209	 Attacco Sds Plus
p. 210	 Seghe a tazza
p. 211	 Utensili diamantati
p. 214	 Punta e seghe a tazza da legno
p. 215	 Frese da legno

 MASCHI E FILIERE	
p. 216	 Maschi e filiere in serie
p. 218	 Maschi a macchina
p. 222	 Filiere e girafiliera

 RIPARAZIONE FILETTI	
p. 223	 Serie riparazione filetti
p. 228	 Inserti filettati
p. 228	 Maschi per riparazione filetti
p. 238	 Utensili per riparazione filetti

 LAME A NASTRO E A DISCO	
p. 240	 Lame a nastro
p. 240	 Lame a disco

IDENTIFICAZIONE UTENSILI PER TORNITURA PER LAVORAZIONE ESTERNA

S	T	G	C	R	16
1	2	3	4	5	6

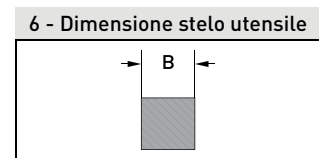
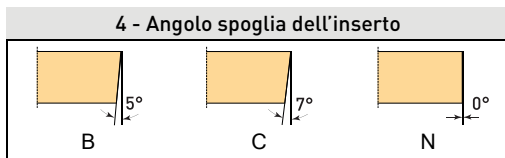
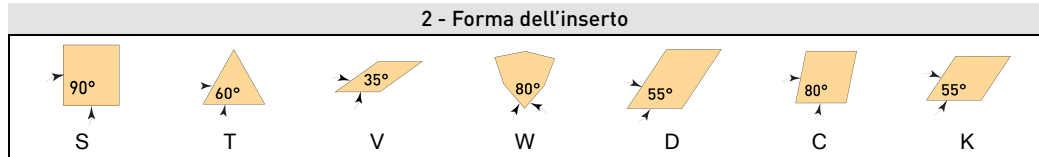
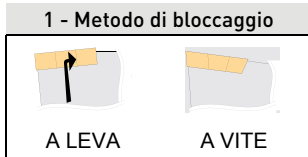
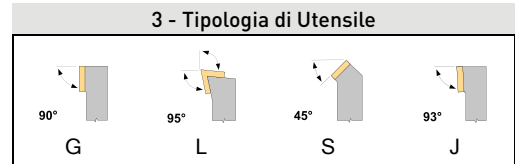

IDENTIFICAZIONE UTENSILI PER TORNITURA PER LAVORAZIONE INTERNA

S	S	S	C	R	16
1	2	3	4	5	6

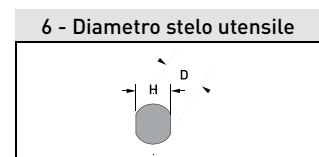
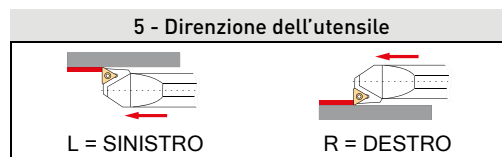
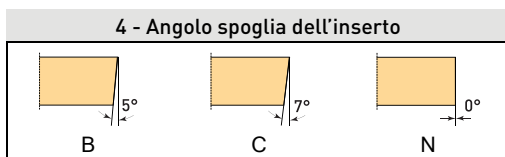
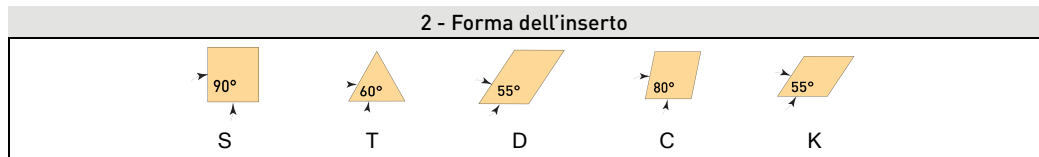
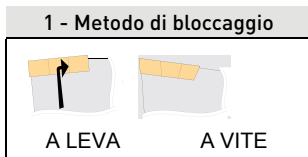
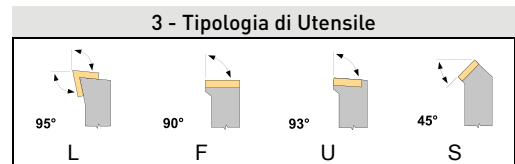

SCELTA DELLA FORMA INSERTO IN BASE AL TIPO DI LAVORAZIONE DA ESEGUIRE

Tornitura esterna	S	T	C	K	D
Tornitura Assiale / Sfacciatura	○	○	●	○	○
Profilatura	-	○	-	○	●
Sfacciatura	●	○	○	○	○
Tornitura a tuffo	-	○	-	-	-

Tornitura interna	S	T	C	K	D
Tornitura Assiale / Sfacciatura	○	●	○	-	○
Profilatura	-	○	-	○	●
Sfacciatura	-	○	●	-	○

Legenda
 ● Forma consigliata
 ○ Forma possibile
 - Non utilizzabile



VALORI CONSIGLIATI VELOCITA' DI TAGLIO Vt (m/min) PER TORNITURA

Materiale da lavorare		Tornitura Esterna		Tornitura Interna		Utensile di Forma	Troncatura	Filettatura con utensile
		Sgrossatura	Finitura	Sgrossatura	Finitura			
P	Acciaio Rm < 600 N/mm ²	100*	150*	70*	100*	50*	95*	25*
	Acc.Rm 600 – 100 N/mm ²	95*	120*	50*	95*	30*	70*	18*
	Acc. Rm 1000 – 1200 N/mm ²	65*	80*	40*	65*	25*	55*	15*
M	Acciaio Inossidabile	60*	70*	35*	60*	20*	50*	15*
K	Ghisa HB < 180	90*	100*	65*	90*	30*	80*	15*
	Ghisa HB > 180	60*	70*	40*	60*	20*	55*	12*
N	Ottone/Bronzo	165*	260*	80*	160*	40*	100*	25*
	Rame	220*	350*	100*	220*	80*	200*	25*
	Alluminio	300*	650*	200*	400*	150*	300*	35*

* = Valori per utensili saldobrasati, per utensili a fissaggio meccanico il valore riportato può essere maggiorato del 15%

VALORI CONSIGLIATI DELL'AVANZAMENTO a (mm/ giro) PER TORNITURA

Materiale da lavorare		Tornitura Esterna		Tornitura Interna		Utensile di Forma	Troncatura
		Sgrossatura	Finitura	Sgrossatura	Finitura		
P	Acciaio Rm < 600 N/mm ²	0.1 – 0.4*	0.05 – 0.2*	0.05 – 0.3*	0.05 – 0.2*	0.02 – 0.05*	0.05 – 0.1*
	Acc.Rm 600 – 100 N/mm ²	0.1 – 0.4*	0.05 – 0.15*	0.05 – 0.3*	0.05 – 0.1*	0.02 – 0.05*	0.05 – 0.1*
	Acc. Rm 1000 – 1200 N/mm ²	0.1 – 0.4*	0.05 – 0.15*	0.05 – 0.3*	0.05 – 0.1*	0.02 – 0.05*	0.05*
M	Acciaio Inossidabile	0.1 – 0.4*	0.05 – 0.15*	0.05 – 0.3*	0.05 – 0.1*	0.02 – 0.05*	0.02 – 0.05*
K	Ghisa HB < 180	0.1 – 0.6*	0.05 – 0.2*	0.05 – 0.6*	0.05 – 0.2*	0.02 – 0.05*	0.05 – 0.1*
	Ghisa HB > 180	0.1 – 0.8*	0.05 – 0.25*	0.05 – 0.5*	0.05 – 0.2*	0.02 – 0.05*	0.02 – 0.05*
N	Ottone/Bronzo	0.1 – 0.8*	0.05 – 0.25*	0.05 – 0.6*	0.05 – 0.2*	0.02 – 0.1*	0.05 – 0.2*
	Rame	0.1 – 0.6*	0.05 – 0.25*	0.05 – 0.5*	0.05 – 0.25*	0.02 – 0.05*	0.05 – 0.1*
	Alluminio	0.1 – 0.8*	0.05 – 0.25*	0.05 – 0.4*	0.05 – 0.2*	0.02 – 0.2*	0.05 – 0.3*

* = Valori per utensili saldobrasati, per utensili a fissaggio meccanico il valore riportato può essere maggiorato del 15%

VALORI CONSIGLIATI DELL'AVANZAMENTO a (mm/ giro) PER TORNITURA

Profondità di passata		Ø particolare					
Sgrossatura	0.5 - 10	fino a 25	25 - 70	50 - 75	75 - 100	100 - 150	150 - 300
Finitura	0.2 - 20						
Troncatura	Pari allo spessore dell'inserto troncatore						

PRINCIPALI FORMULE TORNITURA

- $V_t = (n \times \pi \times D) \div 1000$
- $n = (V_t \times 1000) \div (\pi \times D)$
- $V_f = n \times F_z$

Legenda

Vt : Velocità di taglio in metri al minuto. E' la velocità periferica con cui il tagliente asporta il materiale. (m/min)
n : Velocità di rotazione del mandrino in giri al minuto (gir/min)
D : Diametro del pezzo da lavorare in millimetri (mm)
Fz : Avanzamento dell'utensile (per dente) ad ogni giro in millimetri (mm/giro)
Vf : Velocità di avanzamento dell'utensile in millimetri al minuto (mm/min)
 π : il suo valore è di 3.14

TIPOLOGIA UTENSILI PER TORNITURA ESTERNA

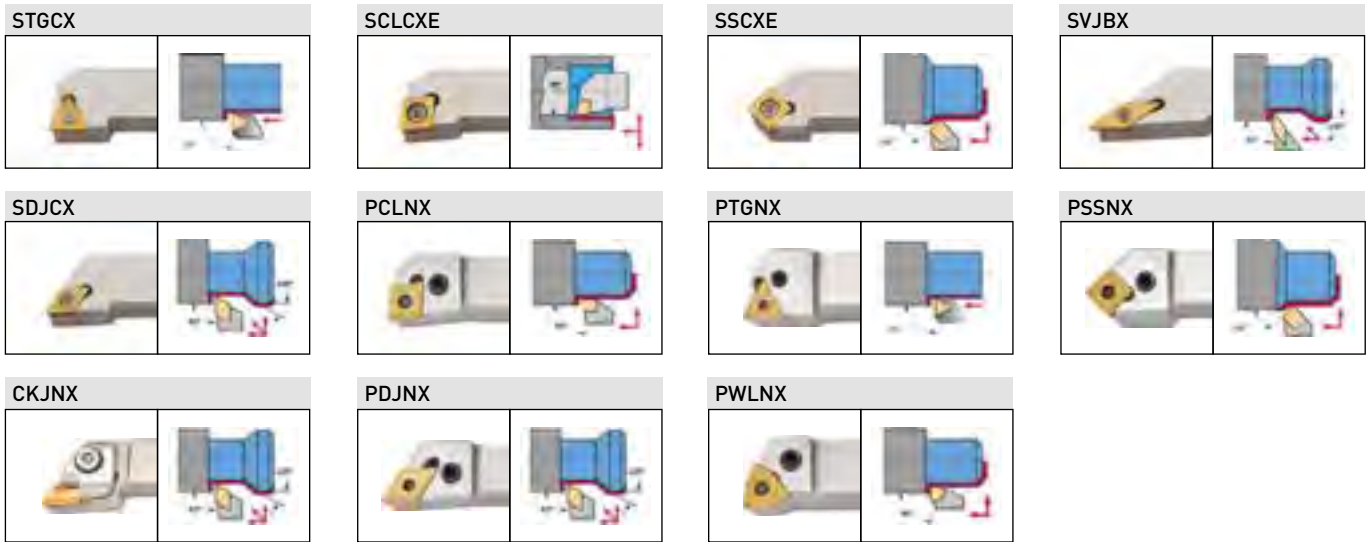

TIPOLOGIA UTENSILI PER TORNITURA INTERNA

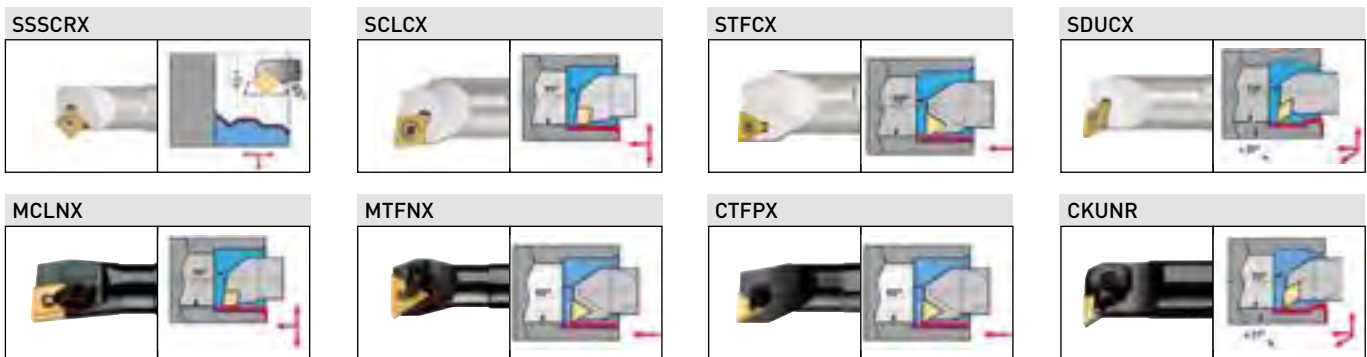

TIPOLOGIA UTENSILI PER FILETTATURA

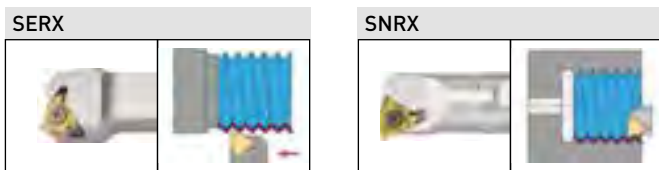

TIPOLOGIA UTENSILI PER ESECUZIONE GOLE E TRONCATURA

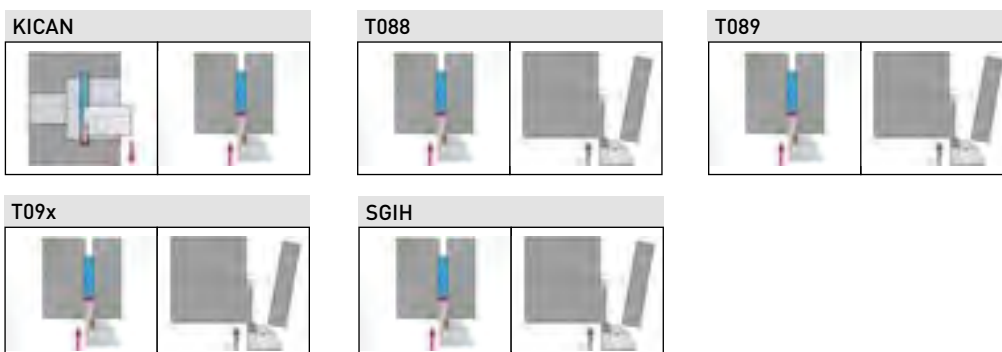



B007-

SET 5 UTENSILI AD INSERTO

Inserti inclusi, Utile per avere un set che permette di eseguire la maggior parte di operazioni di tornitura con torni di piccole dimensioni

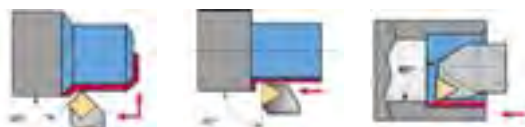

Art.	€	Stelo ut. est. / Inserto	Stelo ut. int. / Inserto	Vite
B007/10	€ 108,00	10 mm / TCMT110204N	8 mm / TCMT090204N	KV200
B007/12	€ 114,00	12 mm / TCMT110204N	10 mm / TCMT110204N	KV250
B007/16	€ 141,00	16 mm / TCMT16T304N	12 mm / TCMT110204N	KV250

KITCKJ

UTENSILE PER ESTERNO CON INSERTI

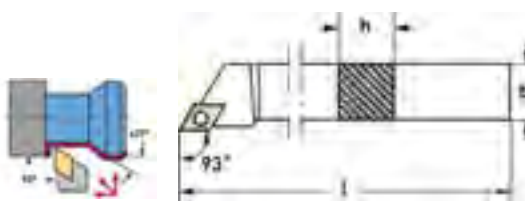

Art.	€	Utensili per esterno	Inserti	b	h	l
KITCKJ20	€ 170,00	CKJNR20	KNUX160405RN x 10 Pz	20mm	20mm	125mm
KITCKJ25	€ 172,00	CKJNR25	KNUX160405RN x 10 Pz	25mm	25mm	150mm

STGCX

UTENSILE PER ESTERNO 90°

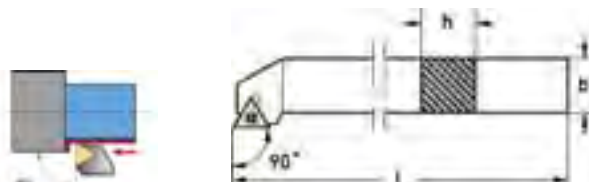
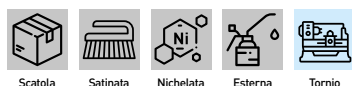

Art.	€	Lato	b	h	l	Vite	Bussola	Base	Inserto (non incluso)
STGCR16/11	€ 43,80	Dx/R	16 mm	16 mm	100 mm	KV250	-----	-----	TCMT1102...
STGCL16/11	€ 43,80	Sx/L	16 mm	16 mm	100 mm	KV250	-----	-----	TCMT1102...
STGCR20	€ 49,50	Dx/R	20 mm	20 mm	125 mm	KV350	BU3550	BSTG16	TCMT16T3...
STGCL20	€ 49,50	Sx/L	20 mm	20 mm	125 mm	KV350	BU3550	BSTG16	TCMT16T3...
STGCR25	€ 60,80	Dx/R	25 mm	25 mm	150 mm	KV350	BU3550	BSTG16	TCMT16T3...
STGCL25	€ 60,80	Sx/L	25 mm	25 mm	150 mm	KV350	BU3550	BSTG16	TCMT16T3...

SCLCXE

UTENSILE PER ESTERNO 95°

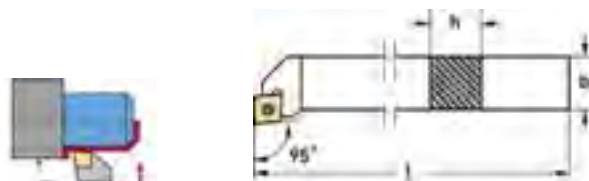
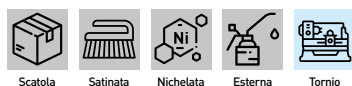

Art.	€	Lato	b	h	l	Vite	Bussola	Base	Inserto (non incluso)
SCLCR12E	€ 37,50	Dx/R	12 mm	12 mm	80 mm	KV350	-----	-----	CCMT09T3...
SCLCL12E	€ 37,50	Sx/L	12 mm	12 mm	80 mm	KV350	-----	-----	CCMT09T3...
SCLCR16E	€ 45,30	Dx/R	16 mm	16 mm	100 mm	KV350	BU3550	BSCL09	CCMT09T3...
SCLCL16E	€ 45,30	Sx/L	16 mm	16 mm	100 mm	KV350	BU3550	BSCL09	CCMT09T3...
SCLCR20E	€ 50,70	Dx/R	20 mm	20 mm	125 mm	KV450	BU4560	BSCL12	CCMT1204...
SCLCL20E	€ 50,70	Sx/L	20 mm	20 mm	125 mm	KV450	BU4560	BSCL12	CCMT1204...
SCLCR25E	€ 60,80	Dx/R	25 mm	25 mm	150 mm	KV450	BU4560	BSCL12	CCMT1204...
SCLCL25E	€ 60,80	Sx/L	25 mm	25 mm	150 mm	KV450	BU4560	BSCL12	CCMT1204...

SSSCXE

UTENSILE PER ESTERNO 45°

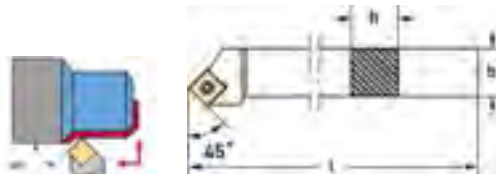
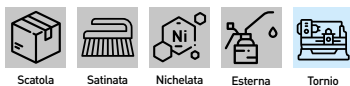

Art.	€	Lato	b	h	l	Vite	Bussola	Base	Inserto (non incluso)
SSSCR20E	€ 49,50	Dx/R	20 mm	20 mm	125 mm	KV400	BU4560	BSSS12	SCMT1204...
SSSCL20E	€ 49,50	Sx/L	20 mm	20 mm	125 mm	KV400	BU4560	BSSS12	SCMT1204...
SSSCR25E	€ 63,80	Dx/R	25 mm	25 mm	150 mm	KV450	BU4560	BSSS12	SCMT1204...
SSSCL25E	€ 63,80	Sx/L	25 mm	25 mm	150 mm	KV450	BU4560	BSSS12	SCMT1204...

SVJBX

UTENSILE PER ESTERNO 93°



Art.	€	Lato	b	h	l	Vite	Bussola	Base	Inserto (non incluso)
SVJBR20	€ 49,50	Dx/R	20 mm	20 mm	125 mm	KV350	BU3550	BSVJ16	VBMT1604...
SVJBL20	€ 49,50	Sx/L	20 mm	20 mm	125 mm	KV350	BU3550	BSVJ16	VBMT1604...
SVJBR25	€ 63,80	Dx/R	25 mm	25 mm	150 mm	KV350	BU3550	BSVJ16	VBMT1604...
SVJBL25	€ 63,80	Sx/L	25 mm	25 mm	150 mm	KV350	BU3550	BSVJ16	VBMT1604...

SDJCX

UTENSILE PER ESTERNO 93°

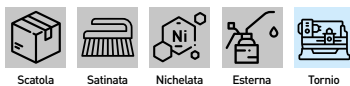

Art.	€	Lato	b	h	l	Vite	Bussola	Base	Inserto (non incluso)
SDJCR10	€ 28,50	Dx/R	10 mm	10 mm	70 mm	KV250	-----	-----	DCMT0702...
SDJCR12	€ 41,00	Dx/R	12 mm	12 mm	80 mm	KV250	-----	-----	DCMT0702...
SDJCR16	€ 47,20	Dx/R	16 mm	16 mm	100 mm	KV250	-----	-----	DCMT0702...
SDJCR20	€ 53,40	Dx/R	20 mm	20 mm	125 mm	KV350	BU3550	BSDJ11	DCMT11T3...
SDJCL20	€ 53,40	Sx/L	20 mm	20 mm	125 mm	KV350	BU3550	BSDJ11	DCMT11T3...
SDJCR25	€ 67,70	Dx/R	25 mm	25 mm	150 mm	KV350	BU3550	BSDJ11	DCMT11T3...
SDJCL25	€ 67,70	Sx/L	25 mm	25 mm	150 mm	KV350	BU3550	BSDJ11	DCMT11T3...

PCLNX

UTENSILE PER ESTERNO 95°

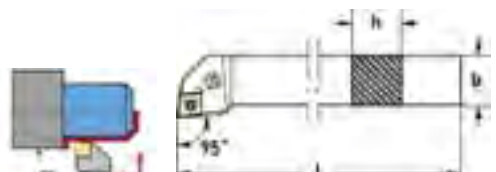
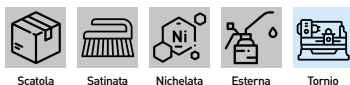

Art.	€	Lato	b	h	l	Ricambi	Inserto (non incluso)
PCLNR16	€ 41,10	Dx/R	16 mm	16 mm	100 mm	RICAPCLN	CNMG1204...
PCLNR20	€ 53,80	Dx/R	20 mm	20 mm	125 mm	RICAPCLN	CNMG1204...
PCLNL20	€ 53,80	Sx/L	20 mm	20 mm	125 mm	RICAPCLN	CNMG1204...
PCLNR25	€ 63,80	Dx/R	25 mm	25 mm	150 mm	RICAPCLN	CNMG1204...
PCLNL25	€ 63,80	Sx/L	25 mm	25 mm	150 mm	RICAPCLN	CNMG1204...



PTGNX

UTENSILE PER ESTERNO 90°

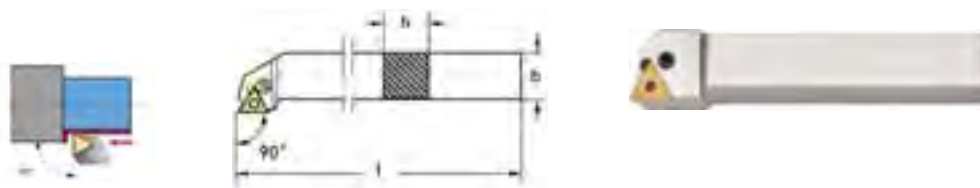
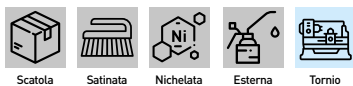

Art.	€	Lato	b	l	h	Ricambi	Inserto (non incluso)
PTGNR16	€ 41,10	Dx/R	16 mm	16 mm	100 mm	RICAPTGN	TNMG1604...
PTGNR20	€ 50,20	Dx/R	20 mm	20 mm	125 mm	RICAPTGN	TNMG1604...
PTGNL20	€ 50,20	Sx/L	20 mm	20 mm	125 mm	RICAPTGN	TNMG1604...
PTGNR25	€ 63,80	Dx/R	25 mm	25 mm	150 mm	RICAPTGN	TNMG1604...
PTGNL25	€ 63,80	Sx/L	25 mm	25 mm	150 mm	RICAPTGN	TNMG1604...

PSSNX

UTENSILE PER ESTERNO 45°

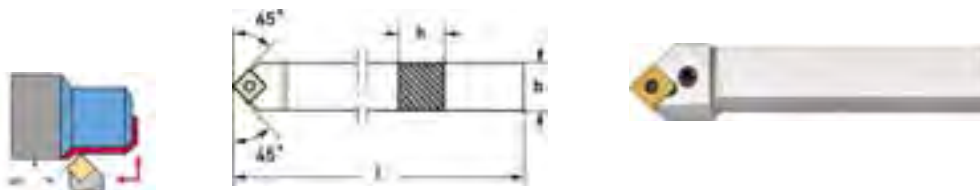
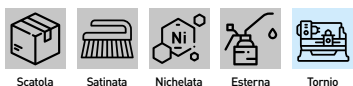

Art.	€	Lato	b	h	l	Ricambi	Inserto (non incluso)
PSSNR16	€ 41,10	Dx/R	16 mm	16 mm	100 mm	RICAPSSN	SNMG1204...
PSSNR20	€ 50,70	Dx/R	20 mm	20 mm	125 mm	RICAPSSN	SNMG1204...
PSSNL20	€ 50,70	Sx/L	20 mm	20 mm	125 mm	RICAPSSN	SNMG1204...
PSSNR25	€ 63,80	Dx/R	25 mm	25 mm	150 mm	RICAPSSN	SNMG1204...
PSSNL25	€ 63,80	Sx/L	25 mm	25 mm	150 mm	RICAPSSN	SNMG1204...

CKJNX

UTENSILE PER ESTERNO 93°

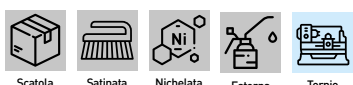

Art.	€	Lato	b	h	l	Staffa	Vite	Base	Inserto (non incluso)
CKJNL20	€ 60,80	Sx/L	20 mm	20 mm	125 mm	STAFCKJNL	VITECKJN	BASECKJNL	KNUX160405L...
CKJNL25	€ 70,60	Sx/L	25 mm	25 mm	150 mm	STAFCKJNL	VITECKJN	BASECKJNL	KNUX160405L...
CKJNR16	€ 50,20	Dx/R	20 mm	16 mm	100 mm	STAFCKJNR	VITECKJN	BASECKJNR	KNUX160405R...
CKJNR20	€ 60,80	Dx/R	20 mm	20 mm	125 mm	STAFCKJNR	VITECKJN	BASECKJNR	KNUX160405R...
CKJNR25	€ 70,60	Dx/R	25 mm	25 mm	150 mm	STAFCKJNR	VITECKJN	BASECKJNR	KNUX160405R...

PDJNX

UTENSILE PER ESTERNO 93°

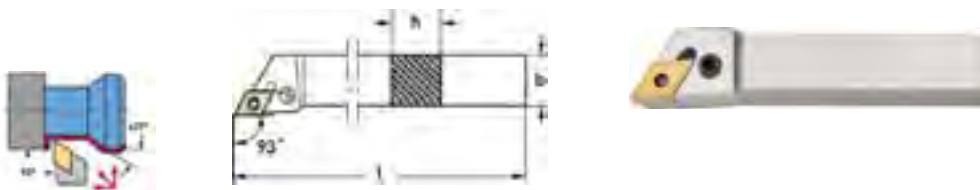
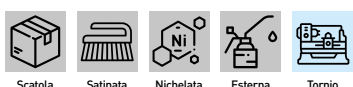

Art.	€	Lato	b	l	h	Ricambi	Inserto (non incluso)
PDJNR20	€ 52,00	Dx/R	20 mm	20 mm	125 mm	PDJNRKIT	DNMG1506...
PDJNR25	€ 63,80	Dx/R	25 mm	25 mm	150 mm	PDJNRKIT	DNMG1506...
PDJNL25	€ 63,80	Sx/L	25 mm	25 mm	150 mm	PDJNRKIT	DNMG1506...

PWLNK

UTENSILE PER ESTERNO 95°

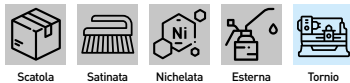

Art.	€	Lato	b	h	l	Ricambi	Inserto (non incluso)
PWLNK20	€ 52,00	Dx/R	20 mm	20 mm	125 mm	PWLNKKIT	WNMG0804...
PWLNK25	€ 63,80	Dx/R	25 mm	25 mm	150 mm	PWLNKKIT	WNMG0804...
PWLNK25	€ 63,80	Sx/L	25 mm	25 mm	150 mm	PWLNKKIT	WNMG0804...

G007-

PORTA GODRONI COMPLETO DI N° 3 COPPIE DI GODRONI, TAGLIO A DIAMANTE

A forma di rombo 45° per l'esecuzione di zigrinature per deformazione in tornitura. Dotato di 2 ruote di ricambio passo 0.8mm



Art.	€	Stelo	Passo
G007/16	€ 73,00	16 mm	0,8 - 1,2 - 1,8 mm
G007/20	€ 74,10	20 mm	0,8 - 1,2 - 1,8 mm

KISCLCR

€ 227,00

SET UTENSILI PER INTERNO 95°



Utensili per interno	SCLCR08; SCLCR10; SCLCR12; SCLCR16
Inserti	CCMT060204N x 10 Pz
Chiave torx	T7 x 2 Pz
Vite	T7 x 2,5 mm x 4 Pz

KISTCMT

€ 268,00

SET UTENSILI PER INTERNO 90°



Utensili per interno	STFCR08; STFCR10; STFCR12; STFCR16; STFCR20
Inserti	TCMT110204N x 10 Pz
Chiave torx	T8 x 2 Pz
Vite	T8 x 2,5 mm x 5 Pz



KISTFCR

€ 211,00

SET UTENSILI PER INTERNO BLOCCAGGIO A VITE 90°



Utensili per interno	STFCR08, STFCR10, STFCR12, STFCR16, STFCR20
Inserto (non incluso)	TCMT110204...
Chiave torx	T8 x 2 Pz
Vite	T8 x 2,5 mm x 5 Pz



SSSCRX

UTENSILI PER INTERNO 45°

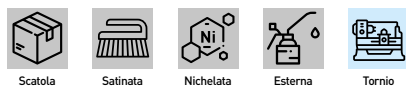
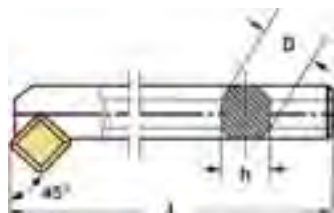
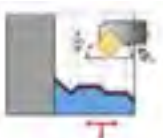

Art.	€	D	h	l	Vite	Inserto (non incluso)
SSSCR16	€ 48,70	16 mm	15 mm	200 mm	KV400	SCMT09T3...
SSSCR20	€ 54,20	20 mm	18 mm	250 mm	KV400	SCMT09T3...
SSSCR25	€ 63,80	25 mm	22.5 mm	300 mm	KV400	SCMT09T3...

SCLCX

UTENSILE PER INTERNO 95°

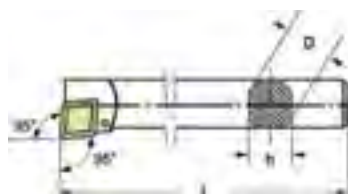

Art.	€	Lato	D	h	l	Vite	Inserto (non incluso)
SCLCR08	€ 57,70	Dx/R	8 mm	7 mm	125 mm	KV250	CCMT0602...
SCLCL08	€ 57,70	Sx/L	8 mm	7 mm	125 mm	KV250	CCMT0602...
SCLCR10	€ 57,70	Dx/R	10 mm	9 mm	140 mm	KV250	CCMT0602...
SCLCL10	€ 57,70	Sx/L	10 mm	9 mm	140 mm	KV250	CCMT0602...
SCLCR12	€ 57,70	Dx/R	12 mm	11 mm	160 mm	KV250	CCMT0602...
SCLCL12	€ 57,70	Sx/L	12 mm	11 mm	160 mm	KV250	CCMT0602...
SCLCR16	€ 65,40	Dx/R	16 mm	14,5 mm	180 mm	KV400	CCMT09T3...
SCLCL16	€ 65,40	Sx/L	16 mm	14,5 mm	180 mm	KV400	CCMT09T3...
SCLCR20	€ 65,40	Dx/R	20 mm	18 mm	200 mm	KV400	CCMT09T3...
SCLCL20	€ 65,40	Sx/L	20 mm	18 mm	200 mm	KV400	CCMT09T3...
SCLCR25	€ 73,00	Dx/R	25 mm	22,5 mm	250 mm	KV400	CCMT09T3...
SCLCL25	€ 73,00	Sx/L	25 mm	22,5 mm	250 mm	KV400	CCMT09T3...
SCLCR32	€ 103,00	Dx/R	32 mm	29 mm	300 mm	KV400	CCMT09T3...
SCLCL32	€ 103,00	Sx/L	32 mm	29 mm	300 mm	KV400	CCMT09T3...

STFCX
UTENSILE PER INTERNO 90°

Art.	€	Lato	D	h	l	Vite	Inserto (non incluso)
STFCR08	€ 57,70	Dx/R	8 mm	7 mm	125 mm	KV250	TCMT1102...
STFCL08	€ 57,70	Sx/L	8 mm	7 mm	125 mm	KV250	TCMT1102...
STFCR10	€ 57,70	Dx/R	10 mm	9 mm	150 mm	KV250	TCMT1102...
STFCL10	€ 57,70	Sx/L	10 mm	9 mm	150 mm	KV250	TCMT1102...
STFCR12	€ 57,70	Dx/R	12 mm	11 mm	150 mm	KV250	TCMT1102...
STFCL12	€ 57,70	Sx/L	12 mm	11 mm	150 mm	KV250	TCMT1102...
STFCR16	€ 65,40	Dx/R	16 mm	14,5 mm	200 mm	KV250	TCMT1102...
STFCL16	€ 65,40	Sx/L	16 mm	14,5 mm	200 mm	KV250	TCMT1102...
STFCR20	€ 65,40	Dx/R	20 mm	18,5 mm	250 mm	KV250	TCMT1102...
STFCL20	€ 65,40	Sx/L	20 mm	18,5 mm	250 mm	KV250	TCMT1102...
STFCR25	€ 73,00	Dx/R	25 mm	22,5 mm	250 mm	KV350	TCMT16T3...
STFCL25	€ 73,00	Sx/L	25 mm	22,5 mm	250 mm	KV350	TCMT16T3...
STFCR32	€ 103,00	Dx/R	32 mm	29 mm	300 mm	KV350	TCMT16T3...
STFCL32	€ 103,00	Sx/L	32 mm	29 mm	300 mm	KV350	TCMT16T3...

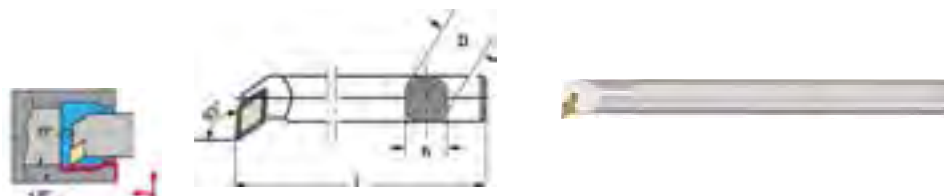
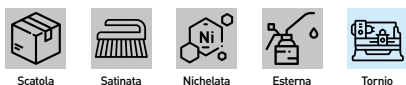
SDUCX
UTENSILE PER INTERNO 93°

Art.	€	Lato	D	h	l	Vite	Inserto (non incluso)
SDUCR10	€ 57,70	Dx/R	10 mm	9 mm	140 mm	KV250	DCMT0702...
SDUCL10	€ 57,70	Sx/L	10 mm	9 mm	140 mm	KV250	DCMT0702...
SDUCR12	€ 57,70	Dx/R	12 mm	11 mm	160 mm	KV250	DCMT0702...
SDUCL12	€ 57,70	Sx/L	12 mm	11 mm	160 mm	KV250	DCMT0702...
SDUCR16	€ 65,40	Dx/R	16 mm	15 mm	180 mm	KV250	DCMT0702...
SDUCL16	€ 65,40	Sx/L	16 mm	15 mm	180 mm	KV250	DCMT0702...
SDUCR20	€ 65,40	Dx/R	20 mm	18 mm	200 mm	KV350	DCMT11T3...
SDUCL20	€ 65,40	Sx/L	20 mm	18 mm	200 mm	KV350	DCMT11T3...
SDUCR25	€ 73,00	Dx/R	25 mm	23 mm	250 mm	KV350	DCMT11T3...
SDUCL25	€ 73,00	Sx/L	25 mm	23 mm	250 mm	KV350	DCMT11T3...
SDUCR32	€ 103,00	Dx/R	32 mm	30 mm	300 mm	KV350	DCMT11T3...
SDUCL32	€ 103,00	Sx/L	32 mm	30 mm	300 mm	KV350	DCMT11T3...

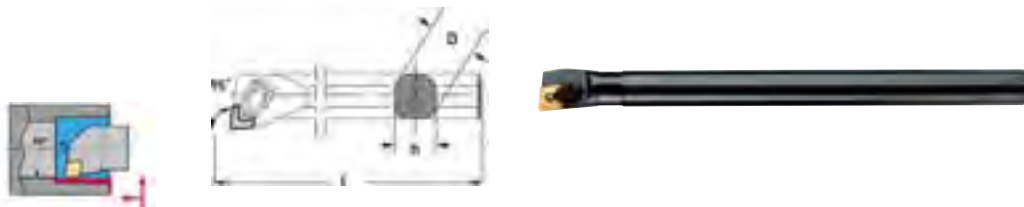
MCLNX
UTENSILE PER INTERNO 95°

Art.	€	Lato	D	h	l	Staffa	Base	Inserto (non incluso)
MCLNR16	€ 75,10	Dx/R	16 mm	15 mm	210 mm	CTMTMC16/20	-----	CNMG1204...
MCLNL16	€ 75,10	Sx/L	16 mm	15 mm	210 mm	CTMTMC16/20	-----	CNMG1204...
MCLNR20	€ 82,80	Dx/R	20 mm	18 mm	255 mm	CTMTMC16/20	-----	CNMG1204...
MCLNL20	€ 82,80	Sx/L	20 mm	18 mm	255 mm	CTMTMC16/20	-----	CNMG1204...
MCLNR25	€ 105,00	Dx/R	25 mm	23 mm	300 mm	CTMTMC25/32	MCLNBASE25/32	CNMG1204...
MCLNL25	€ 105,00	Sx/L	25 mm	23 mm	300 mm	CTMTMC25/32	MCLNBASE25/32	CNMG1204...
MCLNR32	€ 128,00	Dx/R	32 mm	30 mm	355 mm	CTMTMC25/32	MCLNBASE25/32	CNMG1204...
MCLNL32	€ 128,00	Sx/L	32 mm	30 mm	355 mm	CTMTMC25/32	MCLNBASE25/32	CNMG1204...



MTFNX

UTENSILE PER INTERNO 90°

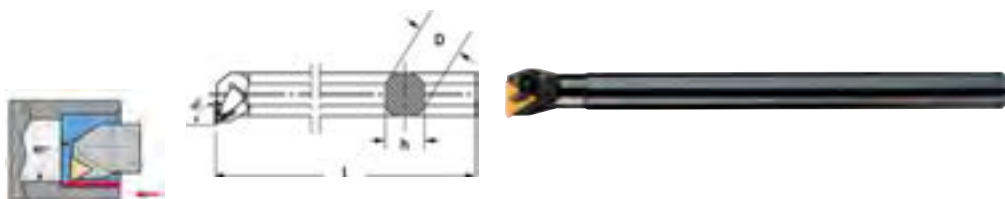

Art.	€	Lato	D	h	l	Staffa	Base	Inserito (non incluso)
MTFNR16	€ 74,10	Dx/R	16 mm	15 mm	210 mm	CTMTMC16/20	-----	TNMG1604...
MTFNL16	€ 74,10	Sx/L	16 mm	15 mm	210 mm	CTMTMC16/20	-----	TNMG1604...
MTFNR20	€ 82,80	Dx/R	20 mm	18 mm	255 mm	CTMTMC16/20	-----	TNMG1604...
MTFNL20	€ 82,80	Sx/L	20 mm	18 mm	255 mm	CTMTMC16/20	-----	TNMG1604...
MTFNR25	€ 105,00	Dx/R	25 mm	23 mm	300 mm	CTMTMC25/32	MTFNBASE25/32	TNMG1604...
MTFNL25	€ 105,00	Sx/L	25 mm	23 mm	300 mm	CTMTMC25/32	MTFNBASE25/32	TNMG1604...
MTFNR32	€ 128,00	Dx/R	32 mm	30 mm	355 mm	CTMTMC25/32	MTFNBASE25/32	TNMG1604...
MTFNL32	€ 128,00	Sx/L	32 mm	30 mm	355 mm	CTMTMC25/32	MTFNBASE25/32	TNMG1604...

CTFPX

UTENSILE PER INTERNO 90°

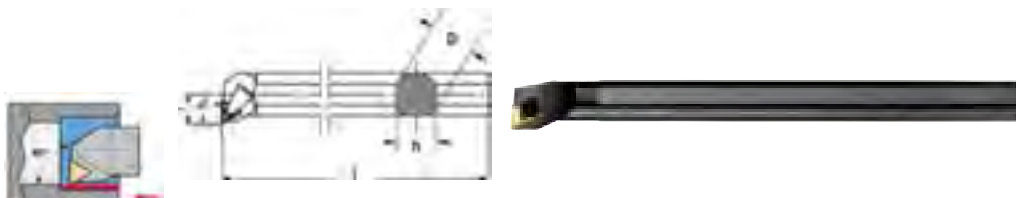

Art.	€	Lato	D	h	l	Staffa	Base	Inserito (non incluso)
CTFPR10	€ 63,20	Dx/R	10 mm	9 mm	150 mm	CTFP10/12	-----	TPMR0902...
CTFPL10	€ 63,20	Sx/L	10 mm	9 mm	150 mm	CTFP10/12	-----	TPMR0902...
CTFPR12	€ 63,20	Dx/R	12 mm	11 mm	150 mm	CTFP10/12	-----	TPMR1103...
CTFPL12	€ 63,20	Sx/L	12 mm	11 mm	150 mm	CTFP10/12	-----	TPMR1103...
CTFPR16	€ 73,00	Dx/R	16 mm	15 mm	210 mm	CTMTMC16/20	-----	TPMR1103...
CTFPL16	€ 73,00	Sx/L	16 mm	15 mm	210 mm	CTMTMC16/20	-----	TPMR1103...
CTFPR20	€ 82,80	Dx/R	20 mm	18 mm	255 mm	CTMTMC16/20	-----	TPMR1603...
CTFPL20	€ 82,80	Sx/L	20 mm	18 mm	255 mm	CTMTMC16/20	-----	TPMR1603...
CTFPR25	€ 102,00	Dx/R	25 mm	23 mm	300 mm	CTMTMC25/32	CTFPBASE25/32	TPMR1603...
CTFPL25	€ 102,00	Sx/L	25 mm	23 mm	300 mm	CTMTMC25/32	CTFPBASE25/32	TPMR1603...
CTFPR32	€ 128,00	Dx/R	32 mm	30 mm	355 mm	CTMTMC25/32	CTFPBASE25/32	TPMR1603...
CTFPL32	€ 128,00	Sx/L	32 mm	30 mm	355 mm	CTMTMC25/32	CTFPBASE25/32	TPMR1603...

CKUNR

UTENSILE PER INTERNO 93°

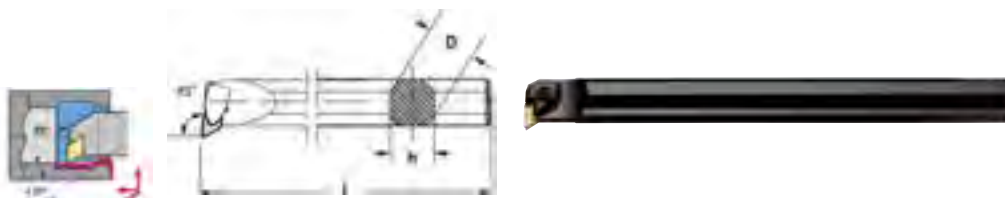

Art.	€	Lato	D	h	l	Staffa	Vite	Base	Inserito (non incluso)
CKUNR25	€ 167,00	Dx/R	25 mm	23 mm	300 mm	STAFCKJNR	VITECKJN	BASECKJNR	KNUX1604...
CKUNR32	€ 190,00	Dx/R	32 mm	30 mm	350 mm	STAFCKJNR	VITECKJN	BASECKJNR	KNUX1604...
CKUNR40	€ 200,00	Dx/R	40 mm	37 mm	400 mm	STAFCKJNR	VITECKJN	BASECKJNR	KNUX1604...

KISER

KIT FILETTATURA PER ESTERNO

Composto dall'utensile per filettatura esterna (1 Pz), vite di ricambio M3.5 X 12mm (1 Pz), chiave esagonale 2,5mm (1 Pz), chiave torx T15 (1 Pz) ed inserti assortiti: AG55 - AG60; - ISO 0,8 - 1,00 - 1,25 - 1,50 - 1,75 - 2,00 - 2,50 - 3,00mm (1 Pz ciascuno).

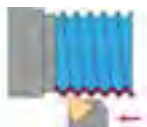

Art.	€	Utensili per esterno	Inserto	Chiave torx	Vite	b	l	h
KISER	€ 179,00	SER20	16ER...	T15	M3,5 x 12 mm	20 mm	20 mm	125 mm
KISER25	€ 235,00	SER25	16ER...	T15	M3,5 x 12 mm	25 mm	25 mm	150 mm

KISNR

KIT FILETTATURA PER INTERNO

Composto dall'utensile per filettatura interna (1 Pz), vite di ricambio M3.5 X 12mm (1 Pz), chiave esagonale 2,5mm (1 Pz), chiave torx T15 (1 Pz) ed inserti assortiti: AG55 - AG60; - ISO 0,8 - 1,00 - 1,25 - 1,50 - 1,75 - 2,00 - 2,50 - 3,00mm (1 Pz ciascuno).

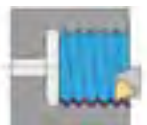

Art.	€	Utensili per interno	Inserto	Chiave torx	Vite	D	h	l
KISNR	€ 206,00	SNR20	16IR...	T15	M3.5 x 12 mm	20 mm	18 mm	170 mm
KISNR25	€ 246,00	SNR25	16IR...	T15	M3.5 x 12 mm	25 mm	23 mm	200 mm

KICAN

€ 230,00

SET PER CANALINI ESTERNI ED INTERNI

Composto dall'utensile per canalini esterni: 20 x 20 mm (1 Pz), l'utensile per canalini interni: ø 20mm (1 Pz), vite di ricambio M4 x 12mm (2 Pz), chiave torx: T15 (1 Pz) ed inserti per scanalatura 16mm rivestiti al TIN: 165110134 (2 Pz), 165130134 (2 Pz), 165160134 (2 Pz), 165185134 (1 Pz), 165215134 (1 Pz), 165265134 (1 Pz), 165315134 (1 Pz).





SERX

UTENSILE FILETTARE ESTERNO FISSAGGIO A VITE

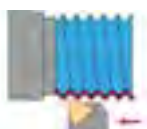
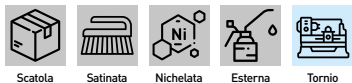

Art.	€	b	h	l	Base	Bussola	Vite	Inserito (non incluso)
SER16	€ 54,80	16 mm	16 mm	100 mm	-----	-----	KV350	16ER..
SER20	€ 70,40	20 mm	20 mm	125 mm	BSER16	BU3550	KV350	16ER...
SER25	€ 81,30	25 mm	25 mm	150 mm	BSER16	BU3550	KV350	16ER...

SNRX

UTENSILE FILETTARE INTERNO FISSAGGIO A VITE

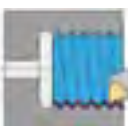
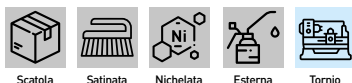

Art.	€	D	h	l	Base	Vite	Bussola	Inserito (non incluso)
SNR12	€ 54,80	12 mm	11 mm	150 mm	-----	KV250	-----	11IR...
SNR16	€ 63,90	16 mm	15 mm	170 mm	-----	KV350	-----	16IR...
SNR20	€ 77,40	20 mm	18 mm	200 mm	BSNR16	KV350	BU3550	16IR...
SNR25	€ 95,90	25 mm	23 mm	300 mm	BSNR16	KV350	BU3550	16IR...

T088

€ 99,00

SET DA TAGLIO

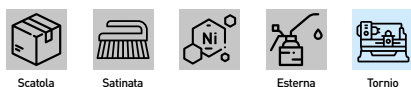
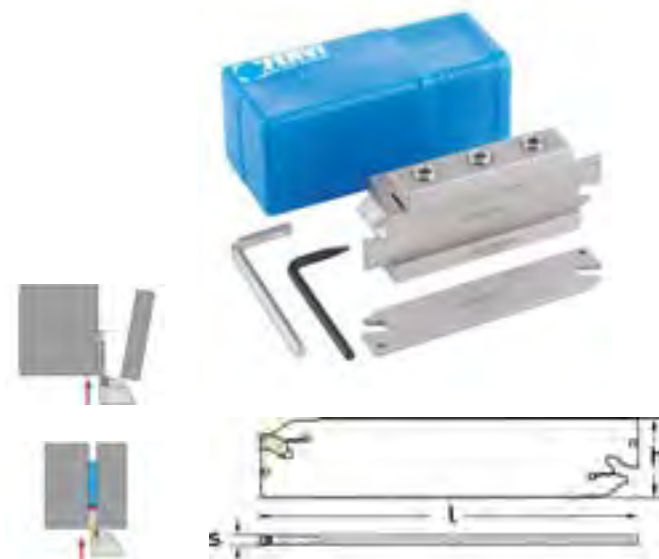

Contenuto del set	1 Pz SGTBK16 - 1 Pz SGIH26/2 - 1 Pz SGIH26/3
S	2 - 3 mm
h	25.75 mm
l	109 mm
Inserito (non incluso)	GCMX2N - GCMX3N

T089

€ 69,30

SET DA TAGLIO

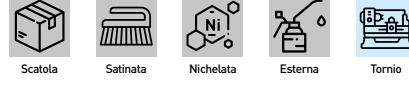
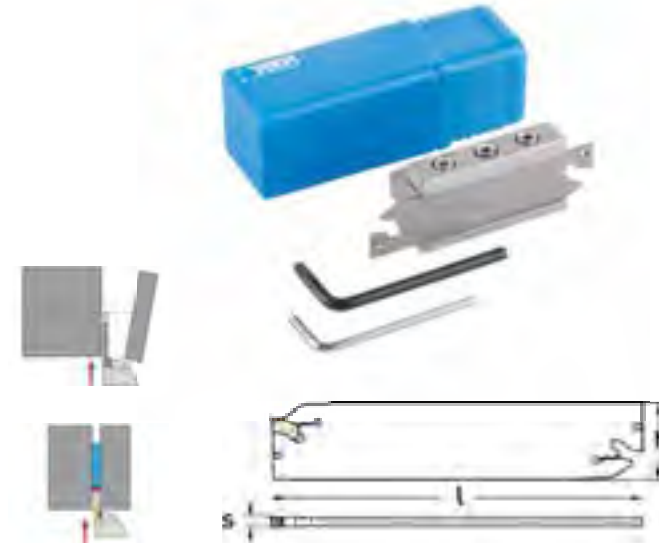

Contenuto del set	1 Pz SGIH19/2 - 1 Pz SGTBK10
S	2 mm
h	19.5 mm
l	85 mm
Inserito (non incluso)	GCMX2N

T09X

SET DA TAGLIO



Art.	€	Contenuto del set	S	h	l	Inserito (non incluso)
T090	€ 163,00	1 Pz SGIH32/3 - 1 Pz SGIH32/4 - 1 Pz SGIH32/5 - 1 Pz SGTBK25	3 - 4 - 5 mm	31,75 mm	150 - 160 mm	GCMX3N - GCMX4N - GCMX5N
T091	€ 119,00	1 Pz SGIH26/2 - 1 Pz SGIH26/3 - 1 Pz SGTBK20	2 - 3 mm	25,75 mm	109 mm	GCMX2N - GCMX3N

SGIH

UTENSILE PER TAGLIO ESTERNO - LAMA



Art.	€	S	h	l	Inserito (non incluso)
SGIH26/2	€ 33,00	2 mm	25.75 mm	109 mm	GCMX2N...
SGIH26/3	€ 33,00	3 mm	25.75 mm	109 mm	GCMX3N...
SGIH32/3	€ 33,00	3 mm	31.75 mm	150 mm	GCMX3N...
SGIH32/4	€ 33,00	4 mm	31 mm	150 mm	GCMX4N...
SGIH32/5	€ 33,00	5 mm	31.75 mm	150 mm	GCMX5N...
SGIH19/2	€ 26,50	2 mm	19.5 mm	85 mm	GCMX2N...

SGTBK

UTENSILE PER TAGLIO ESTERNO - BLOCCO PORTA LAMA



Art.	€	Stelo	Dimensioni	Lama
SGTBK10	€ 43,80	10 x 10 mm	56 x 25 x 30 mm	19 mm
SGTBK16	€ 47,50	16 x 16 mm	87 x 38 x 33 mm	26 mm
SGTBK20	€ 52,30	20 x 20 mm	100 x 38 x 45h mm	26 mm
SGTBK25	€ 65,30	25 x 25 mm	110 x 49 x 48h mm	32 mm



TIPOLOGIA UTENSILI FRESATURA FERVI

Fresatura di spallamenti

Fresatura che genera 2 facce contemporaneamente ottenendo uno spallamento di 90°

Spianatura

Fresatura che permette di rendere piana una superficie grezza

Fresatura ad alti avanzamenti

Fresatura di spianatura con utensili che permettono alte velocità di avanzamento (fino a 4mm/dente)

Copiatura

Combinazione di fresatura discorde e concorde, richiede molti impegni e disimpegni sfavorevoli nel taglio.

Fresatura di Cave

Fresatura per l'esecuzione di una cava o una sede

Smussatura

Fresatura per l'esecuzione di smussi su fori o contornature.

PRINCIPALI FORMULE FRESATURA

- $V_t = (D_{cap} \times n \times n) \div 1000$
- $n = (V_t \times 1000) \div (n \times D_{cap})$
- $F_z = V_f \div (n \times Z_c)$
- $V_f = F_z \times n \times Z_c$

LEGENDA

D_{cap} : Diametro di taglio alla profondità di taglio effettiva a_p (mm)

F_z : Avanzamento per Dente (mm/dente)

Z_c : Numero di denti effettivi della fresa

V_f : Avanzamento tavola (mm/min)

F_n : Avanzamento per giro (mm/giro)

a_p : Profondità di taglio (mm)

V_t : Velocità di taglio (m/min)

n : Velocità di rotazione mandrino (mm/min)

π : il suo valore è di 3.14



TIPOLOGIA UTENSILI FRESATURA FERVI

FRESA 90°

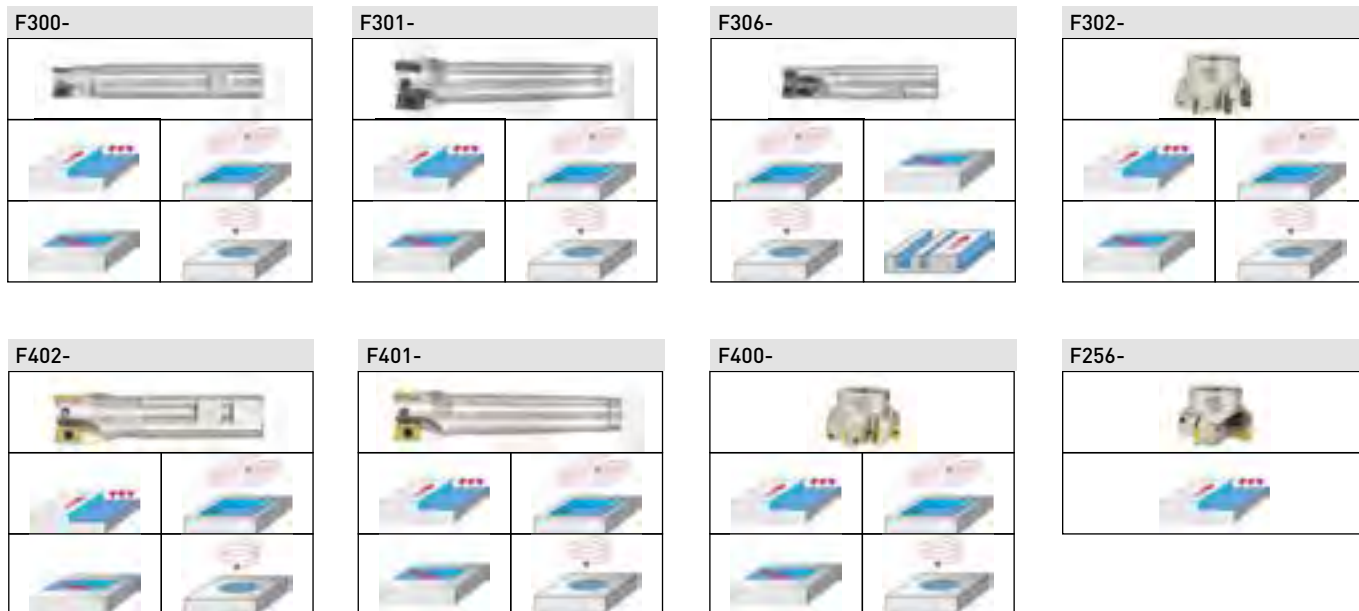

FRESA 45°

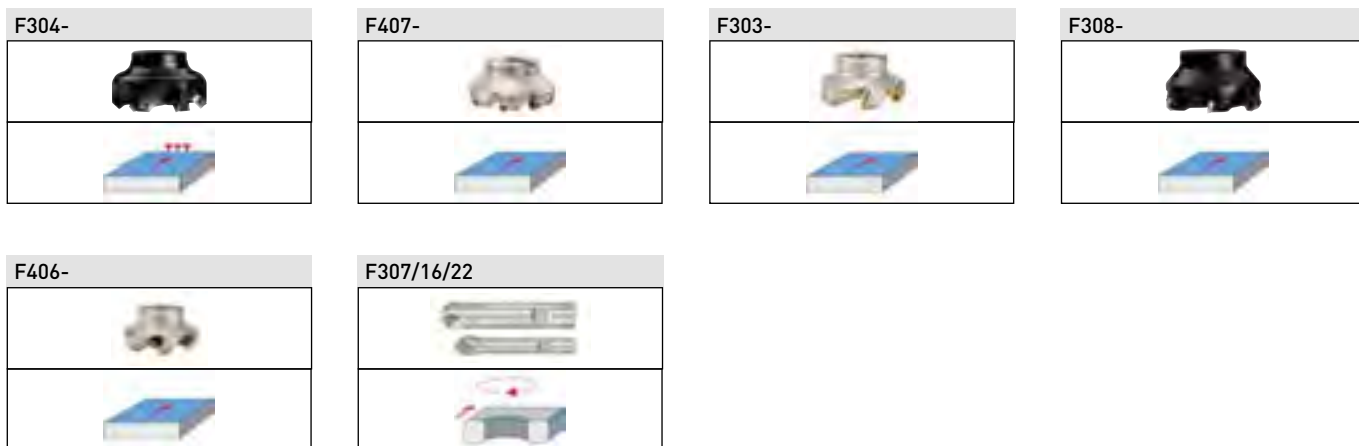

FRESA PER CONTORNATURA E SPIANATURA INSERTO TONDO

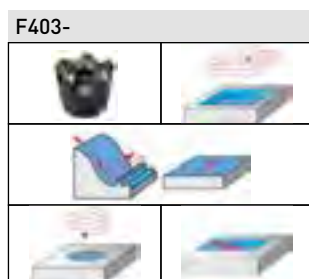

F300-
FRESA A INSERTO

Con codolo cilindrico

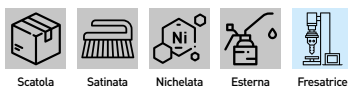

Art.	€	D	d	Z	L1	L2	Viti	Inserto (non incluso)
F300/12	€ 37,50	12 mm	12 mm	1	27 mm	120 mm	KV250	APKT1003...
F300/14	€ 37,50	14 mm	12 mm	1	27 mm	120 mm	KV250	APKT1003...
F300/16	€ 44,60	16 mm	16 mm	2	27 mm	120 mm	KV250	APKT1003...
F300/18	€ 49,70	18 mm	16 mm	2	27 mm	120 mm	KV250	APKT1003...
F300/20	€ 53,30	20 mm	20 mm	3	27 mm	120 mm	KV250	APKT1003...
F300/22	€ 53,30	22 mm	20 mm	3	27 mm	120 mm	KV250	APKT1003...
F300/25	€ 63,80	25 mm	20 mm	4	27 mm	120 mm	KV250	APKT1003...
F300/25/16	€ 63,80	25 mm	20 mm	2	44 mm	120 mm	KV400	APKT1604...
F300/25/16L	€ 74,20	25 mm	20 mm	2	44 mm	200 mm	KV400	APKT1604...
F300/32/16	€ 74,20	32 mm	25 mm	3	50 mm	120 mm	KV400	APKT1604...
F300/32/16L	€ 103,00	32 mm	32 mm	3	55 mm	200 mm	KV400	APKT1604...

F301-
FRESA A INSERTO

Con cono morse DIN 228/A

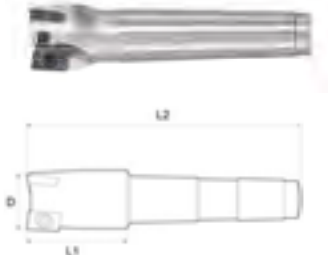
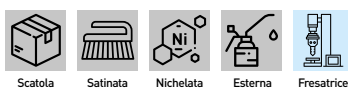

Art.	€	D	CM	Z	L1	L2	Viti	Inserto (non incluso)
F301/25	€ 66,10	25 mm	3	2	40 mm	125 mm	KV400	APKT1604...
F301/32	€ 70,60	32 mm	3	3	40 mm	125 mm	KV400	APKT1604...
F301/40	€ 90,10	40 mm	3	4	35 mm	125 mm	KV400	APKT1604...
F301/32CM4	€ 90,10	32 mm	4	3	45 mm	150 mm	KV400	APKT1604...
F301/40CM4	€ 95,90	40 mm	4	4	40 mm	150 mm	KV400	APKT1604...

F306-
FRESA A INSERTO

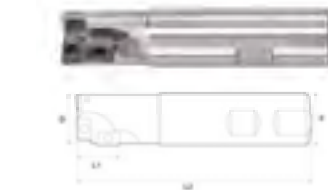
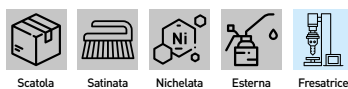
 Con taglio frontale forante per esecuzione di cave, con attacco cilindrico.
 Permette di realizzare cave dal pieno

Art.	€	D	d	Z	L1	L2	Viti	Inserto (non incluso)
F306/20	€ 82,30	20 mm	20 mm	3	18 mm	90 mm	KV250	APKT1003...
F306/25	€ 100,00	25 mm	25 mm	3	18 mm	100 mm	KV250	APKT1003...

F302-
FRESA A INSERTO

Con attacco a manicotto

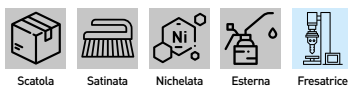

Art.	€	D	L	d	Z	Viti	Inserto (non incluso)
F302/040	€ 145,00	40 mm	40 mm	16 mm	4	KV400	APKT1604...
F302/050	€ 150,00	50 mm	45 mm	22 mm	4	KV400	APKT1604...
F302/063	€ 158,00	63 mm	50 mm	22 mm	6	KV400	APKT1604...
F302/080	€ 187,00	80 mm	50 mm	27 mm	7	KV400	APKT1604...
F302/100	€ 232,00	100 mm	50 mm	32 mm	8	KV400	APKT1604...



F304-

FRESA PER RECUPERO INSERTO

Con attacco a manicotto

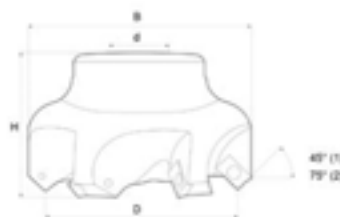

Art.	€	D	H	B	d	Z	Viti	Inserto (non incluso)
F304/063	€ 268,00	63 mm	42 mm	71.2 mm	22 mm	6	KV250	APKT1003...
F304/080	€ 217,00	80 mm	47 mm	84 mm	27 mm	5	KV400	APKT1604...

F402-

FRESA PER SPALLAMENTI

Con codolo cilindrico

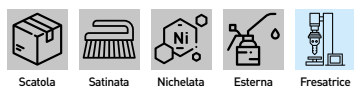

Art.	€	D	d	Z	L1	L2	Viti	Inserto (non incluso)
F402/25	€ 53,80	25 mm	20 mm	2	35 mm	110 mm	KV400	ADLT1503...
F402/32	€ 67,70	32 mm	25 mm	3	35 mm	120 mm	KV400	ADLT1503...
F402/25L	€ 73,30	25 mm	25 mm	2	35 mm	200 mm	KV400	ADLT1503...
F402/32L	€ 94,00	32 mm	25 mm	3	35 mm	200 mm	KV400	ADLT1503...

F401-

FRESA PER SPALLAMENTI

Con cono morse DIN 228/A

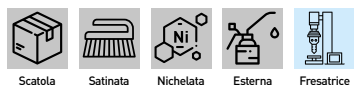

Art.	€	D	CM	Z	L1	L2	Viti	Inserto (non incluso)
F401/25	€ 65,00	25 mm	3	2	44 mm	130 mm	KV400	ADLT1503...
F401/32	€ 79,40	32 mm	3	3	44 mm	130 mm	KV400	ADLT1503...
F401/40	€ 87,00	40 mm	3	4	44 mm	130 mm	KV400	ADLT1503...
F401/40CM4	€ 102,00	40 mm	4	4	44 mm	153 mm	KV400	ADLT1503...

F400-

FRESA PER SPALLAMENTI

Con attacco a manicotto, consigliato l'utilizzo su macchine con potenze medie

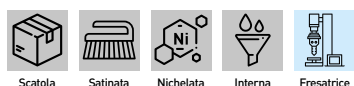

Art.	€	D	H	a	d	Z	Viti	Inserto (non incluso)
F400/040	€ 93,20	40 mm	40 mm	8,4 mm	16 mm	4	KV400	ADLT1503...
F400/050	€ 125,00	50 mm	40 mm	10,4 mm	22 mm	5	KV400	ADLT1503...
F400/063	€ 143,00	63 mm	40 mm	10,4 mm	22 mm	6	KV400	ADLT1503...
F400/080	€ 183,00	80 mm	50 mm	12,4 mm	27 mm	7	KV400	ADLT1503...
F400/100	€ 225,00	100 mm	50 mm	14,4 mm	32 mm	8	KV400	ADLT1503...

F256-

FRESA PER SPALLAMENTI

Con attacco a manicotto, consigliato l'utilizzo su macchine con potenze medie

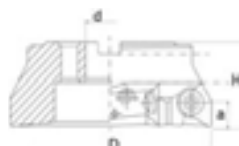

Art.	€	D	H	a	d	Z	Vite	Inserto (non incluso)
F256/040	€ 147,00	40 mm	40 mm	16 mm	16 mm	3	F256/644	TPKN1603...
F256/050	€ 151,00	50 mm	40 mm	16 mm	22 mm	3	F256/644	TPKN1603...
F256/063	€ 164,00	63 mm	40 mm	16 mm	22 mm	3	F256/644	TPKN1603...
F256/080	€ 168,00	80 mm	50 mm	22 mm	27 mm	4	F256/648	TPKN2204...
F256/100	€ 217,00	100 mm	50 mm	22 mm	32 mm	5	F256/648	TPKN2204...

F407-

PRO

FRESA A INSERTI NEGATIVI PER SPIANATURA

Con attacco a manicotto, consigliato l'utilizzo su macchine con potenze medio/alte.

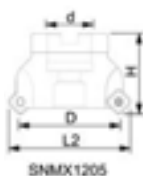
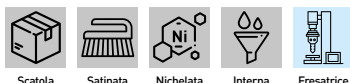

Art.	€	D	H	L2	d	Z	Vite	Inserto (non incluso)
F407/050	€ 123,00	50	40	63	22	4	KV401	ONMX1205... - SNMX1205...
F407/063	€ 164,00	63	40	75	22	6	KV401	ONMX1205... - SNMX1205...
F407/080	€ 204,00	80	50	93	27	7	KV401	ONMX1205... - SNMX1205...
F407/100	€ 246,00	100	50	113	32	8	KV401	ONMX1205... - SNMX1205...

F303-

FRESA A INSERTO

Con attacco a manicotto, consigliato l'utilizzo su macchine con potenze medie

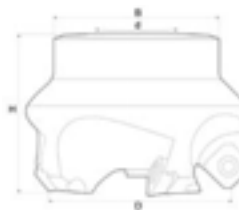
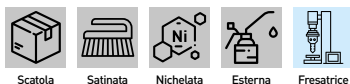

Art.	€	D	H	B	d	Z	Vite	Inserto (non incluso)
F303/040	€ 115,00	40 mm	45 mm	53 mm	16 mm	3	KV500	SEHX1204... / SEHT1204...
F303/050	€ 129,00	50 mm	48 mm	60 mm	22 mm	4	KV500	SEHX1204... / SEHT1204...
F303/063	€ 151,00	63 mm	50 mm	76 mm	22 mm	5	KV500	SEHX1204... / SEHT1204...
F303/080	€ 181,00	80 mm	50 mm	93 mm	27 mm	5	KV500	SEHX1204... / SEHT1204...
F303/100	€ 213,00	100 mm	50 mm	113 mm	32 mm	6	KV500	SEHX1204... / SEHT1204...
F303/125	€ 313,00	125 mm	60 mm	138 mm	40 mm	7	KV500	SEHX1204... / SEHT1204...

F308-

FRESA A INSERTI PER SPIANATURA

Con attacco a manicotto, grazie alla geometria molto positiva si ottengono ottime superfici lavorate

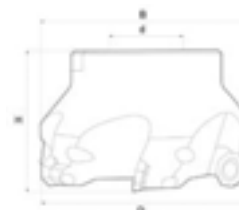

Art.	€	D	H	L2	d	Z	Vite	Inserto (non incluso)
F308/063	€ 215,00	63 mm	40 mm	68 mm	22 mm	5	KV400	OFEX05T3...
F308/080	€ 277,00	80 mm	50 mm	86 mm	27 mm	6	KV400	OFEX05T3...
F308/100	€ 353,00	100 mm	50 mm	106 mm	32 mm	7	KV400	OFEX05T3...



F406-

FRESA PER SPIANATURA

Con attacco a manicotto, consigliato l'utilizzo su macchine con potenze ridotte

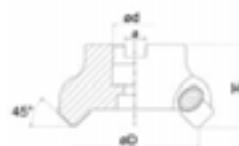

Art.	€	D	H	a	d	Z	Vite	Sottopiacchetta	Inserito (non incluso)
F406/40	€ 147,00	40 mm	48 mm	8,4 mm	16 mm	3	VT00440	WSSP	SEKN1203...
F406/50	€ 153,00	50 mm	48 mm	10,4 mm	22 mm	4	VT00440	WSSP	SEKN1203...
F406/63	€ 164,00	63 mm	48 mm	12,4 mm	22 mm	5	VT00440	WSSP	SEKN1203...
F406/80	€ 189,00	80 mm	50 mm	14,4 mm	27 mm	5	VT00440	WSSP	SEKN1203...
F406/100	€ 243,00	100 mm	50mm	16,4 mm	32 mm	6	VT00440	WSSP	SEKN1203...

F307/16/22

€ 147,00

SERIE SVASATORI A INSERTO

Con codolo cilindrico, per lavorazioni di sbavatura di fori, asole e tasche, per la fresatura di bordi piastra



D	16 / 22 mm
d	12 / 20 mm
L1	7 mm
L2	90 / 100 mm
Z	1 / 2
Viti	KV250
Inserito (non incluso)	TCMT1102

F403-

FRESA PER SPIANATURA

Con attacco a manicotto

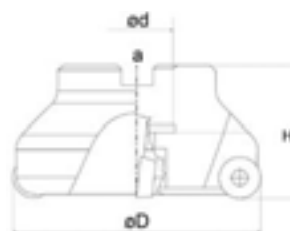

Art.	€	D	H	a	d	Z	Viti	Inserito (non incluso)
F403/40	€ 99,60	40 mm	40 mm	8,4 mm	16 mm	3	KV400	RPMT1204...
F403/50	€ 129,00	50 mm	40 mm	10,4 mm	22 mm	4	KV400	RPMT1204...
F403/63	€ 155,00	63 mm	40 mm	10,4 mm	22 mm	5	KV400	RPMT1204...
F403/80	€ 183,00	80 mm	50 mm	12,4 mm	27 mm	6	KV400	RPMT1204...
F403/100	€ 217,00	100 mm	50 mm	14,4 mm	32 mm	6	KV400	RPMT1204...



BSTG16 € 24,60
SET 5 BASI
16MM



BU3550 € 24,60
SET 5
BUSSOLE



BSCL09 € 24,60
SET 5 BASI
9MM



BSCL12 € 24,60
SET 5 BASI
12MM



BU4560 € 24,60
SET 5
BUSSOLE



BSSS12 € 24,60
5 BASI
QUADRATE
12MM



BSVJ16 € 24,60
SET 5 BASI
16MM



BSDJ11 € 27,50
5 BASI
ROMBOIDALI
11MM



BU4050 € 27,00
SET 5
BUSSOLE



RICAPCLN € 16,60
STAFFA BASE
VITE



RICAPTGN € 15,40
SET BASE
STAFFA VITE



RICAPSSN € 16,60
STAFFA BASE
STAFFA VITE



STAFCKJNR € 19,50
STAFFA
UTENSILE DX



STAFCKJNL € 19,50
STAFFA
UTENSILE SX



BASECKJNR € 11,30
BASE
UTENSILE DX



BASECKJNL € 11,30
BASE
UTENSILE SX



VITECKJN € 4,58
VITE UTENSILE



PDJNRKIT € 19,00
KIT RICAMBI



PWLNRRKIT € 15,90
SET BASE
STAFFA VITE



MCLNBASE25/32 € 19,30
BASE



CTMTMC16/20 € 23,80
STAFFA DI
RICAMBIO PER
16 - 20



CTMTMC25/32 € 23,80
STAFFA DI
RICAMBIO PER
25 - 32



MTFNBASE25/32 € 15,00
BASE



CTFP10/12 € 23,80
STAFFA



CTFPBASE25/32 € 15,00
BASE
Di ricambio per
25 - 32



BSER16 € 32,50
SET 5 BASI
TRIANGOLARI
16MM



VT00440 € 20,80
5 VITI PER
FRESA



BSNR16 € 32,50
SET 5 BASI
16 mm



F256/648 € 12,50
VITI FRESA
080/125



KVX
SET 10 VITI



F256/644 € 7,00
VITI FRESA
040/063



WSSP € 8,50
SOTTOPLACCHETTA

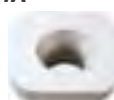

Art.	€	Vite
KV200	€ 20,40	T8 / M2
KV250	€ 20,40	T8 / M2,5
KV300	€ 20,40	T15 / M3
KV350	€ 20,40	T15 / M3,5
KV400	€ 20,40	T15 / M4
KV401	€ 20,40	T20 / M4
KV450	€ 20,40	T15 / M4,5
KV500	€ 20,40	T20 / M5



IDENTIFICAZIONE INSERTI TORNITURA E FRESATURA

C	N	M	G	12	04	08
1	2	3	4	5	6	7

1 - Forma dell'inserto

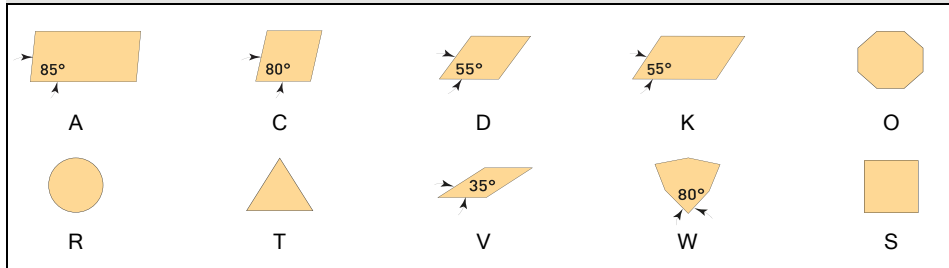

2 - Spoglia inferiore

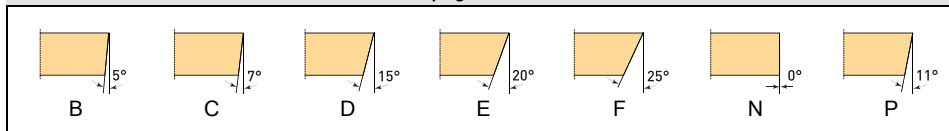

4 - Tipo inserto



5 - Lunghezza tagliente

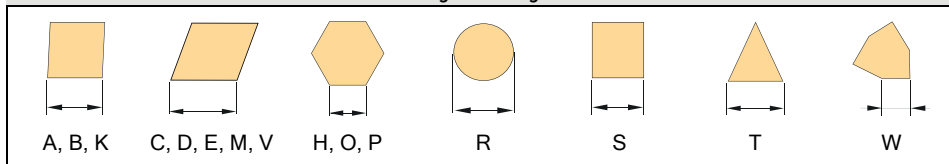

7 - Raggio

	04	r 0,4
	08	r 0,8
	12	r 1,2
	10	r 1,0

3 - Tolleranza

	m	s	d
E	0,025	0,025	0,025
H	0,013	0,025	0,013
L	0,025	0,025	0,05 - 0,13
K	0,013	0,025	0,05 - 0,13
M	0,08	0,13	0,05 - 0,13
U	0,13 - 0,38	0,13 - 0,13	0,08 - 0,25

6 - Spessore

02	2,38 mm		
03	3,18 mm		
T3	3,97 mm		
04	4,76 mm		
05	5,56 mm		
06	6,35 mm		

CLASSIFICAZIONE ISO MATERIALI

ISO P ACCIAIO	ISO M ACCIAIO INOX	ISO K GHISA
Acciaio al piombo e da cementazione bonifica e da costruzione	Acciai ferritici Cr, austenitici, martensitici Cr, acciai duplex	Ghisa grigia, temprata, sferoidale, ghisa CGI, ferro sinterizzato

CARATTERISTICHE DEI GRADI DEGLI INSERTI

Grado	Rivest.	Condizione di lavoro	Refrigerante	
N	CVD	Stabile/Normale	X	
134	PVD	Stabile/Normale		X
234	PVD	Stabile/Normale		X
25	PVD	Stabile		X
20A	PVD	Stabile/Normale	X	X
F15	CVD	Stabile	X	X
F25	CVD	Stabile/Normale	X	X
M25	CVD	Stabile/Normale	X	X
M35	CVD	Normale/Interrotto	X	X

	Descrizione
	Rivestimento
CVD	Sono caratterizzati da un'elevata resistenza all'usura e un'eccellente adesione al metallo duro. Nella tornitura generale sono applicati negli acciai inossidabili e nei campi ISO P,M,K.
PVD	Aumentano la resistenza all'usura grazie alla loro durezza. Le loro tensioni di compressione contribuiscono ad aumentare la tenacità del tagliente e la resistenza alla formazione di cricche a pettine.
Condizione di lavoro	
Stabile	Tipologia di taglio in cui l'inserto ha una condizione di lavoro omogenea.
Normale	Tipologia di taglio in cui l'inserto può avere una condizione di interruzione/ripresa di taglio.
Interrotto	Tipologia di taglio in cui l'inserto avrà durante la lavorazione varie interruzioni/riprese di taglio.

IDENTIFICAZIONE INSERTI PER FILETTATURA

16	E	R	175	ISO
A1	A2	A3	A4	A5

A3 - Direzione di taglio	
R	Destro
L	Sinistro

A5 - Profilo filetto	
ISO	Filetto Metrico 60°
W	Filettatura Whitworth 55°
AG60	Profilo 60° (Filettatura Libera) 0,5 - 3mm
AG55	Profilo 55° (Filettatura Libera) 28 - 11 TPI

A1 - Lunghezza tagliente	
l	d
11	6,35
16	9,525
22	12,7

A2 - Filettatura	
E	I
Esterna	Interna

A4 - Passo filetto	
mm	Filetti/Pollice
$\frac{A4}{100}$ (0,5 - 3mm)	(28 - 11 TPI)

GUIDA ALLA SCELTA DELL'INSERTO

Tipo inserto	Materiali			Campo di utilizzo			Tipo lavorazione	
	P	M	K	Finitura	Media	Sgrossatura	Tornitura	Fresatura
CCMTx	●	●	○	✓			✓	
CCMTxA	●	○	○	✓			✓	
CNMGx	●	●	○	✓	✓		✓	
CNMGxF15	●	●	○	✓			✓	
CNMGxF25	○	●	○	✓			✓	
CNMGxM25	●	●	○		✓		✓	
CNMGxM35	○	●	○		✓		✓	
DCMTx	●	●	○	✓			✓	
DCMTxA	●	●	○	✓			✓	
DNMGx	●	●	○		✓		✓	
DNMGxM25	●	●	○		✓		✓	
DNMGxM35	○	●	○		✓		✓	
KNUx	●	●	○	✓			✓	
SCMTx	●	●	○	✓			✓	
SCMTxA1	●	●	○	✓			✓	
SCMTxA2	●	●	○	✓	✓		✓	
SCMTxA3	●	●	○	✓	✓		✓	
SNMGxF15	●	●	○	✓			✓	
SNMGxF25	○	●	○	✓			✓	
SNMGxM25	●	●	○		✓		✓	
SNMGxM35	○	●	○		✓		✓	
SPMRx	●	●	○	✓			✓	
TCMTx	●	●	○	✓	✓		✓	
TCMTxA	●	○	○	✓			✓	
WNMGx	●	●	○		✓		✓	
WNMGxM25	●	●	○		✓		✓	
WNMGxM35	○	●	○		✓		✓	



Tipo inserto	Materiali			Campo di utilizzo			Tipo lavorazione	
	P	M	K	Finitura	Media	Sgrossatura	Tornitura	Fresatura
TNMGx	●	●	○	✓			✓	
TNMGxF15	●	●	○	✓			✓	
TNMGxF25	●	●	○	✓			✓	
TNMGxM25	●	●	○		✓		✓	
TNMGxM35	○	●	○		✓		✓	
TPMRx	●	●	○	✓			✓	
VBMTx	○	●	○	✓			✓	
VBMTxA	●	●	○	✓	✓		✓	
ADLTx	●	●	○		✓	✓		✓
ADLTxA	●	●	○		✓	✓		✓
ADLTxA1	●	●	○		✓	✓		✓
APKTx	○	●	○		✓			✓
OFEXx	●	●	○	✓	✓			✓
OFEXxA	●	●	○	✓	✓			✓
ONMXxA	●	●	○	✓	✓			✓
RDHTx	●	●	○		✓	✓		✓
RPMTx	●	●	○		✓	✓		✓
SEHTx	●	●	○	✓	✓			✓
SEHTxA	○	●	○	✓	✓			✓
SEKNx	●	●	○		✓	✓		✓
SEHXx	○	●	○		✓	✓		✓
SEHXxA	●	○	○		✓	✓		✓
SNMXx	●	●	○	✓	✓			✓
SPKNx	●	○	○		✓	✓		✓
TPKNx	●	○	○		✓	✓		✓
GCMX	●	●	○				✓	
GCMXA	●	●	○				✓	

Legenda

- Applicazione Consigliata
- Applicazione Possibile
- ✓ Campo di applicazione consigliato

CCMTX

INSERTI PER TORNITURA

Positiva

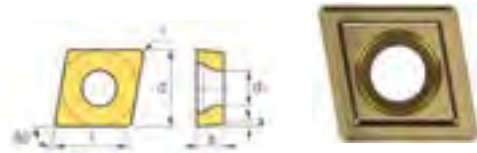

Art.	€	Dimensioni	d	l	S	r	d1	a°	Pack
CCMT060204N	€ 7,20	6 mm	6.35 mm	6.30 mm	2.38 mm	0.40 mm	2.80 mm	7°	10
CCMT09T304N	€ 8,30	9 mm	9.52 mm	9.70 mm	3.97 mm	0.40 mm	4.40 mm	7°	10
CCMT09T308N	€ 8,30	9 mm	9.52 mm	9.70 mm	3.97 mm	0.80 mm	4.40 mm	7°	10
CCMT120408N	€ 11,00	12 mm	12.70 mm	12.90 mm	4.76 mm	0.80 mm	5.50 mm	7°	10

CCMTXA

INSERTI PER TORNITURA

Positiva

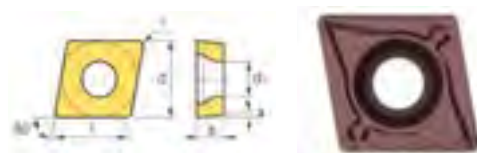

Art.	€	Dimensioni	d	l	S	r	d1	a°	Pack
CCMT06020420A	€ 7,50	6 mm	6.35 mm	6.30 mm	2.38 mm	0.40 mm	2.80 mm	7°	10
CCMT09T30420A	€ 8,80	9 mm	9.52 mm	9.70 mm	3.97 mm	0.40 mm	4.40 mm	7°	10
CCMT09T30820A	€ 8,80	9 mm	9.52 mm	9.70 mm	3.97 mm	0.80 mm	4.40 mm	7°	10
CCMT12040820A	€ 11,50	12 mm	12.70 mm	12.90 mm	4.76 mm	0.80 mm	5.50 mm	7°	10

CNMGX

INSERTI PER TORNITURA

Negativa

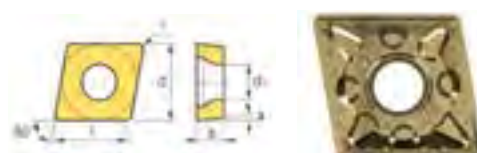
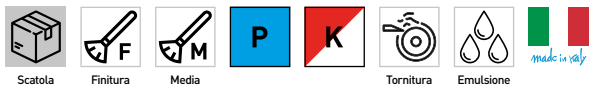

Art.	€	Dimensioni	d	l	S	r	d1	a°	Pack
CNMG120404N	€ 9,20	12 mm	12.70 mm	12.90 mm	4.76 mm	0.40 mm	5.16 mm	-	10
CNMG120408N	€ 9,20	12 mm	12.70 mm	12.90 mm	4.76 mm	0.80 mm	5.16 mm	-	10

CNMGXF15

INSERTO PER TORNITURA

Negativa

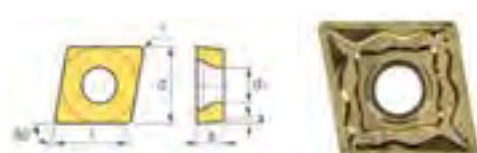

Art.	€	Dimensioni	d	l	S	r	d1	a°	Pack
CNMG120404F15	€ 9,70	12 mm	12.70 mm	12.90 mm	4.76 mm	0.40 mm	5.16 mm	-	10

CNMGXF25

INSERTO PER TORNITURA

Negativa

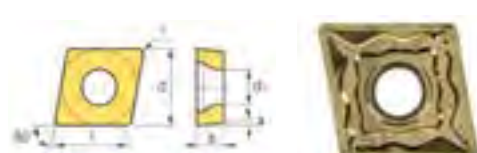

Art.	€	Dimensioni	d	l	S	r	d1	a°	Pack
CNMG120404F25	€ 9,70	12 mm	12.70 mm	12.90 mm	4.76 mm	0.40 mm	5.16 mm	-	10



CNMGXM25

INSERTO PER TORNITURA

Negativa

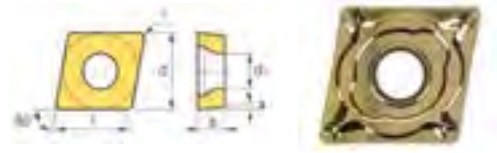

Art.	€	Dimensioni	d	l	S	r	d1	a°	Pack
CNMG120408M25	€ 9,70	12 mm	12.70 mm	12.90 mm	4.76 mm	0.80 mm	5.16 mm	-	10

CNMGXM35

INSERTO PER TORNITURA

Negativa

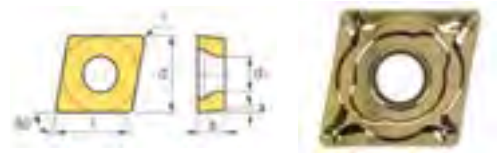

Art.	€	Dimensioni	d	l	S	r	d1	a°	Pack
CNMG120408M35	€ 9,70	12 mm	12.70 mm	12.90 mm	4.76 mm	0.80 mm	5.16 mm	-	10

DCMTX

INSERTI PER TORNITURA

Positiva

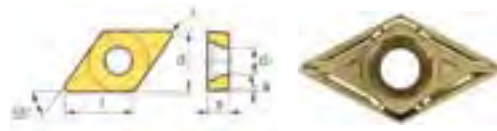

Art.	€	Dimensioni	d	l	S	r	d1	a°	Pack
DCMT070204N	€ 7,20	7 mm	6.35 mm	7.70 mm	2.38 mm	0.40 mm	2.80 mm	7°	10
DCMT11T304N	€ 9,50	11 mm	9.52 mm	11.60 mm	3.97 mm	0.40 mm	2.20 mm	7°	10

DCMTXA

INSERTO PER TORNITURA

Positiva

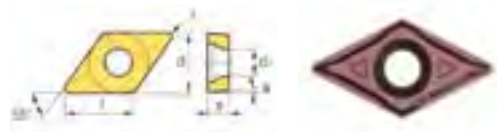

Art.	€	Dimensioni	d	l	S	r	d1	a°	Pack
DCMT07020420A	€ 7,50	7 mm	6.35 mm	7.70 mm	2.38 mm	0.40 mm	2.80 mm	7°	10
DCMT11T30420A	€ 9,90	11 mm	9.52 mm	11.60 mm	3.97 mm	0.40 mm	2.20 mm	7°	10

DNMGX

INSERTI PER TORNITURA

Negativa

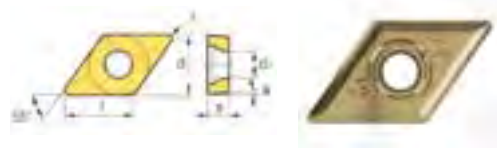

Art.	€	Dimensioni	d	l	S	r	d1	a°	Pack
DNMG150608N	€ 13,80	15 mm	12.70 mm	15.50 mm	6.35 mm	0.80 mm	5.20 mm	-	10

DNMGXM25

INSERTO PER TORNITURA

Negativa

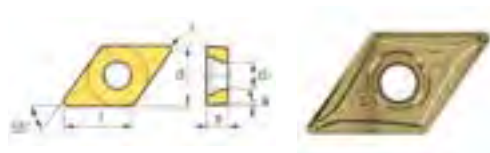

Art.	€	Dimensioni	d	l	S	r	d1	a°	Pack
DNMG150608M25	€ 14,70	15 mm	12.70 mm	15.50 mm	6.35 mm	0.80 mm	5.20 mm	-	10

DNMGXM35

INSERTO PER TORNITURA

Negativa

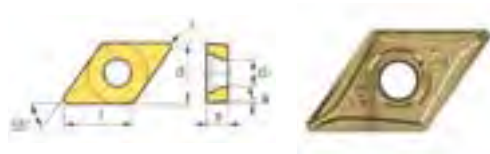

Art.	€	Dimensioni	d	l	S	r	d1	a°	Pack
DNMG150608M35	€ 14,70	15 mm	12.70 mm	15.50 mm	6.35 mm	0.80 mm	5.20 mm	-	10

KNUX

INSERTI PER TORNITURA

Positiva



Art.	€	Dimensioni	d	l	S	r	a°	Pack
KNUX160405RN	€ 11,80	16 mm	9.52 mm	19.72 mm	4.76 mm	0.50 mm	-	10
KNUX160410RN	€ 11,80	16 mm	9.52 mm	19.72 mm	4.76 mm	1.00 mm	-	10
KNUX160405LN	€ 11,80	16 mm	9.52 mm	19.72 mm	4.76 mm	0.50 mm	-	10
KNUX160410LN	€ 11,80	16 mm	9.52 mm	19.72 mm	4.76 mm	1.00 mm	-	10

SCMTX

INSERTI PER TORNITURA

Positiva



Art.	€	Dimensioni	d	l	S	r	d1	a°	Pack
SCMT09T304N	€ 8,40	9 mm	9.52 mm	9.52 mm	3.97 mm	0.40 mm	4.40 mm	7°	10
SCMT09T308N	€ 8,40	9 mm	9.52 mm	9.52 mm	3.97 mm	0.80 mm	4.40 mm	7°	10
SCMT120408N	€ 11,70	12 mm	12.70 mm	12.70 mm	4.76 mm	0.80 mm	5.50 mm	7°	10

SCMTXA1

INSERTO PER TORNITURA

Positiva

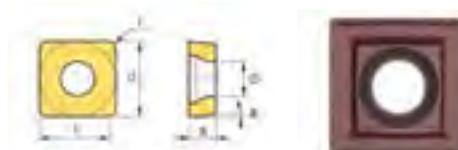

Art.	€	Dimensioni	d	l	S	r	d1	a°	Pack
SCMT09T30420A	€ 8,90	9 mm	9.52 mm	9.52 mm	3.97 mm	0.40 mm	4.40 mm	7°	10



SCMTXA2

INSERTO PER TORNITURA

Positiva



Art.	€	Dimensioni	d	l	S	r	d1	a°	Pack
SCMT09T30820A	€ 8,90	9 mm	9.52 mm	9.52 mm	3.97 mm	0.80 mm	4.40 mm	7°	10

SCMTXA3

INSERTO PER TORNITURA

Positiva

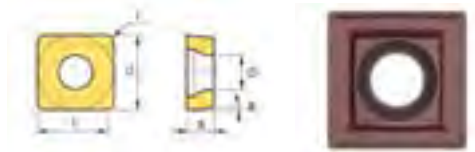

Art.	€	Dimensioni	d	l	S	r	d1	a°	Pack
SCMT12040820A	€ 12,20	12 mm	12.70 mm	12.70 mm	4.76 mm	0.80 mm	5.50 mm	7°	10

SNMGXF15

INSERTO PER TORNITURA

Negativa



Art.	€	Dimensioni	d	l	S	r	d1	a°	Pack
SNMG120404F15	€ 10,90	12 mm	12.70 mm	12.70 mm	4.76 mm	0.40 mm	5.16 mm	-	10

SNMGXF25

INSERTO PER TORNITURA

Negativa



Art.	€	Dimensioni	d	l	S	r	d1	a°	Pack
SNMG120404F25	€ 10,90	12 mm	12.70 mm	12.70 mm	4.76 mm	0.40 mm	5.16 mm	-	10

SNMGXM25

INSERTO PER TORNITURA

Negativa

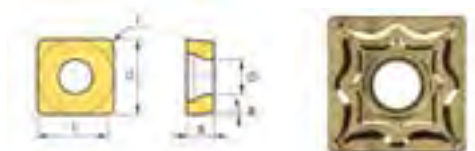

Art.	€	Dimensioni	d	l	S	r	d1	a°	Pack
SNMG120408M25	€ 10,90	12 mm	12.70 mm	12.70 mm	4.76 mm	0.80 mm	5.16 mm	-	10

SNMGXM35

INSERTO PER TORNITURA

Negativa



Art.	€	Dimensioni	d	l	S	r	d1	a°	Pack
SNMG120408M35	€ 10,90	12 mm	12.70 mm	12.70 mm	4.76 mm	0.80 mm	5.16 mm	-	10

SPMRX

INSERTI PER TORNITURA

Positiva



Art.	€	Dimensioni	d	l	S	r	a°	Pack
SPMR120304N	€ 9,60	12 mm	12.70 mm	12.70 mm	3.18 mm	0.40 mm	11°	10
SPMR120308N	€ 9,60	12 mm	12.70 mm	12.70 mm	3.18 mm	0.80 mm	11°	10

TCMTX

INSERTI PER TORNITURA

Positiva



Art.	€	Dimensioni	d	l	S	r	d1	a°	Pack
TCMT090204N	€ 7,00	9 mm	3.40 mm	9.63 mm	2.38 mm	0.40 mm	2.50 mm	7°	10
TCMT110204N	€ 7,30	11 mm	6.35 mm	11.00 mm	2.38 mm	0.40 mm	2.80 mm	7°	10
TCMT16T304N	€ 9,30	16 mm	9.52 mm	16.50 mm	3.97 mm	0.40 mm	4.40 mm	7°	10
TCMT16T308N	€ 9,30	16 mm	9.52 mm	16.50 mm	3.97 mm	0.80 mm	4.40 mm	7°	10

TCMTXA

INSERTO PER TORNITURA

Positiva



Art.	€	Dimensioni	d	l	S	r	d1	a°	Pack
TCMT09020420A	€ 7,40	9 mm	3.40 mm	9.63 mm	2.38 mm	0.40 mm	2.50 mm	7°	10
TCMT11020420A	€ 7,70	11 mm	6.35 mm	11.00 mm	2.38 mm	0.40 mm	2.80 mm	7°	10
TCMT16T30420A	€ 9,80	16 mm	9.52 mm	16.50 mm	3.97 mm	0.40 mm	4.40 mm	7°	10
TCMT16T30820A	€ 9,80	16 mm	9.52 mm	16.50 mm	3.97 mm	0.80 mm	4.40 mm	7°	10

WNMGX

INSERTI PER TORNITURA

Negativa

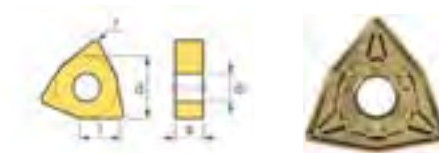

Art.	€	Dimensioni	d	l	S	r	d1	a°	Pack
WNMG080408N	€ 11,70	8 mm	12.70 mm	8.70 mm	4.76 mm	0.80 mm	5.10 mm	-	10



WNMGXM25

INSERTO PER TORNITURA

Negativa



Art.	€	Dimensioni	d	l	S	r	d1	a°	Pack
WNMG080408M25	€ 12,20	8 mm	12.70 mm	8.70 mm	4.76 mm	0.80 mm	5.10 mm	-	10

WNMGXM35

INSERTO PER TORNITURA

Negativa



Art.	€	Dimensioni	d	l	S	r	d1	a°	Pack
WNMG080408M35	€ 12,20	8 mm	12.70 mm	8.70 mm	4.76 mm	0.80 mm	5.10 mm	-	10

TNMGX

INSERTI PER TORNITURA

Negativa



Art.	€	Dimensioni	d	l	S	r	d1	a°	Pack
TNMG160404N	€ 9,90	16 mm	9.52 mm	16.50 mm	4.76 mm	0.40 mm	3.81 mm	-	10
TNMG160408N	€ 9,90	16 mm	9.52 mm	16.50 mm	4.76 mm	0.80 mm	3.81 mm	-	10
TNMG220408N	€ 11,00	22 mm	12.70 mm	18.25 mm	4.76 mm	0.80 mm	5.16 mm	-	10

TNMGXF15

INSERTO PER TORNITURA

Negativa

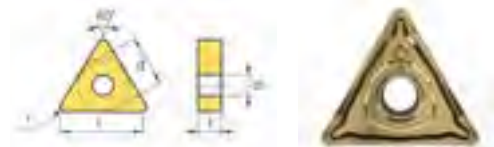

Art.	€	Dimensioni	d	l	S	r	d1	a°	Pack
TNMG160404F15	€ 10,50	16 mm	9.52 mm	16.50 mm	4.76 mm	0.40 mm	3.81 mm	-	10

TNMGXF25

INSERTO PER TORNITURA

Negativa

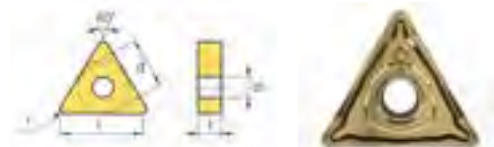

Art.	€	Dimensioni	d	l	S	r	d1	a°	Pack
TNMG160404F25	€ 10,50	16 mm	9.52 mm	16.50 mm	4.76 mm	0.40 mm	3.81 mm	-	10

TNMGXM25

INSERTO PER TORNITURA

Negativa

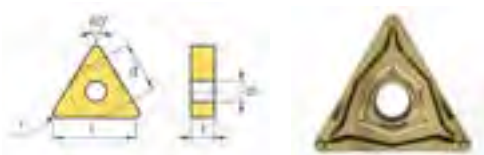

Art.	€	Dimensioni	d	l	S	r	d1	a°	Pack
TNMG160408M25	€ 10,50	16 mm	9.52 mm	16.50 mm	4.76 mm	0.80 mm	3.81 mm	-	10

TNMGXM35

INSERTO PER TORNITURA

Negativa



Art.	€	Dimensioni	d	l	S	r	d1	a°	Pack
TNMG160408M35	€ 10,50	16 mm	9.52 mm	16.50 mm	4.76 mm	0.80 mm	3.81 mm	-	10

TPMRX

INSERTI PER TORNITURA

Positiva



Art.	€	Dimensioni	d	l	S	r	a°	Pack
TPMR110304N	€ 6,30	11 mm	5.98 mm	10.37 mm	3.18 mm	0.40 mm	11°	10
TPMR110308N	€ 6,30	11 mm	5.98 mm	10.37 mm	3.18 mm	0.80 mm	11°	10
TPMR160304N	€ 8,40	16 mm	9.23 mm	16 mm	3.18 mm	0.40 mm	11°	10
TPMR160308N	€ 8,40	16 mm	9.23 mm	16 mm	3.18 mm	0.80 mm	11°	10

VBMTX

INSERTI PER TORNITURA

Positiva

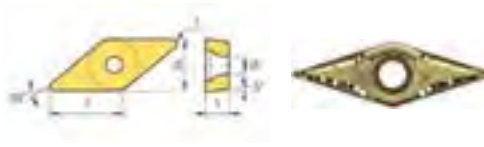

Art.	€	Dimensioni	d	l	S	r	d1	a°	Pack
VBMT160404N	€ 13,40	16 mm	9.52 mm	16.60 mm	4.76 mm	0.40 mm	4.40 mm	5°	10

VBMTXA

INSERTO PER TORNITURA

Positiva

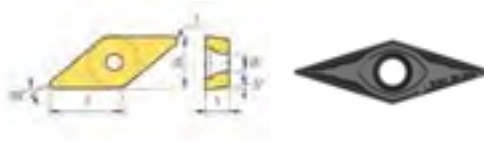

Art.	€	Dimensioni	d	l	S	r	d1	a°	Pack
VBMT16040420A	€ 14,20	16 mm	9.52 mm	16.60 mm	4.76 mm	0.40 mm	4.40 mm	5°	10



ADLTXA

INSERTI PER FRESATURA

90°

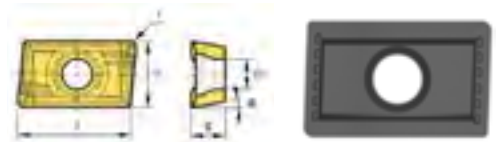

Art.	€	Dimensioni	d	l	S	r	d1	a°	Pack
ADLT150308R20A	€ 10,30	15 mm	9.52 mm	14.5 mm	3.18 mm	0.80 mm	4.50 mm	15°	10

ADLTX

INSERTI PER FRESATURA

90°



Art.	€	Dimensioni	d	l	S	r	d1	a°	Pack
ADLT1503ZZR234	€ 9,00	15 mm	9.52 mm	14.50 mm	3.18 mm	0.80 mm	4.50 mm	15°	10

ADLTXA1

INSERTO PER FRESATURA

90°

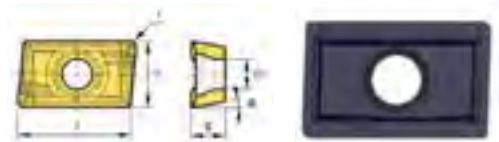

Art.	€	Dimensioni	d	l	S	r	d1	a°	Pack
ADLT1503ZZR20A	€ 9,60	15 mm	9.52 mm	14.50 mm	3.18 mm	0.80 mm	4.50 mm	15°	10

APKTX

INSERTI PER FRESATURA

90°



Art.	€	Dimensioni	d	l	S	r	d1	a°	Pack
APKT1003PDER20A	€ 11,80	10 mm	6.70 mm	10.00 mm	3.18 mm	0.50 mm	3.20 mm	11°	10
APKT1604PDER20A	€ 13,40	16 mm	9.50 mm	16.30 mm	4.76 mm	0.90 mm	4.40 mm	11°	10

OFEXX

INSERTI PER FRESATURA

45°

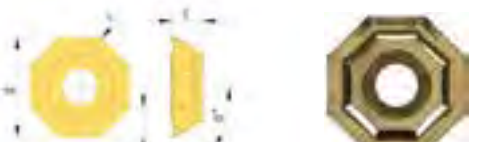

Art.	€	Dimensioni	d	l	S	r	d1	a°	Pack
OFEX05T305234	€ 12,30	5 mm	12.80 mm	3.70 mm	3.97 mm	0.50 mm	4.56 mm	25°	10

OFEXXA

INSERTO PER FRESATURA

45°



Art.	€	Dimensioni	d	l	S	r	d1	a°	Pack
OFEX05T30520A	€ 13,00	5 mm	12.80 mm	3.70 mm	3.97 mm	0.50 mm	4.56 mm	25°	10

ONMXXA

INSERTO PER FRESATURA

45°

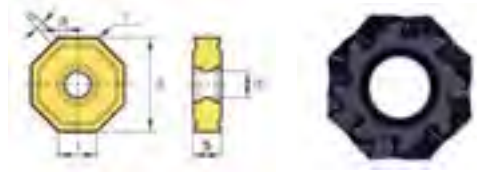

Art.	€	Dimensioni	d	l	S	d1	a°	Pack
ONMX120520A	€ 15,90	12 mm	12.70 mm	1.50 mm	5.56 mm	6.00 mm	-	10

RDHTX

INSERTI PER FRESATURA

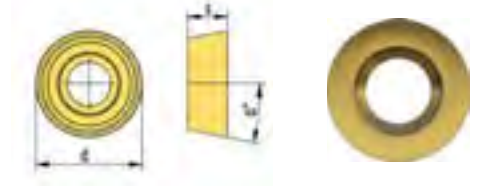
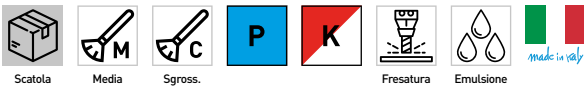

Art.	€	Dimensioni	d	S	a°	Pack
RDHT10T3M0-N	€ 11,00	10 mm	10 mm	3.97 mm	15°	10

RPMTX

INSERTI PER FRESATURA

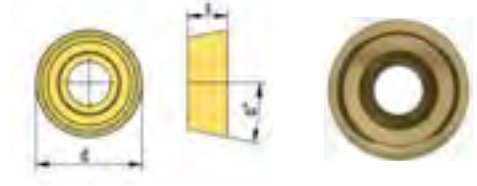
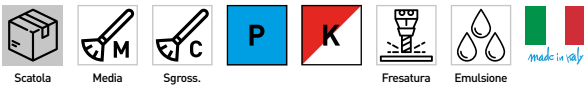

Art.	€	Dimensioni	d	S	a°	Pack
RPMT1204N	€ 10,40	12 mm	12 mm	4.76 mm	11°	10

SEHTX

INSERTI PER FRESATURA

45°



Art.	€	Dimensioni	d	a	S	d1	a°	Pack
SEHT1204AFN234	€ 16,20	12 mm	12.70 mm	1.80 mm	4.76 mm	5.50 mm	20°	10

SEHTXA

INSERTO PER FRESATURA

45°

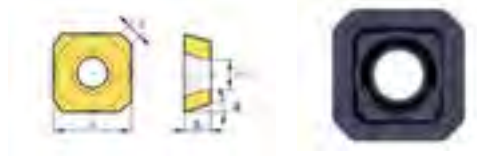

Art.	€	Dimensioni	d	a	S	d1	a°	Pack
SEHT1204AFN20A	€ 17,10	12 mm	12.70 mm	1.80 mm	4.76 mm	5.50 mm	20°	10



SEKNX

INSERTI PER FRESATURA

45°

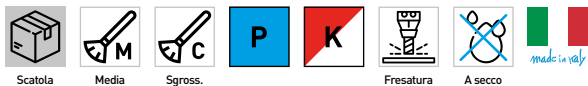

Art.	€	Dimensioni	d	a	S	a°	Pack
SEKN1203AFN25	€ 9,30	12 mm	12.70 mm	1.80 mm	3.18 mm	20°	10

SEHXX

INSERTI PER FRESATURA

45°



Art.	€	Dimensioni	d	a	S	d1	a°	Pack
SEHX1204234	€ 12,10	12 mm	12.70 mm	1.80 mm	4.76 mm	5.50 mm	20°	10

SEHXXA

INSERTO PER FRESATURA

45°

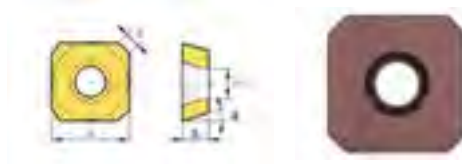

Art.	€	Dimensioni	d	a	S	d1	a°	Pack
SEHX120420A	€ 12,80	12 mm	12.70 mm	1.80 mm	4.76 mm	5.50 mm	20°	10

SNMXX

INSERTO PER FRESATURA

45°



Art.	€	Dimensioni	d	a	S	d1	a°	Pack
SNMX120520A	€ 12,50	12 mm	12.70 mm	1.80 mm	5.56 mm	6.00 mm	-	10

SPKNX

INSERTI PER FRESATURA

45°



Art.	€	Dimensioni	l	a	S	a°	Pack
SPKN1203R25	€ 10,70	12 mm	12.7 mm	1.40 mm	3.18 mm	11°	10

TPKNX

INSERTI PER FRESATURA

45°



Art.	€	Dimensioni	d	l	a	S	a°	Pack
TPKN1603R25	€ 8,40	16 mm	9.52 mm	16.50 mm	1.47 mm	3.18 mm	11°	10
TPKN2204R25	€ 12,10	22 mm	12.70 mm	22.00 mm	1.47 mm	4.76 mm	11°	10

16IRX
INSERTI PER FILETTATURA INTERNA

Art.	€	Filetto	Pack
11IRA55134	€ 11,00	Whitworth 28 - 11 TPI	10
11IRA60134	€ 11,00	Metric 0.2 - 3 mm	10
16IR100ISO134	€ 12,30	P. Metric 1 mm	10
16IR125ISO134	€ 12,30	P. Metric 1.25 mm	10
16IR150ISO134	€ 12,30	P. Metric 1.50 mm	10
16IR175ISO134	€ 12,30	P. Metric 1.75 mm	10
16IR200ISO134	€ 12,30	P. Metric 2.00 mm	10
16IR250ISO134	€ 12,30	P. Metric 2.50 mm	10
16IR300ISO134	€ 12,30	P. Metric 3.00 mm	10
16IRAG60134	€ 12,30	Metric 0.2 - 3 mm	10
16IR14W134	€ 12,30	Whitworth 14 TPI	10
16IR11W134	€ 12,30	Whitworth 11 TPI	10
16IRAG55134	€ 12,30	Whitworth 28 - 11 TPI	10

16ERX
INSERTI PER FILETTATURA ESTERNA

Art.	€	Filetto	Pack
16ER100ISO134	€ 12,30	P. Metric 1 mm	10
16ER125ISO134	€ 12,30	P. Metric 1.25 mm	10
16ER150ISO134	€ 12,30	P. Metric 1.50 mm	10
16ER175ISO134	€ 12,30	P. Metric 1.75 mm	10
16ER200ISO134	€ 12,30	P. Metric 2.00 mm	10
16ER250ISO134	€ 12,30	P. Metric 2.50 mm	10
16ER300ISO134	€ 12,30	P. Metric 3.00 mm	10
16ERAG60134	€ 12,30	Metric 0.2 - 3 mm	10
16ER14W134	€ 12,30	Whitworth 14 TPI	10
16ER11W134	€ 12,30	Whitworth 11 TPI	10
16ERAG55134	€ 12,30	Whitworth 28 - 11 TPI	10

GCMX
INSERTI PER TRONCATURA

Art.	€	Spessore	r	Pack
GCMX2N134	€ 8,80	2.20 mm	0.20 mm	10
GCMX3N134	€ 8,80	3.10 mm	0.20 mm	10
GCMX4N134	€ 9,90	4.10 mm	0.20 mm	10
GCMX5N134	€ 10,40	5.10 mm	0.3 mm	10

GCMXA
INSERTO PER TRONCATURA

Art.	€	Spessore	r	Pack
GCMX2N20A	€ 9,20	2.20 mm	0.20 mm	10
GCMX3N20A	€ 9,20	3.10 mm	0.20 mm	10
GCMX4N20A	€ 10,50	4.10 mm	0.20 mm	10
GCMX5N20A	€ 11,00	5.10 mm	0.30 mm	10

165X
INSERTI PER SCANALATURA

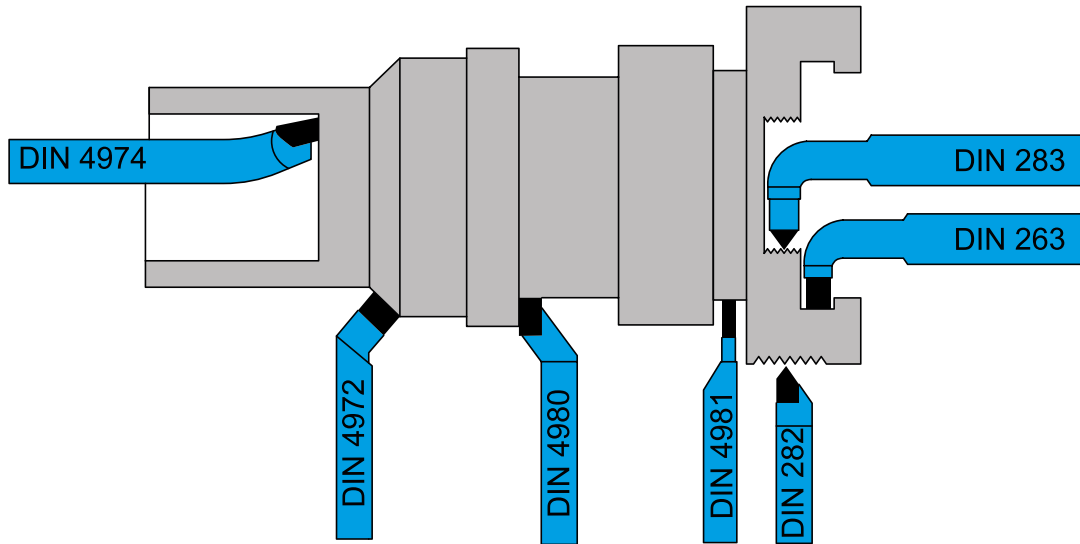

Art.	€	S	Pack
165110134	€ 12,30	1.10 mm	10
165130134	€ 12,30	1.30 mm	10
165160134	€ 12,30	1.60 mm	10
165185134	€ 12,30	1.85 mm	10

Art.	€	S	Pack
165215134	€ 12,30	2.15 mm	10
165265134	€ 12,30	2.65 mm	10
165315134	€ 12,30	3.15 mm	10

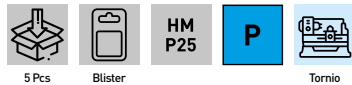

B005-

SERIE UTENSILI BRASATI



Art.	€	Kit
B005	€ 25,40	1BRAS411108RP - 1BRAS411110RP - 1BRAS410312RP - 1BRAS410412RP - 1BRAS410912RP
B005/16	€ 38,10	1BRAS411110RP - 1BRAS411112RP - 1BRAS410316RP - 1BRAS410416RP - 1BRAS410916RP
B005/20	€ 47,70	1BRAS411112RP - 1BRAS411116RP - 1BRAS410320RP - 1BRAS410420RP - 1BRAS410920RP

BRFEX

BRASATO PER FILETTATURA ESTERNA

DIN 282, per l'esecuzione di tutte le filettature esterne a 60°

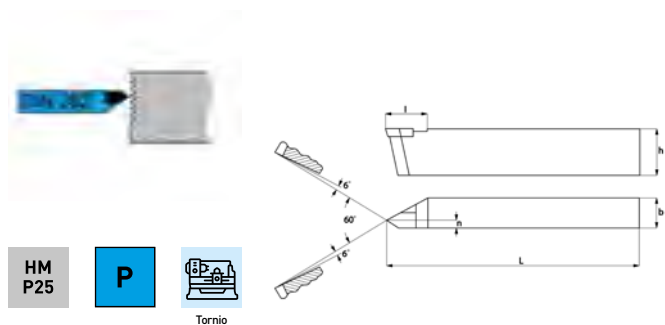

Art.	€	L	b	h
BRFE12RP	€ 9,10	90 mm	12 mm	12 mm
BRFE16RP	€ 10,40	100 mm	16 mm	16 mm
BRFE20RP	€ 12,90	125 mm	20 mm	20 mm
BRFE25RP	€ 15,60	140 mm	25 mm	25 mm

BRFIX

BRASATO PER FILETTATURA INTERNA

DIN 283, per l'esecuzione di tutte le filettature interne a 60°

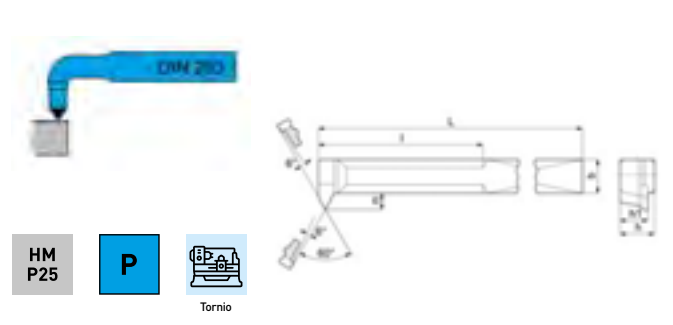

Art.	€	L	b	h
BRFI10RP	€ 9,60	150 mm	10 mm	10 mm
BRFI12RP	€ 10,40	180 mm	12 mm	12 mm
BRFI16RP	€ 12,90	210 mm	16 mm	16 mm
BRFI20RP	€ 13,40	250 mm	20 mm	20 mm
BRFI25RP	€ 16,70	300 mm	25 mm	25 mm

BRAS4111X

BRASATO PER FORI CIECHI

ISO 9 - DIN 4974.

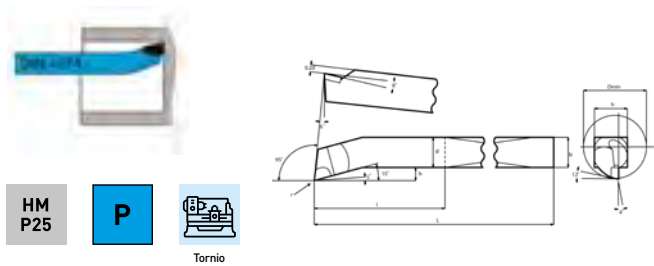

Art.	€	L	b	h
BRAS411108RP	€ 6,90	125 mm	8 mm	8 mm
BRAS411110RP	€ 8,40	150 mm	10 mm	10 mm
BRAS411112RP	€ 8,90	180 mm	12 mm	12 mm
BRAS411116RP	€ 10,70	210 mm	16 mm	16 mm
BRAS411120RP	€ 11,50	250 mm	20 mm	20 mm
BRAS411125RP	€ 17,30	300 mm	25 mm	25 mm
BRAS411132RP	€ 20,70	355 mm	32 mm	32 mm

BRCIX

BRASATO PER CANALINI INTERNI

DIN 263.

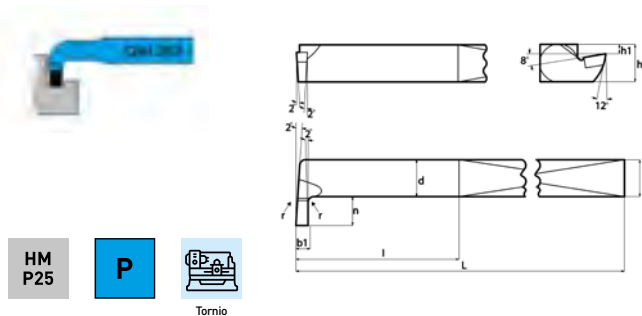

Art.	€	L	b	h	b1
BRCI10RP	€ 9,90	150 mm	10 mm	10 mm	3 mm
BRCI12RP	€ 9,90	180 mm	12 mm	12 mm	4 mm
BRCI16RP	€ 11,30	210 mm	16 mm	16 mm	5 mm
BRCI20RP	€ 12,30	210 mm	20 mm	20 mm	6 mm
BRCI25RP	€ 15,90	300 mm	25 mm	25 mm	8 mm

BRAS4104X

BRASATO PER SFACCIARE

ISO 6 - DIN 4980.

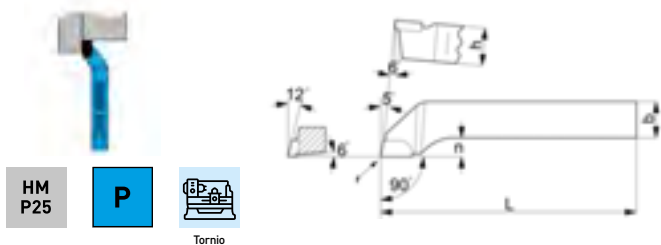

Art.	€	L	b	h
BRAS410410LP	€ 6,00	90 mm	10 mm	10 mm
BRAS410410RP	€ 6,00	90 mm	10 mm	10 mm
BRAS410412LP	€ 6,60	100 mm	12 mm	12 mm
BRAS410412RP	€ 6,60	100 mm	12 mm	12 mm
BRAS410416LP	€ 7,90	110 mm	16 mm	16 mm
BRAS410416RP	€ 7,90	110 mm	16 mm	16 mm
BRAS410420LP	€ 9,60	125 mm	20 mm	20 mm
BRAS410420RP	€ 9,60	125 mm	20 mm	20 mm
BRAS410425RP	€ 14,00	140 mm	25 mm	25 mm

BRAS4103X

BRASATO PER SGROSSARE

ISO 2 - DIN 4972.

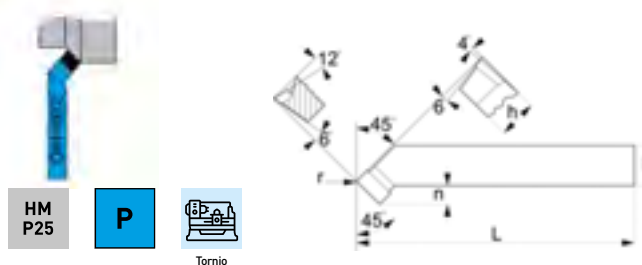

Art.	€	L	b	h
BRAS410310RP	€ 6,30	90 mm	10 mm	10 mm
BRAS410312LP	€ 6,90	100 mm	12 mm	12 mm
BRAS410312RP	€ 6,90	100 mm	12 mm	12 mm
BRAS410316LP	€ 8,30	110 mm	16 mm	16 mm
BRAS410316RP	€ 8,30	110 mm	16 mm	16 mm
BRAS410320LP	€ 10,20	125 mm	20 mm	20 mm
BRAS410320RP	€ 10,20	125 mm	20 mm	20 mm
BRAS410325RP	€ 14,70	140 mm	25 mm	25 mm

BRAS4109X

BRASATO PER TRONCARE

ISO 7 - DIN 4981.

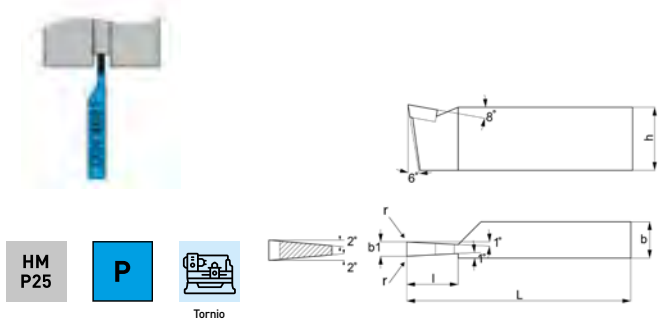

Art.	€	L	b	h	b1
BRAS410912RP	€ 6,30	100 mm	8 mm	12 mm	3 mm
BRAS410916RP	€ 6,90	110 mm	10 mm	16 mm	3,5 mm
BRAS410920RP	€ 7,70	125 mm	12 mm	20 mm	5 mm
BRAS410925RP	€ 10,90	140 mm	16 mm	25 mm	6 mm

B012-

BARRETTE TRATTATE E RETTIFICATE



Art.	€	phi	Lunghezza	Tolleranza
B012/04	€ 8,90	4 mm	200 mm	h9
B012/05	€ 9,90	5 mm	200 mm	h9
B012/06	€ 11,30	6 mm	200 mm	h9
B012/08	€ 14,70	8 mm	200 mm	h9
B012/10	€ 18,20	10 mm	200 mm	h9
B012/12	€ 23,10	12 mm	200 mm	h9
B012/13	€ 28,40	13 mm	135 mm	h9
B012/16	€ 43,50	16 mm	200 mm	h9
B012/20	€ 56,20	20 mm	200 mm	h9



B013-

BARRETTE TRATTATE E RETTIFICATE



HSS
CO 8%



Tornio

Art.	€	Dimensioni lati	Lunghezza	Tolleranza
B013/04X04	€ 10,30	4 x 4 mm	200 mm	h13
B013/05X05	€ 13,00	5 x 5 mm	200 mm	h13
B013/06X06	€ 14,30	6 x 6 mm	200 mm	h13
B013/08X08	€ 17,30	8 x 8 mm	200 mm	h13
B013/10X10	€ 24,20	10 x 10 mm	200 mm	h13
B013/12X12	€ 28,50	12 x 12 mm	200 mm	h13
B013/14X14	€ 39,90	14 x 14 mm	200 mm	h13
B013/16X16	€ 45,80	16 x 16 mm	200 mm	h13
B013/20X20	€ 67,70	20 x 20 mm	200 mm	h13

B014-

BARRETTE TRATTATE E RETTIFICATE



HSS
CO 8%







Tornio

Art.	€	Dimensioni lati	Lunghezza	Tolleranza
B014/20X04	€ 24,60	20 x 04 mm	200 mm	h13
B014/20X05	€ 26,40	20 x 05 mm	200 mm	h13
B014/20X06	€ 39,60	20 x 06 mm	200 mm	h13
B014/20X08	€ 50,20	20 x 08 mm	200 mm	h13
B014/20X10	€ 53,30	20 x 10 mm	200 mm	h13
B014/20X12	€ 53,30	20 x 12 mm	200 mm	h13
B014/25X06	€ 38,50	25 x 06 mm	200 mm	h13



TIPOLOGIE DEL MATERIALE DI COSTRUZIONE DELLE PUNTE ELICOIDALI

Tipologia	Prodotto	Descrizione	Durata	Metalli lavorabili
HSS	 ST1Ax	HSS, High Speed Steel, cioè acciaio rapido, è il più comune tra tutti gli acciai per la realizzazione di utensili per metalli. Un utensile in HSS possiede una durezza elevata e una buona resistenza.	**	Acciai legati e non legati, metalli non ferrosi, ghisa grigia e malleabile, ferro sinterizzato
	 P023-			
	 ST2Ax			
HSS-TiN	 P058-	Il rivestimento di titanio, effettuato ad un utensile in HSS forma una lega più dura e più resistente. Questo porta ad avere una punta in grado di lavorare gli stessi materiali di quella in HSS ma con una usura del tagliente molto ridotta.	****	Acciai legati e non legati, metalli non ferrosi, ghisa malleabile, ferro sinterizzato
HSS-Co5%	 P065-	Il cobalto, aggiunto ad una utensile in acciaio come un HSS - in questo caso il 5% - conferisce solidità e resistenza ed aumenta la durezza dell'utensile stesso. Il cobalto mantiene le sue proprietà ad una temperatura più alta rispetto al titanio, il che rende possibile forare ad una velocità più elevata ed a condizioni più critiche.	*****	Acciai duri e trattati, acciai inossidabili, cromo nichel, ghisa e bronzo
HSS-Co8%	 P064-	Il cobalto, aggiunto ad una utensile in acciaio come un HSS - in questo caso il 8% - conferisce solidità e resistenza ed aumenta la durezza dell'utensile stesso. Il cobalto mantiene le sue proprietà ad una temperatura più alta rispetto al titanio, il che rende possibile forare ad una velocità più elevata ed a condizioni più critiche.	*****	Acciai duri e trattati, acciai inossidabili, cromo nichel, ghisa e bronzo

PARAMETRI FORATURA PER TIPOLOGIA DI MATERIALE PUNTE HSS, HSS-CO5% E HSS-CO8%

Materiale da lavorare	Tipo Punta	Velocità Periferica Vt (m/min)	Diametro punta				Refrigerante
			2	5	8	12	
			Avanzamento (mm/giro)				
Acciaio non legato da costruzione R<600N/mm2	HSS	20 - 25	0,05	0,12	0,20	0,25	Emulsione
	HSS-Tin	25 - 30					
Acciaio da costruzione basso legato R< 700÷900N/mm2	HSS	10 - 12	0,03	0,07	0,10	0,16	Emulsione
	HSS-Tin	15 - 18					
Acciaio legato R<1100÷1300N/mm2	HSS	6 - 8	0,02	0,05	0,08	0,12	Emulsione
	HSS-Tin	8 - 10					
Acciaio Inox	Hss-Co5%	6 - 8	0,02	0,05	0,08	0,12	Emulsione
	Hss-Co8%	8 - 10					
Ghisa Grigia 200HB	HSS	15 - 20	0,02	0,12	0,20	0,25	No refriger.
	HSS-Tin	20 - 25					
Ghisa Grigia 350HB	HSS	5 - 10	0,03	0,07	0,10	0,16	No refriger.
	HSS-Tin	20 - 25					
Bronzo	HSS	20 - 30	0,05	0,08	0,14	0,20	Emulsione o Olio
Ottone	HSS	40 - 70	0,06	0,16	0,22	0,32	
Alluminio	HSS	40 - 80	0,05	0,14	0,18	0,22	Emulsione
Leghe di Alluminio	HSS	30 - 60	0,05	0,14	0,18	0,22	



NUMERI DI GIRI AL MINUTO TEORICI PER L'UTILIZZO DELLE PUNTE ELICOIDALI IN BASE ALLA V_t SCELTA

Ø Punta	Velocità di taglio V_t (mt/min)																	
	3	4	5	6	8	10	12	15	18	20	25	30	35	40	50	60	70	80
(mm)	Numero di giri al minuto (rpm)																	
2	478	637	796	955	1274	1592	1911	2389	2866	3185	3981	4777	5573	6369	7962	9554	11146	12739
3	318	425	531	637	849	1062	1274	1592	1911	2123	2654	3185	3715	4246	5308	6369	7431	8493
4	239	318	398	478	637	796	955	1194	1433	1592	1990	2389	2787	3185	3981	4777	5573	6369
5	191	255	318	382	510	637	764	955	1146	1274	1592	1911	2229	2548	3185	3822	4459	5096
6	159	212	265	318	425	531	637	796	955	1062	1327	1592	1858	2123	2654	3185	3715	4246
8	119	159	199	239	318	398	478	597	717	796	995	1194	1393	1592	1990	2389	2787	3185
10	96	127	159	191	255	318	382	478	573	637	796	955	1115	1274	1592	1911	2229	2548
12	80	106	133	159	212	265	318	398	478	531	663	796	929	1062	1327	1592	1858	2123



ST1AX

PUNTA CILINDRICA ELICOIDALE

DIN 338/N, destra, rullata, nera

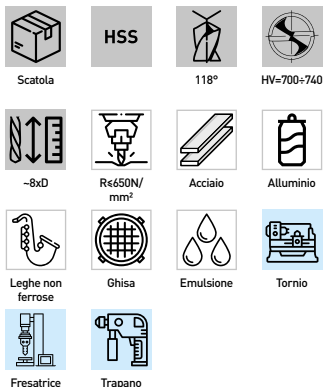

Art.	€	ø	L	l	Pack
ST1A01	€ 0,43	1,00 mm	34 mm	12 mm	10
ST1A01.25	€ 0,43	1,25 mm	38 mm	16 mm	10
ST1A01.50	€ 0,43	1,50 mm	40 mm	18 mm	10
ST1A01.75	€ 0,43	1,75 mm	46 mm	22 mm	10
ST1A02	€ 0,43	2,00 mm	49 mm	24 mm	10
ST1A02.25	€ 0,43	2,25 mm	53 mm	27 mm	10
ST1A02.50	€ 0,43	2,50 mm	57 mm	30 mm	10
ST1A02.75	€ 0,43	2,75 mm	61 mm	33 mm	10
ST1A03	€ 0,43	3,00 mm	61 mm	33 mm	10
ST1A03.25	€ 0,48	3,25 mm	65 mm	36 mm	10
ST1A03.50	€ 0,48	3,50 mm	70 mm	39 mm	10
ST1A03.75	€ 0,48	3,75 mm	70 mm	39 mm	10
ST1A04	€ 0,48	4,00 mm	75 mm	43 mm	10
ST1A04.25	€ 0,56	4,25 mm	75 mm	43 mm	10
ST1A04.50	€ 0,56	4,50 mm	80 mm	47 mm	10
ST1A04.75	€ 0,56	4,75 mm	80 mm	47 mm	10
ST1A05	€ 0,63	5,00 mm	86 mm	52 mm	10
ST1A05.25	€ 0,63	5,25 mm	86 mm	52 mm	10
ST1A05.50	€ 0,63	5,50 mm	93 mm	57 mm	10
ST1A05.75	€ 0,72	5,75 mm	93 mm	57 mm	10
ST1A06	€ 0,72	6,00 mm	93 mm	57 mm	10
ST1A06.25	€ 0,82	6,25 mm	101 mm	63 mm	10
ST1A06.50	€ 0,82	6,50 mm	101 mm	63 mm	10
ST1A06.75	€ 1,09	6,75 mm	109 mm	69 mm	10
ST1A07	€ 1,09	7,00 mm	109 mm	69 mm	10
ST1A07.25	€ 1,09	7,25 mm	109 mm	69 mm	10
ST1A07.50	€ 1,19	7,50 mm	109 mm	69 mm	10
ST1A07.75	€ 1,27	7,75 mm	117 mm	75 mm	10
ST1A08	€ 1,27	8,00 mm	117 mm	75 mm	10
ST1A08.25	€ 1,46	8,25 mm	117 mm	75 mm	5
ST1A08.50	€ 1,46	8,50 mm	117 mm	75 mm	5
ST1A08.75	€ 1,62	8,75 mm	125 mm	81 mm	5
ST1A09	€ 1,62	9,00 mm	125 mm	81 mm	5
ST1A09.25	€ 1,80	9,25 mm	125 mm	81 mm	5
ST1A09.50	€ 1,80	9,50 mm	125 mm	81 mm	5
ST1A09.75	€ 1,90	9,75 mm	133 mm	87 mm	5
ST1A10	€ 1,99	10,00 mm	133 mm	87 mm	5
ST1A10.25	€ 2,36	10,25 mm	133 mm	87 mm	5
ST1A10.50	€ 2,36	10,50 mm	133 mm	87 mm	5
ST1A10.75	€ 2,70	10,75 mm	142 mm	94 mm	5
ST1A11	€ 2,70	11,00 mm	142 mm	94 mm	5
ST1A11.25	€ 3,07	11,25 mm	142 mm	94 mm	5
ST1A11.50	€ 3,07	11,50 mm	142 mm	94 mm	5
ST1A11.75	€ 3,43	11,75 mm	142 mm	94 mm	5
ST1A12	€ 3,43	12,00 mm	151 mm	101 mm	5
ST1A12.25	€ 3,89	12,25 mm	151 mm	101 mm	5
ST1A12.50	€ 3,89	12,50 mm	151 mm	101 mm	5
ST1A12.75	€ 3,89	12,75 mm	151 mm	101 mm	5
ST1A13	€ 3,89	13,00 mm	151 mm	101 mm	5

P046

€ 31,30

SERIE PUNTE

DIN 338/N, destra, rullate, nere.



Misura (progressione 0,5 mm) 1 + 13 mm

P045

€ 15,80

SERIE PUNTE

DIN 338/N, destra, rullate, nere.



Misura (progressione 0,5 mm) 1+10 mm

ST1AXC

PUNTA CILINDRICA ELICOIDALE

DIN 1897/N, destra, serie corta, rullata, nera

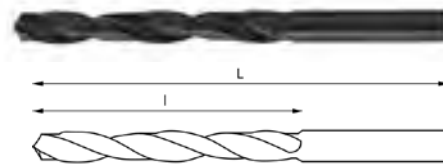
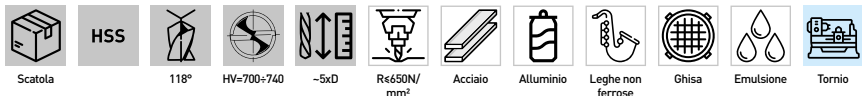

Art.	€	ø	L	l	Pack
ST1A02.00C	€ 0,31	2,00 mm	38 mm	12 mm	10
ST1A02.50C	€ 0,31	2,50 mm	43 mm	14 mm	10
ST1A03.00C	€ 0,31	3,00 mm	46 mm	16 mm	10
ST1A03.25C	€ 0,36	3,25 mm	49 mm	18 mm	10
ST1A03.50C	€ 0,36	3,50 mm	52 mm	20 mm	10
ST1A03.75C	€ 0,40	3,75 mm	52 mm	20 mm	10
ST1A04.00C	€ 0,40	4,00 mm	55 mm	22 mm	10
ST1A04.25C	€ 0,43	4,25 mm	55 mm	22 mm	10
ST1A04.50C	€ 0,43	4,50 mm	58 mm	24 mm	10
ST1A05.00C	€ 0,52	5,00 mm	62 mm	26 mm	10
ST1A05.50C	€ 0,71	5,50 mm	66 mm	28 mm	10
ST1A06.00C	€ 0,71	6,00 mm	66 mm	28 mm	10



ST1AXR10

PUNTA CILINDRICA ELICOIDALE

DIN 338/N,destra, rullata, nera, con gambo ridotto a 10 mm

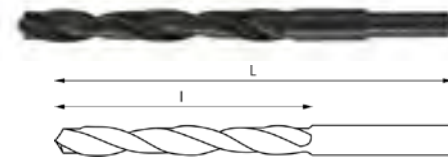
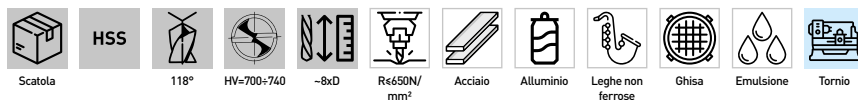

Art.	€	Ø	L	l	Pack
ST1A10.25R10	€ 2,53	10,25 mm	133 mm	87 mm	5
ST1A10.50R10	€ 2,53	10,5 mm	133 mm	87 mm	5
ST1A10.75R10	€ 2,86	10,75 mm	142 mm	94 mm	5
ST1A11.00R10	€ 2,86	11,00 mm	142 mm	94 mm	5
ST1A11.25R10	€ 3,28	11,25 mm	142 mm	94 mm	5
ST1A11.50R10	€ 3,28	11,5 mm	142 mm	94 mm	5
ST1A11.75R10	€ 3,70	11,75 mm	142 mm	94 mm	5
ST1A12.00R10	€ 3,70	12 mm	151 mm	101 mm	5
ST1A12.25R10	€ 4,12	12,25 mm	151 mm	101 mm	5
ST1A12.50R10	€ 4,12	12,50 mm	151 mm	101 mm	5
ST1A12.75R10	€ 4,12	12,75 mm	151 mm	101 mm	5
ST1A13.00R10	€ 4,12	13 mm	151 mm	101 mm	5
ST1A13.25R10	€ 5,20	13,25 mm	160 mm	108 mm	5
ST1A13.50R10	€ 5,20	13,5 mm	160 mm	108 mm	5
ST1A13.75R10	€ 5,20	13,75 mm	160 mm	108 mm	5
ST1A14.00R10	€ 5,20	14,00 mm	160 mm	108 mm	5
ST1A14.25R10	€ 5,70	14,25 mm	169 mm	114 mm	5
ST1A14.50R10	€ 5,70	14,5 mm	169 mm	114 mm	5
ST1A14.75R10	€ 5,70	14,75 mm	169 mm	114 mm	5
ST1A15.00R10	€ 5,70	15 mm	169 mm	114 mm	5
ST1A15.25R10	€ 7,00	15,25 mm	178 mm	120 mm	5
ST1A15.50R10	€ 7,00	15,50 mm	178 mm	120 mm	5
ST1A15.75R10	€ 7,00	15,75 mm	178 mm	120 mm	5
ST1A16.00R10	€ 7,00	16 mm	178 mm	120 mm	5

ST1AXR13

PUNTA CILINDRICA ELICOIDALE

DIN 338/N,destra, rullata, nera, con gambo ridotto a 13 mm

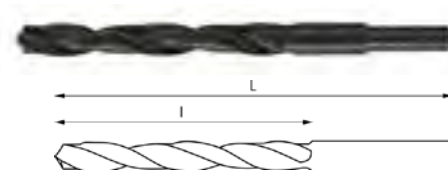
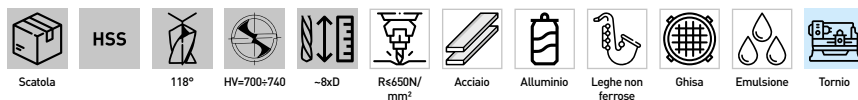

Art.	€	Ø	L	l	Pack
ST1A13.25R13	€ 5,20	13,25 mm	160 mm	108 mm	5
ST1A13.50R13	€ 5,20	13,50 mm	160 mm	108 mm	5
ST1A13.75R13	€ 5,20	13,75 mm	160 mm	108 mm	5
ST1A14.00R13	€ 5,20	14,00 mm	160 mm	108 mm	5
ST1A14.25R13	€ 5,70	14,25 mm	169 mm	114 mm	5
ST1A14.50R13	€ 5,70	14,50 mm	169 mm	114 mm	5
ST1A14.75R13	€ 5,70	14,75 mm	169 mm	114 mm	5
ST1A15.00R13	€ 5,70	15,00 mm	169 mm	114 mm	5
ST1A15.25R13	€ 7,00	15,25 mm	178 mm	120 mm	5
ST1A15.50R13	€ 7,00	15,50 mm	178 mm	120 mm	5
ST1A15.75R13	€ 7,00	15,75 mm	178 mm	120 mm	5
ST1A16.00R13	€ 7,00	16,00 mm	178 mm	120 mm	5

P023-

PUNTA ELICOIDALE CILINDRICA

DIN 338/N, Destra, rettificata

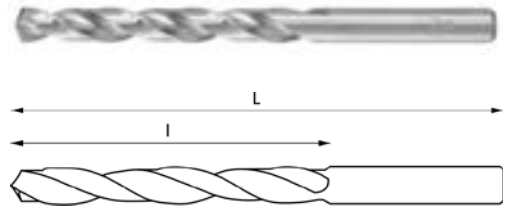
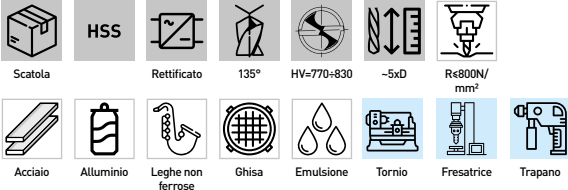

Art.	€	Ø	L	l	Pack	Art.	€	Ø	L	l	Pack	Art.	€	Ø	L	l	Pack
P023/00.30	€ 0,39	0.30 mm	19 mm	3 mm	10	P023/03.80	€ 0,85	3.80 mm	75 mm	43 mm	10	P023/07.80	€ 2,42	7.80 mm	117 mm	75 mm	10
P023/00.35	€ 0,39	0.35 mm	19 mm	4 mm	10	P023/03.90	€ 0,85	3.90 mm	75 mm	43 mm	10	P023/07.90	€ 2,42	7.90 mm	117 mm	75 mm	10
P023/00.40	€ 0,39	0.40 mm	20 mm	5 mm	10	P023/04.00	€ 0,99	4.00 mm	75 mm	43 mm	10	P023/08.00	€ 3,20	8.00 mm	117 mm	75 mm	5
P023/00.45	€ 0,39	0.45 mm	20 mm	5 mm	10	P023/04.10	€ 0,93	4.10 mm	75 mm	43 mm	10	P023/08.10	€ 2,75	8.10 mm	117 mm	75 mm	5
P023/00.50	€ 0,39	0.50 mm	22 mm	6 mm	10	P023/04.20	€ 0,93	4.20 mm	75 mm	43 mm	10	P023/08.20	€ 2,75	8.20 mm	117 mm	75 mm	5
P023/00.55	€ 0,39	0.55 mm	24 mm	7 mm	10	P023/04.25	€ 1,35	4.25 mm	75 mm	43 mm	10	P023/08.25	€ 4,09	8.25 mm	117 mm	75 mm	5
P023/00.60	€ 0,39	0.60 mm	24 mm	7 mm	10	P023/04.30	€ 0,99	4.30 mm	80 mm	47 mm	10	P023/08.30	€ 2,75	8.30 mm	117 mm	75 mm	5
P023/00.65	€ 0,39	0.65 mm	26 mm	8 mm	10	P023/04.40	€ 0,99	4.40 mm	80 mm	47 mm	10	P023/08.40	€ 2,75	8.40 mm	117 mm	75 mm	5
P023/00.70	€ 0,39	0.70 mm	28 mm	9 mm	10	P023/04.50	€ 1,17	4.50 mm	80 mm	47 mm	10	P023/08.50	€ 4,02	8.50 mm	117 mm	75 mm	5
P023/00.75	€ 0,39	0.75 mm	28 mm	9 mm	10	P023/04.60	€ 1,16	4.60 mm	80 mm	47 mm	10	P023/08.60	€ 3,19	8.60 mm	125 mm	81 mm	5
P023/00.80	€ 0,39	0.80 mm	30 mm	10 mm	10	P023/04.70	€ 1,16	4.70 mm	80 mm	47 mm	10	P023/08.70	€ 3,19	8.70 mm	125 mm	81 mm	5
P023/00.85	€ 0,39	0.85 mm	30 mm	10 mm	10	P023/04.75	€ 1,35	4.75 mm	80 mm	47 mm	10	P023/08.75	€ 4,37	8.75 mm	125 mm	81 mm	5
P023/00.90	€ 0,39	0.90 mm	32 mm	11 mm	10	P023/04.80	€ 1,16	4.80 mm	86 mm	52 mm	10	P023/08.80	€ 3,19	8.80 mm	125 mm	81 mm	5
P023/00.95	€ 0,39	0.95 mm	32 mm	11 mm	10	P023/04.90	€ 1,16	4.90 mm	86 mm	52 mm	10	P023/08.90	€ 3,19	8.90 mm	125 mm	81 mm	5
P023/01.00	€ 0,89	1.00 mm	34 mm	12 mm	10	P023/05.00	€ 1,25	5.00 mm	86 mm	52 mm	10	P023/09.00	€ 4,19	9.00 mm	125 mm	81 mm	5
P023/01.10	€ 0,47	1.10 mm	36 mm	14 mm	10	P023/05.10	€ 1,44	5.10 mm	86 mm	52 mm	10	P023/09.10	€ 3,53	9.10 mm	125 mm	81 mm	5
P023/01.20	€ 0,47	1.20 mm	38 mm	16 mm	10	P023/05.20	€ 1,44	5.20 mm	86 mm	52 mm	10	P023/09.20	€ 3,53	9.20 mm	125 mm	81 mm	5
P023/01.25	€ 0,89	1.25 mm	38 mm	16 mm	10	P023/05.25	€ 1,70	5.25 mm	86 mm	52 mm	10	P023/09.25	€ 4,91	9.25 mm	125 mm	81 mm	5
P023/01.30	€ 0,47	1.30 mm	38 mm	16 mm	10	P023/05.30	€ 1,44	5.30 mm	86 mm	52 mm	10	P023/09.30	€ 3,53	9.30 mm	125 mm	81 mm	5
P023/01.40	€ 0,47	1.40 mm	40 mm	18 mm	10	P023/05.40	€ 1,44	5.40 mm	93 mm	57 mm	10	P023/09.40	€ 3,53	9.40 mm	125 mm	81 mm	5
P023/01.50	€ 0,81	1.50 mm	40 mm	18 mm	10	P023/05.50	€ 1,60	5.50 mm	93 mm	57 mm	10	P023/09.50	€ 4,45	9.50 mm	125 mm	81 mm	5
P023/01.60	€ 0,52	1.60 mm	43 mm	20 mm	10	P023/05.60	€ 1,51	5.60 mm	93 mm	57 mm	10	P023/09.60	€ 3,95	9.60 mm	133 mm	87 mm	5
P023/01.70	€ 0,52	1.70 mm	43 mm	20 mm	10	P023/05.70	€ 1,51	5.70 mm	93 mm	57 mm	10	P023/09.70	€ 3,95	9.70 mm	133 mm	87 mm	5
P023/01.75	€ 0,71	1.75 mm	46 mm	22 mm	10	P023/05.75	€ 1,88	5.75 mm	93 mm	57 mm	10	P023/09.75	€ 5,30	9.75 mm	133 mm	87 mm	5
P023/01.80	€ 0,52	1.80 mm	46 mm	22 mm	10	P023/05.80	€ 1,51	5.80 mm	93 mm	57 mm	10	P023/09.80	€ 3,95	9.80 mm	133 mm	87 mm	5
P023/01.90	€ 0,52	1.90 mm	46 mm	22 mm	10	P023/05.90	€ 1,51	5.90 mm	93 mm	57 mm	10	P023/09.90	€ 3,95	9.90 mm	133 mm	87 mm	5
P023/02.00	€ 0,71	2.00 mm	49 mm	24 mm	10	P023/06.00	€ 1,70	6.00 mm	93 mm	57 mm	10	P023/10.00	€ 4,81	10.00 mm	133 mm	87 mm	5
P023/02.10	€ 0,57	2.10 mm	49 mm	24 mm	10	P023/06.10	€ 1,56	6.10 mm	101 mm	63 mm	10	P023/10.25	€ 6,70	10.25 mm	133 mm	87 mm	5
P023/02.20	€ 0,57	2.20 mm	53 mm	27 mm	10	P023/06.20	€ 1,56	6.20 mm	101 mm	63 mm	10	P023/10.30	€ 4,94	10.30 mm	133 mm	87 mm	5
P023/02.25	€ 0,81	2.25 mm	53 mm	27 mm	10	P023/06.25	€ 2,41	6.25 mm	101 mm	63 mm	10	P023/10.40	€ 4,94	10.40 mm	133 mm	87 mm	5
P023/02.30	€ 0,57	2.30 mm	53 mm	27 mm	10	P023/06.30	€ 1,56	6.30 mm	101 mm	63 mm	10	P023/10.50	€ 5,90	10.50 mm	133 mm	87 mm	5
P023/02.40	€ 0,57	2.40 mm	57 mm	30 mm	10	P023/06.40	€ 1,56	6.40 mm	101 mm	63 mm	10	P023/10.75	€ 8,10	10.75 mm	142 mm	94 mm	5
P023/02.50	€ 0,71	2.50 mm	57 mm	30 mm	10	P023/06.50	€ 2,14	6.50 mm	101 mm	63 mm	10	P023/11.00	€ 7,00	11.00 mm	142 mm	94 mm	5
P023/02.60	€ 0,68	2.60 mm	57 mm	30 mm	10	P023/06.60	€ 1,89	6.60 mm	101 mm	63 mm	10	P023/11.25	€ 8,50	11.25 mm	142 mm	94 mm	5
P023/02.70	€ 0,68	2.70 mm	61 mm	33 mm	10	P023/06.70	€ 1,89	6.70 mm	101 mm	63 mm	10	P023/11.40	€ 6,20	11.40 mm	142 mm	94 mm	5
P023/02.75	€ 0,89	2.75 mm	61 mm	33 mm	10	P023/06.75	€ 2,77	6.75 mm	109 mm	69 mm	10	P023/11.50	€ 7,40	11.50 mm	142 mm	94 mm	5
P023/02.80	€ 0,68	2.80 mm	61 mm	33 mm	10	P023/06.80	€ 1,89	6.80 mm	109 mm	69 mm	10	P023/11.75	€ 9,30	11.75 mm	142 mm	94 mm	5
P023/02.90	€ 0,68	2.90 mm	61 mm	33 mm	10	P023/06.90	€ 1,89	6.90 mm	109 mm	69 mm	10	P023/11.75	€ 9,30	11.75 mm	142 mm	94 mm	5
P023/03.00	€ 0,81	3.00 mm	61 mm	33 mm	10	P023/07.00	€ 2,59	7.00 mm	109 mm	69 mm	10	P023/12.00	€ 8,10	12.00 mm	151 mm	101 mm	5
P023/03.10	€ 0,81	3.10 mm	65 mm	36 mm	10	P023/07.10	€ 2,16	7.10 mm	109 mm	69 mm	10	P023/12.25	€ 10,10	12.25 mm	151 mm	101 mm	5
P023/03.20	€ 0,81	3.20 mm	65 mm	36 mm	10	P023/07.20	€ 2,16	7.20 mm	109 mm	69 mm	10	P023/12.30	€ 7,60	12.30 mm	151 mm	101 mm	5
P023/03.25	€ 0,99	3.25 mm	65 mm	36 mm	10	P023/07.25	€ 3,03	7.25 mm	109 mm	69 mm	10	P023/12.40	€ 7,60	12.40 mm	151 mm	101 mm	5
P023/03.30	€ 0,89	3.30 mm	65 mm	36 mm	10	P023/07.30	€ 2,16	7.30 mm	109 mm	69 mm	10	P023/12.50	€ 8,80	12.50 mm	151 mm	101 mm	5
P023/03.40	€ 0,89	3.40 mm	70 mm	39 mm	10	P023/07.40	€ 2,16	7.40 mm	109 mm	69 mm	10	P023/12.75	€ 11,40	12.75 mm	151 mm	101 mm	5
P023/03.50	€ 0,89	3.50 mm	70 mm	39 mm	10	P023/07.50	€ 2,67	7.50 mm	109 mm	69 mm	10	P023/13.00	€ 9,50	13.00 mm	151 mm	101 mm	5
P023/03.60	€ 0,85	3.60 mm	70 mm	39 mm	10	P023/07.60	€ 2,42	7.60 mm	117 mm	75 mm	10	P023/14.30	€ 15,30	14.30 mm	165 mm	115 mm	5
P023/03.70	€ 0,85	3.70 mm	70 mm	39 mm	10	P023/07.70	€ 2,42	7.70 mm	117 mm	75 mm	10	P023/14.40	€ 15,30	14.40 mm	165 mm	115 mm	5
P023/03.75	€ 1,07	3.75 mm	70 mm	39 mm	10	P023/07.75	€ 3,38	7.75 mm	117 mm	75 mm	10	P023/16.40	€ 19,80	16.40 mm	170 mm	115 mm	5

P023/19

€ 36,20

SERIE PUNTE ELICOIDALI CILINDRICHE

DIN 338/N, Destra, rettificata



19 Pcs

Misura (progressione 0,5 mm) 1 ÷ 10 mm



P023/25

€ 73,40

SERIE PUNTE ELICOIDALI CILINDRICHE

DIN 338/N, Destra, rettificata



25 Pcs

Misura (progressione 0,5 mm) 1 ÷ 13 mm





P023-XC

PUNTA ELICOIDALE CILINDRICA SERIE CORTA

DIN 1897/N, Destra, rettificata

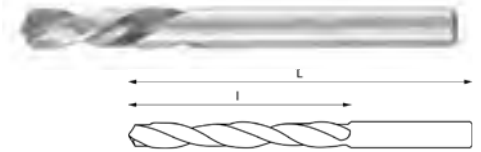

Art.	€	Ø	L	l	Pack
P023/03.00C	€ 0,89	3,00 mm	46 mm	16 mm	10
P023/03.25C	€ 0,99	3,25 mm	49 mm	18 mm	10
P023/03.50C	€ 0,99	3,50 mm	52 mm	20 mm	10
P023/03.75C	€ 1,07	3,75 mm	52 mm	20 mm	10
P023/04.00C	€ 1,07	4,00 mm	55 mm	22 mm	10

Art.	€	Ø	L	l	Pack
P023/04.25C	€ 1,42	4,25 mm	55 mm	22 mm	10
P023/04.50C	€ 1,25	4,50 mm	58 mm	24 mm	10
P023/05.00C	€ 1,35	5,00 mm	62 mm	26 mm	10
P023/05.50C	€ 1,78	5,50 mm	66 mm	28 mm	10
P023/06.00C	€ 1,88	6,00 mm	66 mm	28 mm	10

P023-XL

PUNTA ELICOIDALE CILINDRICA LUNGA

DIN 340, Destra, rettificata

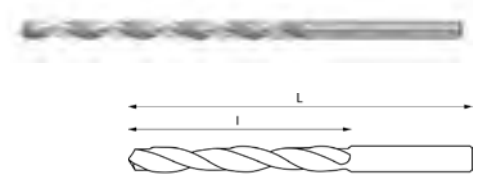

Art.	€	Ø	L	l	Pack
P023/01.00L	€ 0,99	1,00 mm	56 mm	33 mm	10
P023/01.25L	€ 0,99	1,25 mm	65 mm	40 mm	10
P023/01.50L	€ 0,99	1,50 mm	70 mm	45 mm	10
P023/01.75L	€ 0,99	1,75 mm	80 mm	53 mm	10
P023/02.00L	€ 0,89	2,00 mm	85 mm	56 mm	10
P023/02.25L	€ 0,99	2,25 mm	90 mm	59 mm	10
P023/02.50L	€ 0,89	2,50 mm	95 mm	62 mm	10
P023/02.75L	€ 1,07	2,75 mm	100 mm	66 mm	10
P023/03.00L	€ 0,99	3,00 mm	100 mm	66 mm	10
P023/03.25L	€ 1,07	3,25 mm	106 mm	69 mm	10
P023/03.50L	€ 1,07	3,50 mm	112 mm	73 mm	10
P023/03.75L	€ 1,25	3,75 mm	112 mm	73 mm	10
P023/04.00L	€ 1,17	4,00 mm	119 mm	78 mm	10
P023/04.25L	€ 1,35	4,25 mm	119 mm	78 mm	10
P023/04.50L	€ 1,35	4,50 mm	126 mm	82 mm	10
P023/04.75L	€ 1,60	4,75 mm	126 mm	82 mm	10
P023/05.00L	€ 1,60	5,00 mm	132 mm	87 mm	10
P023/05.25L	€ 1,96	5,25 mm	132 mm	87 mm	10
P023/05.50L	€ 1,96	5,50 mm	139 mm	91 mm	10
P023/05.75L	€ 2,14	5,75 mm	139 mm	91 mm	10
P023/06.00L	€ 2,14	6,00 mm	139 mm	91 mm	10
P023/06.25L	€ 2,67	6,25 mm	148 mm	97 mm	10

Art.	€	Ø	L	l	Pack
P023/06.50L	€ 2,67	6,50 mm	148 mm	97 mm	10
P023/06.75L	€ 2,77	6,75 mm	148 mm	97 mm	10
P023/07.00L	€ 2,77	7,00 mm	156 mm	102 mm	10
P023/07.25L	€ 3,20	7,25 mm	156 mm	102 mm	10
P023/07.50L	€ 3,20	7,25 mm	156 mm	102 mm	10
P023/07.75L	€ 3,84	7,75 mm	165 mm	109 mm	10
P023/08.00L	€ 3,66	8,00 mm	165 mm	109 mm	5
P023/08.25L	€ 5,20	8,25 mm	165 mm	109 mm	5
P023/08.50L	€ 5,20	8,50 mm	165 mm	109 mm	5
P023/08.75L	€ 5,30	8,75 mm	175 mm	115 mm	5
P023/09.00L	€ 5,30	9,00 mm	175 mm	115 mm	5
P023/09.25L	€ 6,10	9,25 mm	175 mm	115 mm	5
P023/09.50L	€ 6,10	9,50 mm	175 mm	115 mm	5
P023/09.75L	€ 6,10	9,75 mm	184 mm	121 mm	5
P023/10.00L	€ 6,10	10,00 mm	184 mm	121 mm	5
P023/10.25L	€ 8,40	10,25 mm	184 mm	121 mm	5
P023/10.50L	€ 8,40	10,50 mm	184 mm	121 mm	5
P023/11.00L	€ 9,90	11,00 mm	195 mm	128 mm	5
P023/11.50L	€ 10,70	11,50 mm	195 mm	128 mm	5
P023/12.00L	€ 12,50	12,00 mm	205 mm	134 mm	5
P023/12.50L	€ 13,80	12,50 mm	205 mm	134 mm	5
P023/13.00L	€ 14,50	13,00 mm	205 mm	134 mm	5

P023-XL1

PUNTA ELICOIDALE CILINDRICA SERIE EXTRA LUNGA

DIN 1869-1, Destra, rettificata



Art.	€	Ø	L	l
P023/02.00L1	€ 1,60	02,00 mm	125 mm	85 mm
P023/02.50L1	€ 1,78	02,50 mm	140 mm	95 mm
P023/03.00L1	€ 2,24	03,00 mm	150 mm	100 mm
P023/03.50L1	€ 2,67	03,50 mm	165 mm	115 mm
P023/04.00L1	€ 3,56	04,00 mm	175 mm	120 mm
P023/04.50L1	€ 4,45	04,50 mm	185 mm	125 mm
P023/05.00L1	€ 5,30	05,00 mm	195 mm	135 mm
P023/05.50L1	€ 6,30	05,50 mm	205 mm	140 mm
P023/06.00L1	€ 8,10	06,00 mm	205 mm	140 mm
P023/06.50L1	€ 8,90	06,50 mm	215 mm	150 mm
P023/07.00L1	€ 10,70	07,00 mm	225 mm	155 mm
P023/07.50L1	€ 11,60	07,50 mm	225 mm	155 mm

Art.	€	Ø	L	l
P023/08.00L1	€ 14,30	08,00 mm	240 mm	165 mm
P023/08.50L1	€ 16,00	08,50 mm	240 mm	165 mm
P023/09.00L1	€ 17,80	09,00 mm	250 mm	175 mm
P023/09.50L1	€ 19,60	09,50 mm	250 mm	175 mm
P023/10.00L1	€ 22,30	10,00 mm	265 mm	185 mm
P023/10.50L1	€ 24,10	10,50 mm	265 mm	185 mm
P023/11.00L1	€ 26,70	11,00 mm	280 mm	195 mm
P023/11.50L1	€ 29,50	11,50 mm	280 mm	195 mm
P023/12.00L1	€ 31,20	12,00 mm	295 mm	205 mm
P023/12.50L1	€ 33,00	12,50 mm	295 mm	205 mm
P023/13.00L1	€ 34,80	13,00 mm	295 mm	205 mm

P023-XL2
PUNTA ELICOIDALE CILINDRICA SERIE EXTRA LUNGA

DIN 1869-2, Destra, rettificata



Art.	€	Ø	L	l
P023/02.00L2	€ 2,24	02,00 mm	160 mm	110 mm
P023/02.50L2	€ 2,67	02,50 mm	180 mm	120 mm
P023/03.00L2	€ 3,20	03,00 mm	190 mm	130 mm
P023/03.50L2	€ 3,56	03,50 mm	210 mm	145 mm
P023/04.00L2	€ 5,30	04,00 mm	220 mm	150 mm
P023/04.50L2	€ 6,30	04,50 mm	235 mm	160 mm
P023/05.00L2	€ 8,10	05,00 mm	245 mm	170 mm
P023/05.50L2	€ 8,90	05,50 mm	260 mm	180 mm
P023/06.00L2	€ 10,70	06,00 mm	260 mm	180 mm
P023/06.50L2	€ 12,50	06,50 mm	275 mm	190 mm
P023/07.00L2	€ 15,20	07,00 mm	290 mm	200 mm
P023/07.50L2	€ 16,00	07,50 mm	290 mm	200 mm
P023/08.00L2	€ 19,60	08,00 mm	305 mm	210 mm
P023/08.50L2	€ 21,40	08,50 mm	305 mm	210 mm
P023/09.00L2	€ 24,10	09,00 mm	320 mm	220 mm
P023/09.50L2	€ 24,90	09,50 mm	320 mm	220 mm
P023/10.00L2	€ 30,30	10,00 mm	340 mm	235 mm
P023/10.50L2	€ 32,10	10,50 mm	340 mm	235 mm
P023/11.00L2	€ 37,40	11,00 mm	365 mm	250 mm
P023/11.50L2	€ 40,10	11,50 mm	365 mm	250 mm
P023/12.00L2	€ 41,90	12,00 mm	375 mm	260 mm
P023/12.50L2	€ 44,50	12,50 mm	375 mm	260 mm
P023/13.00L2	€ 49,00	13,00 mm	375 mm	260 mm

P023-XL3
PUNTA ELICOIDALE CILINDRICA SERIE EXTRA LUNGA

DIN 1869-3, destra, rettificata

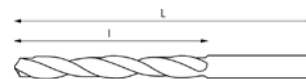

Art.	€	Ø	L	l
P023/02.00L3	€ 2,67	02,00 mm	200 mm	135 mm
P023/02.50L3	€ 3,13	02,50 mm	225 mm	150 mm
P023/03.00L3	€ 3,56	03,00 mm	240 mm	160 mm
P023/03.50L3	€ 5,30	03,50 mm	265 mm	180 mm
P023/04.00L3	€ 6,30	04,00 mm	280 mm	190 mm
P023/04.50L3	€ 8,10	04,50 mm	295 mm	200 mm
P023/05.00L3	€ 9,90	05,00 mm	315 mm	210 mm
P023/05.50L3	€ 11,60	05,50 mm	330 mm	225 mm
P023/06.00L3	€ 13,40	06,00 mm	330 mm	225 mm
P023/06.50L3	€ 16,00	06,50 mm	350 mm	235 mm
P023/07.00L3	€ 19,60	07,00 mm	370 mm	250 mm
P023/07.50L3	€ 21,40	07,50 mm	370 mm	250 mm
P023/08.00L3	€ 24,90	08,00 mm	390 mm	265 mm
P023/08.50L3	€ 27,70	08,50 mm	390 mm	265 mm
P023/09.00L3	€ 32,10	09,00 mm	410 mm	280 mm
P023/09.50L3	€ 33,00	09,50 mm	410 mm	280 mm
P023/10.00L3	€ 38,40	10,00 mm	430 mm	295 mm
P023/10.50L3	€ 41,00	10,50 mm	430 mm	295 mm
P023/11.00L3	€ 44,50	11,00 mm	455 mm	310 mm
P023/11.50L3	€ 47,30	11,50 mm	455 mm	310 mm
P023/12.00L3	€ 53,40	12,00 mm	480 mm	330 mm
P023/12.50L3	€ 57,90	12,50 mm	480 mm	330 mm
P023/13.00L3	€ 61,50	13,00 mm	480 mm	330 mm



P058-

PUNTA CILINDRICA ELICOIDALE

DIN 338/N, Destra, Lunga durata grazie al rivestimento in titanio

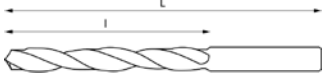

Art.	€	ø	L	l	Pack
P058/01.00	€ 0,72	1 mm	34 mm	12 mm	10
P058/01.25	€ 0,72	1,25 mm	38 mm	16 mm	10
P058/01.50	€ 0,72	1,50 mm	40 mm	18 mm	10
P058/01.75	€ 0,72	1,75 mm	46 mm	22 mm	10
P058/02.00	€ 0,82	2 mm	49 mm	24 mm	10
P058/02.25	€ 0,90	2,25 mm	53 mm	27 mm	10
P058/02.50	€ 0,90	2,50 mm	57 mm	30 mm	10
P058/02.75	€ 0,90	2,75 mm	61 mm	33 mm	10
P058/03.00	€ 0,90	3 mm	61 mm	33 mm	10
P058/03.25	€ 1,09	3,25 mm	65 mm	36 mm	10
P058/03.50	€ 1,09	3,50 mm	70 mm	39 mm	10
P058/03.75	€ 1,09	3,75 mm	70 mm	39 mm	10
P058/04.00	€ 1,09	4 mm	75 mm	43 mm	10
P058/04.25	€ 1,46	4,25 mm	75 mm	43 mm	10
P058/04.50	€ 1,46	4,50 mm	80 mm	47 mm	10
P058/04.75	€ 1,46	4,75 mm	80 mm	47 mm	10
P058/05.00	€ 1,46	5 mm	86 mm	52 mm	10
P058/05.25	€ 1,80	5,25 mm	86 mm	52 mm	10
P058/05.50	€ 1,80	5,50 mm	93 mm	57 mm	10
P058/05.75	€ 1,80	5,75 mm	93 mm	57 mm	10
P058/06.00	€ 1,80	6 mm	93 mm	57 mm	10
P058/06.25	€ 1,99	6,25 mm	101 mm	63 mm	10
P058/06.50	€ 1,99	6,50 mm	101 mm	63 mm	10
P058/06.75	€ 1,99	6,75 mm	109 mm	69 mm	10
P058/07.00	€ 1,99	7 mm	109 mm	69 mm	10
P058/07.25	€ 3,07	7,25 mm	109 mm	69 mm	10
P058/07.50	€ 3,07	7,50 mm	109 mm	69 mm	10
P058/07.75	€ 3,07	7,75 mm	117 mm	75 mm	10
P058/08.00	€ 3,07	8 mm	117 mm	75 mm	10
P058/08.25	€ 4,19	8,25 mm	117 mm	75 mm	5
P058/08.50	€ 4,19	8,50 mm	117 mm	75 mm	5
P058/08.75	€ 4,19	8,75 mm	125 mm	81 mm	5
P058/09.00	€ 4,19	9 mm	125 mm	81 mm	5
P058/09.25	€ 4,83	9,25 mm	125 mm	81 mm	5
P058/09.50	€ 4,83	9,50 mm	125 mm	81 mm	5
P058/09.75	€ 4,83	9,75 mm	133 mm	87 mm	5
P058/10.00	€ 4,83	10 mm	133 mm	87 mm	5
P058/10.25	€ 5,50	10,25 mm	133 mm	87 mm	5
P058/10.50	€ 5,50	10,50 mm	133 mm	87 mm	5
P058/10.75	€ 5,50	10,75 mm	142 mm	94 mm	5
P058/11.00	€ 5,50	11 mm	142 mm	94 mm	5
P058/11.25	€ 6,40	11,25 mm	142 mm	94 mm	5
P058/11.50	€ 6,40	11,50 mm	142 mm	94 mm	5
P058/11.75	€ 6,40	11,75 mm	142 mm	94 mm	5
P058/12.00	€ 6,40	12 mm	151 mm	101 mm	5
P058/12.25	€ 8,00	12,25 mm	151 mm	101 mm	5
P058/12.50	€ 8,00	12,50 mm	151 mm	101 mm	5
P058/12.75	€ 8,00	12,75 mm	151 mm	101 mm	5
P058/13.00	€ 8,00	13 mm	151 mm	101 mm	5

Scatola
 HSS
 Rettificato
 135°
 Acciaio
 Emulsione

TiN
 HV=740-780
 Alluminio
 Tornio
 -8xD
 Leghe non ferrose
 Fresatrice
 Re700N/mm²
 Ghisa
 Trapano

P058/170

€ 177,00

SERIE PUNTE

DIN 338/N, destra, lunga durata grazie al rivestimento in titanio.



150 (10x) Pz (progressione 0,5 mm) Ø 1 ÷ 8 mm
20 (5x) Pz (progressione 0,5 mm) Ø 8,5 ÷ 10 mm

P010/51

€ 61,00

SERIE PUNTE CILINDRICHE A DECIMI

DIN 338/N, destra, lunga durata grazie al rivestimento in titanio.



Misura (progressione 0,1 mm) 1 ÷ 6 mm

P010/41

€ 142,00

SERIE PUNTE CILINDRICHE A DECIMI

DIN 338/N, destra, lunga durata grazie al rivestimento in titanio.



Misura (progressione 0,1 mm) 6 ÷ 10 mm

P062

€ 67,20

SERIE PUNTE

DIN 338/N, Destra, Lunga durata grazie al rivestimento in titanio



Misura (progressione 0,5 mm) 1 ÷ 13 mm

P061

€ 37,60

SERIE PUNTE CILINDRICHE RETTIFICATE

DIN 338/N, destra, lunga durata grazie al rivestimento in titanio.



Misura (progressione 0,5 mm) 1 ÷ 10 mm

P068

€ 7,50

SERIE PUNTE

DIN 338/N, Destra, Lunga durata grazie al rivestimento in titanio



Misure x 1Pz 0.25 - 0.30 - 0.35 - 0.40 - 0.45 - 0.55 - 0.65 - 0.70 - 0.75 - 0.85 - 0.90 - 0.95 mm
Misure x 2 Pz 0.50 - 0.60 - 0.80 - 1.00 mm

P065-

PUNTA ELICOIDALE CILINDRICA AL COBALTO

DIN 338/N, autocentrante, destra, con grande resistenza termica

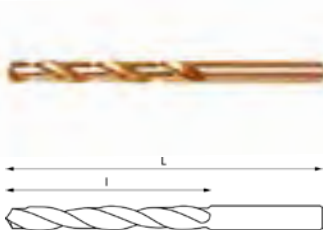

Art.	€	Ø	Lunghezza totale	Lunghezza elica	Pack
P065/01.00	€ 1,02	1 mm	34 mm	12 mm	10
P065/01.25	€ 1,23	1,25 mm	38 mm	16 mm	10
P065/01.50	€ 1,23	1,50 mm	40 mm	18 mm	10
P065/01.75	€ 1,23	1,75 mm	46 mm	22 mm	10
P065/02.00	€ 1,23	2 mm	49 mm	24 mm	10
P065/02.25	€ 1,42	2,25 mm	53 mm	27 mm	10
P065/02.50	€ 1,42	2,50 mm	57 mm	30 mm	10
P065/02.75	€ 1,42	2,75 mm	61 mm	33 mm	10
P065/03.00	€ 1,42	3 mm	61 mm	33 mm	10
P065/03.25	€ 1,95	3,25 mm	69 mm	39 mm	10
P065/03.50	€ 1,95	3,50 mm	70 mm	39 mm	10
P065/03.75	€ 1,95	3,75 mm	70 mm	39 mm	10
P065/04.00	€ 1,95	4 mm	75 mm	43 mm	10
P065/04.25	€ 2,75	4,25 mm	75 mm	43 mm	10
P065/04.50	€ 2,75	4,50 mm	80 mm	47 mm	10
P065/04.75	€ 2,75	4,75 mm	80 mm	47 mm	10
P065/05.00	€ 2,75	5 mm	86 mm	52 mm	10
P065/05.25	€ 3,46	5,25 mm	86 mm	52 mm	10
P065/05.50	€ 3,46	5,50 mm	93 mm	57 mm	10
P065/05.75	€ 3,46	5,75 mm	93 mm	57 mm	10
P065/06.00	€ 3,46	6 mm	93 mm	57 mm	10
P065/06.25	€ 4,27	6,25 mm	101 mm	63 mm	10
P065/06.50	€ 4,27	6,50 mm	101 mm	63 mm	10
P065/06.75	€ 4,27	6,75 mm	109 mm	69 mm	10
P065/07.00	€ 4,27	7 mm	109 mm	69 mm	10
P065/07.25	€ 7,40	7,25 mm	109 mm	69 mm	10
P065/07.50	€ 7,40	7,50 mm	109 mm	69 mm	10
P065/07.75	€ 7,40	7,75 mm	117 mm	75 mm	10
P065/08.00	€ 7,40	8 mm	117 mm	75 mm	5
P065/08.25	€ 9,10	8,25 mm	117 mm	75 mm	5
P065/08.50	€ 9,10	8,50 mm	117 mm	75 mm	5
P065/08.75	€ 9,10	8,75 mm	125 mm	81 mm	5
P065/09.00	€ 9,10	9 mm	125 mm	81 mm	5
P065/09.25	€ 11,50	9,25 mm	125 mm	81 mm	5
P065/09.50	€ 11,50	9,50 mm	125 mm	81 mm	5
P065/09.75	€ 11,50	9,75 mm	133 mm	87 mm	5
P065/10.00	€ 11,50	10 mm	133 mm	87 mm	5
P065/10.25	€ 13,80	10,25 mm	133 mm	87 mm	5
P065/10.50	€ 13,80	10,50 mm	133 mm	87 mm	5
P065/10.75	€ 13,80	10,75 mm	142 mm	94 mm	5
P065/11.00	€ 13,80	11 mm	142 mm	94 mm	5
P065/11.25	€ 16,50	11,25 mm	142 mm	94 mm	5
P065/11.50	€ 16,50	11,50 mm	142 mm	94 mm	5
P065/11.75	€ 16,50	11,75 mm	142 mm	94 mm	5
P065/12.00	€ 16,50	12 mm	151 mm	101 mm	5
P065/12.25	€ 20,00	12,25 mm	151 mm	101 mm	5
P065/12.50	€ 20,00	12,50 mm	151 mm	101 mm	5
P065/12.75	€ 20,00	12,75 mm	151 mm	101 mm	5
P065/13.00	€ 20,00	13 mm	151 mm	101 mm	5

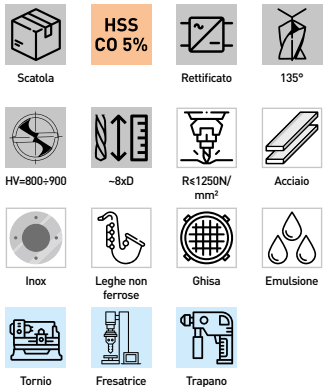

P067

€ 67,20

SERIE PUNTE AL COBALTO

DIN 338/N, autocentrante, destra, con grande resistenza termica



19 Pcs

Misura (progressione 0,5 mm)

1 ÷ 10 mm

P069

€ 132,00

SERIE PUNTE AL COBALTO

DIN 338/N, autocentrante, destra, con grande resistenza termica



25 Pcs

Misura (progressione 0,5 mm)

1 ÷ 13 mm





P064-

PUNTA CILINDRICA RETTIFICATA

DIN 338/N, autocentrante, destra, con grande resistenza termica

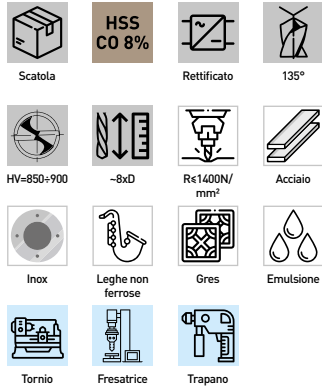
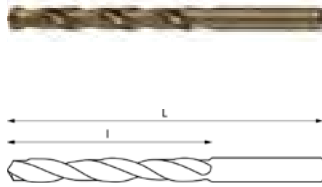

Art.	€	Ø	L	l	Pack
P064/01.00	€ 1,42	01.00 mm	34 mm	12 mm	10
P064/01.25	€ 1,42	01.25 mm	38 mm	16 mm	10
P064/01.50	€ 1,42	01.50 mm	40 mm	18 mm	10
P064/01.75	€ 1,42	01.75 mm	46 mm	22 mm	10
P064/02.00	€ 1,42	02.00 mm	49 mm	24 mm	10
P064/02.25	€ 1,65	02.25 mm	53 mm	27 mm	10
P064/02.50	€ 1,65	02.50 mm	57 mm	30 mm	10
P064/02.75	€ 1,65	02.75 mm	61 mm	33 mm	10
P064/03.00	€ 1,65	03.00 mm	61 mm	33 mm	10
P064/03.25	€ 2,26	03.25 mm	69 mm	39 mm	10
P064/03.50	€ 2,26	03.50 mm	70 mm	39 mm	10
P064/03.75	€ 2,26	03.75 mm	70 mm	39 mm	10
P064/04.00	€ 2,26	04.00 mm	75 mm	43 mm	10
P064/04.25	€ 3,18	04.25 mm	75 mm	43 mm	10
P064/04.50	€ 3,18	04.50 mm	80 mm	47 mm	10
P064/04.75	€ 3,18	04.75 mm	80 mm	47 mm	10
P064/05.00	€ 3,18	05.00 mm	86 mm	52 mm	10
P064/05.25	€ 4,02	05.25 mm	86 mm	52 mm	10
P064/05.50	€ 4,02	05.50 mm	93 mm	57 mm	10
P064/05.75	€ 4,02	05.75 mm	93 mm	57 mm	10
P064/06.00	€ 4,02	06.00 mm	93 mm	57 mm	10
P064/06.25	€ 4,89	06.25 mm	101 mm	63 mm	10
P064/06.50	€ 4,89	06.50 mm	101 mm	63 mm	10
P064/06.75	€ 4,89	06.75 mm	109 mm	69 mm	10
P064/07.00	€ 4,89	07.00 mm	109 mm	69 mm	10
P064/07.25	€ 8,50	07.25 mm	109 mm	69 mm	10
P064/07.50	€ 8,50	07.50 mm	109 mm	69 mm	10
P064/07.75	€ 8,50	07.75 mm	117 mm	75 mm	10
P064/08.00	€ 8,50	08.00 mm	117 mm	75 mm	5
P064/08.25	€ 10,60	08.25 mm	117 mm	75 mm	5
P064/08.50	€ 10,60	08.50 mm	117 mm	75 mm	5
P064/08.75	€ 10,60	08.75 mm	125 mm	81 mm	5
P064/09.00	€ 10,60	09.00 mm	125 mm	81 mm	5
P064/09.25	€ 13,30	09.25 mm	125 mm	81 mm	5
P064/09.50	€ 13,30	09.50 mm	125 mm	81 mm	5
P064/09.75	€ 13,30	09.75 mm	133 mm	87 mm	5
P064/10.00	€ 13,30	10.00 mm	133 mm	87 mm	5
P064/10.25	€ 16,00	10.25 mm	133 mm	87 mm	5
P064/10.50	€ 16,00	10.50 mm	133 mm	87 mm	5
P064/10.75	€ 16,00	10.75 mm	142 mm	94 mm	5
P064/11.00	€ 16,00	11.00 mm	142 mm	94 mm	5
P064/11.25	€ 19,10	11.25 mm	142 mm	94 mm	5
P064/11.50	€ 19,10	11.50 mm	142 mm	94 mm	5
P064/11.75	€ 19,10	11.75 mm	142 mm	94 mm	5
P064/12.00	€ 19,10	12.00 mm	151 mm	101 mm	5
P064/12.25	€ 23,20	12.25 mm	151 mm	101 mm	5
P064/12.50	€ 23,20	12.50 mm	151 mm	101 mm	5
P064/12.75	€ 23,20	12.75 mm	151 mm	101 mm	5
P064/13.00	€ 23,20	13.00 mm	151 mm	101 mm	5

P064/19A

€ 81,30

SERIE PUNTE AL COBALTO

DIN 338/N, autocentrante, destra, con grande resistenza termica.



Misura (progressione 0,5 mm) 1 ÷ 10 mm

P064/25A

€ 173,00

SERIE PUNTE AL COBALTO

DIN 338/N, autocentrante, destra, con grande resistenza termica



Misura (progressione 0,5 mm) 1 ÷ 13 mm



ST2AX

PUNTA ELICOIDALE A CODOLO CONICO

DIN 345/N, destra



Scatola

HSS



118°



HV=700-740



-8xD



Re650N/mm²



Acciaio



Alluminio



Leghe non ferrose



Ghisa



Emulsione



Tornio



Fresatrice



Trapano a colonna

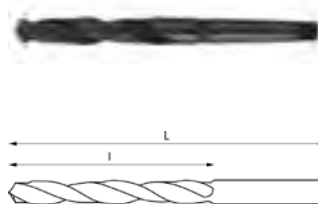

Art.	€	Ø	CM	L	l
ST2A05.75	€ 8,40	5,75 mm	1	138 mm	57 mm
ST2A06	€ 8,40	6,00 mm	1	138 mm	57 mm
ST2A06.25	€ 8,40	6,25 mm	1	144 mm	63 mm
ST2A06.50	€ 8,40	6,50 mm	1	144 mm	63 mm
ST2A06.75	€ 8,40	6,75 mm	1	150 mm	69 mm
ST2A07	€ 8,40	7,00 mm	1	150 mm	69 mm
ST2A07.25	€ 8,40	7,25 mm	1	150 mm	69 mm
ST2A07.50	€ 8,40	7,50 mm	1	150 mm	69 mm
ST2A07.75	€ 8,40	7,75 mm	1	156 mm	75 mm
ST2A08	€ 8,40	8,00 mm	1	156 mm	75 mm
ST2A08.25	€ 8,40	8,25 mm	1	156 mm	75 mm
ST2A08.50	€ 8,40	8,50 mm	1	156 mm	75 mm
ST2A08.75	€ 8,40	8,75 mm	1	156 mm	75 mm
ST2A09	€ 8,40	9,00 mm	1	162 mm	81 mm
ST2A09.25	€ 8,40	9,25 mm	1	162 mm	81 mm
ST2A09.50	€ 8,40	9,50 mm	1	162 mm	81 mm
ST2A09.75	€ 8,40	9,75 mm	1	162 mm	81 mm
ST2A10	€ 8,40	10,00 mm	1	168 mm	81 mm
ST2A10.25	€ 9,70	10,25 mm	1	168 mm	87 mm
ST2A10.50	€ 9,70	10,50 mm	1	168 mm	87 mm
ST2A10.75	€ 9,70	10,75 mm	1	175 mm	87 mm
ST2A11	€ 9,70	11,00 mm	1	175 mm	94 mm
ST2A11.25	€ 9,70	11,25 mm	1	175 mm	94 mm
ST2A11.50	€ 9,70	11,50 mm	1	175 mm	94 mm
ST2A11.75	€ 9,70	11,75 mm	1	175 mm	94 mm
ST2A12	€ 9,70	12,00 mm	1	182 mm	94 mm
ST2A12.25	€ 11,10	12,25 mm	1	182 mm	101 mm
ST2A12.50	€ 11,10	12,50 mm	1	182 mm	101 mm
ST2A12.75	€ 11,10	12,75 mm	1	182 mm	101 mm
ST2A13	€ 11,10	13,00 mm	1	182 mm	101 mm
ST2A13.25	€ 11,10	13,25 mm	1	182 mm	101 mm
ST2A13.50	€ 11,10	13,50 mm	1	189 mm	108 mm
ST2A13.75	€ 11,10	13,75 mm	1	189 mm	108 mm
ST2A14	€ 11,10	14,00 mm	1	189 mm	108 mm
ST2A14.25	€ 11,10	14,25 mm	2	212 mm	114 mm
ST2A14.50	€ 11,10	14,50 mm	2	212 mm	114 mm
ST2A14.75	€ 11,10	14,75 mm	2	212 mm	114 mm
ST2A15	€ 11,10	15,00 mm	2	212 mm	114 mm
ST2A15.25	€ 16,50	15,25 mm	2	218 mm	120 mm
ST2A15.50	€ 16,50	15,50 mm	2	218 mm	120 mm
ST2A15.75	€ 16,50	15,75 mm	2	218 mm	120 mm
ST2A16	€ 16,50	16,00 mm	2	218 mm	120 mm
ST2A16.25	€ 16,50	16,25 mm	2	223 mm	125 mm
ST2A16.50	€ 16,50	16,50 mm	2	223 mm	125 mm
ST2A16.75	€ 16,50	16,75 mm	2	223 mm	125 mm
ST2A17	€ 16,50	17,00 mm	2	223 mm	125 mm
ST2A17.25	€ 16,50	17,25 mm	2	228 mm	130 mm
ST2A17.50	€ 16,50	17,50 mm	2	228 mm	130 mm
ST2A17.75	€ 16,50	17,75 mm	2	228 mm	130 mm
ST2A18	€ 20,20	18,00 mm	2	228 mm	130 mm
ST2A18.25	€ 20,20	18,25 mm	2	233 mm	135 mm
ST2A18.50	€ 20,20	18,50 mm	2	233 mm	135 mm
ST2A18.75	€ 20,20	18,75 mm	2	233 mm	135 mm
ST2A19	€ 20,20	19,00 mm	2	233 mm	135 mm
ST2A19.25	€ 21,40	19,25 mm	2	238 mm	140 mm
ST2A19.50	€ 21,40	19,50 mm	2	238 mm	140 mm
ST2A19.75	€ 21,40	19,75 mm	2	238 mm	140 mm
ST2A20	€ 21,40	20,00 mm	2	238 mm	140 mm
ST2A20.25	€ 21,40	20,25 mm	2	243 mm	145 mm
ST2A20.50	€ 24,80	20,50 mm	2	243 mm	145 mm
ST2A20.75	€ 24,80	20,75 mm	2	243 mm	145 mm
ST2A21	€ 24,80	21,00 mm	2	243 mm	145 mm
ST2A21.25	€ 27,30	21,25 mm	2	248 mm	150 mm
ST2A21.50	€ 27,30	21,50 mm	2	248 mm	150 mm
ST2A21.75	€ 27,30	21,75 mm	2	248 mm	150 mm
ST2A22	€ 27,30	22,00 mm	2	248 mm	150 mm
ST2A22.25	€ 28,70	22,25 mm	2	248 mm	150 mm

Art.	€	Ø	CM	L	l
ST2A22.50	€ 28,70	22,50 mm	2	253 mm	155 mm
ST2A22.75	€ 28,70	22,75 mm	2	253 mm	155 mm
ST2A23	€ 28,70	23,00 mm	2	253 mm	155 mm
ST2A23.25	€ 28,70	23,25 mm	3	276 mm	155 mm
ST2A23.50	€ 31,70	23,50 mm	3	276 mm	155 mm
ST2A23.75	€ 31,70	23,75 mm	3	281 mm	160 mm
ST2A24	€ 31,70	24,00 mm	3	281 mm	160 mm
ST2A24.25	€ 35,10	24,25 mm	3	281 mm	160 mm
ST2A24.50	€ 35,10	24,50 mm	3	281 mm	160 mm
ST2A24.75	€ 35,10	24,75 mm	3	281 mm	160 mm
ST2A25	€ 35,10	25,00 mm	3	281 mm	160 mm
ST2A25.25	€ 37,60	25,25 mm	3	281 mm	160 mm
ST2A25.50	€ 37,60	25,50 mm	3	281 mm	160 mm
ST2A25.75	€ 37,60	25,75 mm	3	281 mm	160 mm
ST2A26	€ 37,60	26,00 mm	3	286 mm	165 mm
ST2A26.25	€ 44,50	26,25 mm	3	286 mm	165 mm
ST2A26.50	€ 44,50	26,50 mm	3	286 mm	165 mm
ST2A26.75	€ 44,50	26,75 mm	3	291 mm	170 mm
ST2A27	€ 44,50	27,00 mm	3	291 mm	170 mm
ST2A27.25	€ 44,50	27,25 mm	3	291 mm	170 mm
ST2A27.50	€ 44,50	27,50 mm	3	291 mm	170 mm
ST2A27.75	€ 44,50	27,75 mm	3	291 mm	170 mm
ST2A28	€ 44,50	28,00 mm	3	291 mm	170 mm
ST2A28.25	€ 50,00	28,25 mm	3	296 mm	175 mm
ST2A28.50	€ 50,00	28,50 mm	3	296 mm	175 mm
ST2A28.75	€ 50,00	28,75 mm	3	296 mm	175 mm
ST2A29	€ 50,00	29,00 mm	3	296 mm	175 mm
ST2A29.25	€ 50,00	29,25 mm	3	296 mm	175 mm
ST2A29.50	€ 50,00	29,50 mm	3	296 mm	175 mm
ST2A29.75	€ 50,00	29,75 mm	3	296 mm	175 mm
ST2A30	€ 50,00	30,00 mm	3	296 mm	175 mm
ST2A30.25	€ 50,90	30,25 mm	3	301 mm	180 mm
ST2A30.50	€ 50,90	30,50 mm	3	301 mm	180 mm
ST2A30.75	€ 50,90	30,75 mm	3	301 mm	180 mm
ST2A31	€ 50,90	31,00 mm	3	301 mm	180 mm
ST2A31.25	€ 53,00	31,25 mm	3	301 mm	180 mm
ST2A31.50	€ 53,00	31,50 mm	3	301 mm	180 mm
ST2A31.75	€ 53,00	31,75 mm	4	306 mm	185 mm
ST2A32	€ 53,00	32,00 mm	4	334 mm	185 mm
ST2A32.50	€ 69,60	32,50 mm	4	334 mm	185 mm
ST2A33	€ 69,60	33,00 mm	4	334 mm	185 mm
ST2A33.50	€ 69,60	33,50 mm	4	334 mm	185 mm
ST2A34	€ 69,60	34,00 mm	4	339 mm	190 mm
ST2A34.50	€ 69,60	34,50 mm	4	339 mm	190 mm
ST2A35	€ 69,60	35,00 mm	4	339 mm	190 mm
ST2A35.50	€ 81,30	35,50 mm	4	339 mm	190 mm
ST2A36	€ 81,30	36,00 mm	4	344 mm	195 mm
ST2A36.50	€ 81,30	36,50 mm	4	344 mm	195 mm
ST2A37	€ 81,30	37,00 mm	4	344 mm	195 mm
ST2A37.50	€ 81,30	37,50 mm	4	344 mm	195 mm
ST2A38	€ 81,30	38,00 mm	4	349 mm	200 mm
ST2A38.50	€ 93,60	38,50 mm	4	349 mm	200 mm
ST2A39	€ 93,60	39,00 mm	4	349 mm	200 mm
ST2A39.50	€ 93,60	39,50 mm	4	349 mm	200 mm
ST2A40	€ 93,60	40,00 mm	4	349 mm	200 mm
ST2A40.50	€ 105,00	40,50 mm	4	354 mm	205 mm
ST2A41	€ 105,00	41,00 mm	4	354 mm	205 mm
ST2A41.50	€ 105,00	41,50 mm	4	354 mm	205 mm
ST2A42	€ 105,00	42,00 mm	4	354 mm	205 mm
ST2A42.50	€ 116,00	42,50 mm	4	354 mm	205 mm
ST2A43	€ 116,00	43,00 mm	4	359 mm	210 mm
ST2A43.50	€ 116,00	43,50 mm	4	359 mm	210 mm
ST2A44	€ 116,00	44,00 mm	4	359 mm	210 mm
ST2A44.50	€ 116,00	44,50 mm	4	359 mm	210 mm
ST2A45	€ 129,00	45,00 mm	4	359 mm	210 mm
ST2A45.50	€ 129,00	45,50 mm	4	364 mm	215 mm
ST2A46	€ 129,00	46,00 mm	4	364 mm	215 mm

Art.	€	Ø	CM	L	l
ST2A46.50	€ 150,00	46,50 mm	4	364 mm	215 mm
ST2A47	€ 150,00	47,00 mm	4	364 mm	215 mm
ST2A47.50	€ 150,00	47,50 mm	4	364 mm	215 mm
ST2A48	€ 150,00	48,00 mm	4	369 mm	220 mm
ST2A48.50	€ 166,00	48,50 mm	4	369 mm	220 mm
ST2A49	€ 166,00	49,00 mm	4	369 mm	220 mm
ST2A49.50	€ 166,00	49,50 mm	4	369 mm	220 mm
ST2A50	€ 169,00	50,00 mm	4	369 mm	220 mm
ST2A50.50	€ 173,00	50,50 mm	4	374 mm	225 mm
ST2A51	€ 179,00	51,00 mm	5	412 mm	225 mm
ST2A51.50	€ 185,00	51,50 mm	5	412 mm	225 mm
ST2A52	€ 195,00	52,00 mm	5	412 mm	225 mm
ST2A53	€ 195,00	53,00 mm	5	412 mm	225 mm
ST2A54	€ 195,00	54,00 mm	5	417 mm	230 mm
ST2A55	€ 195,00	55,00 mm	5	417 mm	230 mm
ST2A56	€ 227,00	56,00 mm	5	417 mm	230 mm
ST2A57	€ 227,00	57,00 mm	5	422 mm	235 mm
ST2A58	€ 227,00	58,00 mm	5	422 mm	235 mm
ST2A59	€ 227,00	59,00 mm	5	422 mm	235 mm
ST2A60	€ 227,00	60,00 mm	5	422 mm	235 mm
ST2A61	€ 271,00	61,00 mm	5	427 mm	240 mm
ST2A62	€ 293,00	62,00 mm	5	427 mm	240 mm
ST2A63	€ 336,00	63,00 mm	5	427 mm	240 mm
ST2A65	€ 336,00	65,00 mm	5	432 mm	245 mm
ST2A66	€ 336,00	66,00 mm	5	432 mm	245 mm
ST2A67	€ 340,00	67,00 mm	5	432 mm	245 mm
ST2A68	€ 349,00	68,00 mm	5	437 mm	250 mm
ST2A69	€ 353,00	69,00 mm	5	437 mm	250 mm
ST2A70	€ 353,00	70,00 mm	5	437 mm	250 mm
ST2A71	€ 353,00	71,00 mm	5	437 mm	250 mm
ST2A72	€ 353,00	72,00 mm	5	442 mm	255 mm
ST2A73	€ 400,00	73,00 mm	5	442 mm	255 mm
ST2A74	€ 400,00	74,00 mm	5	442 mm	255 mm
ST2A75	€ 419,00	75,00 mm	5	442 mm	



P081-

PRO NEW

PUNTA DA CENTRO PER MACCHINE CN

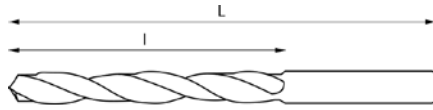

Art.	€	Diametro	l	L
P081/03	€ 6,40	3 mm	12 mm	46 mm
P081/04	€ 8,30	4 mm	12 mm	55 mm
P081/05	€ 10,20	5 mm	15 mm	60 mm
P081/06	€ 12,30	6 mm	20 mm	66 mm
P081/08	€ 17,40	8 mm	25 mm	79 mm
P081/10	€ 22,30	10 mm	25 mm	89 mm
P081/12	€ 31,20	12 mm	30 mm	102 mm
P081/16	€ 50,50	16 mm	35 mm	115 mm
P081/20	€ 70,40	20 mm	40 mm	131 mm

P056-

PUNTA DA CENTRO

DIN 333, rettificata, con scanalature vaporizzate. Angolo conicità 60°



Art.	€	Ø	Gambo	Lunghezza
P056/1	€ 2,45	1 mm	Ø 3 mm	30,5 mm
P056/1.6	€ 2,45	1,6 mm	Ø 4 mm	35,5 mm
P056/2	€ 3,67	2 mm	Ø 5 mm	40 mm
P056/2.5	€ 3,87	2,5 mm	Ø 6,3 mm	45 mm
P056/3.15	€ 4,27	3,15 mm	Ø 8 mm	50 mm
P056/4	€ 7,60	4 mm	Ø 10 mm	56 mm
P056/5	€ 10,20	5 mm	Ø 12,5 mm	63 mm

P056/10S

€ 34,70

SERIE PUNTE DA CENTRO

DIN 333, rettificata, con scanalature vaporizzate. Angolo conicità 60°

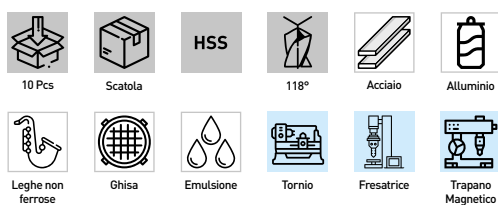

Misure	0.75 - 1.00 - 1.5 - 1.6 - 2.0 - 2.5 - 3.0 - 3.15 - 4.0 - 5.0 mm
Tipo	A
Tolleranza	K12



SEGHE A CAROTARE

Utensili progettati per forare e lavorare materiali metallici. Sono punte cilindriche con una sezione circolare dentata. Si montano al mandrino di appositi utensili come macchine foratrici, trapani a base magnetica e trapani a colonna. A differenza delle frese a tazza, che presentano una corona che mantiene all'interno il materiale da asportare, queste frese lavorano il materiale per asportazione del truciolo attraverso i taglienti laterali dell'utensile.



N° DI GIRI TEORICI PER SEGHE A CAROTARE IN FUNZIONE AL MATERIALE DA LAVORARE

Materiale da lavorare	Tipo Sega	Ø Sega							Refrigerante
		12 - 15	16 - 20	21 - 25	26 - 30	31 - 35	36 - 49	50 - 60	
		n. di giri (rpm)							
Acciaio da costruzione basso legato R< 700÷900N/mm ²	HSS	700	530	420	340	290	240	170	Emulsione
	HSS-Co5%	875	663	525	425	363	300	213	Emulsione
Acciaio legato R<1100÷1300N/mm ²	HSS	470	350	270	230	190	160	120	Emulsione
	HSS-Co5%	588	438	338	288	238	200	150	Emulsione
Acciaio Inox	HSS	470	350	270	230	190	160	120	Emulsione
	HSS-Co5%	588	438	338	288	238	200	150	Emulsione
Ghisa	HSS	240	180	140	120	100	80	60	No refriger.
Leghe Leggere	HSS	700	530	420	340	290	240	170	No refriger.
Plastica	HSS	830	620	480	400	340	280	200	No refriger.





F011-

SEGA A CAROTARE CON ATTACCO WELDON

Permette un taglio molto veloce, non necessita di preforo e non crea nessuna formazione di bava grazie al minor sforzo del tagliente durante la lavorazione

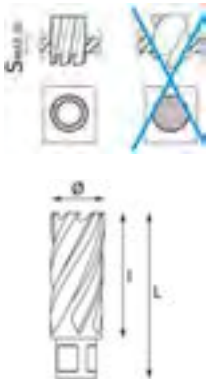

Art.	€	Capacità di taglio	Ø	Lunghezza totale
F011/12	€ 23,50	30 mm	12 mm	62 mm
F011/13	€ 24,50	30 mm	13 mm	62 mm
F011/14	€ 28,40	30 mm	14 mm	62 mm
F011/15	€ 29,30	30 mm	15 mm	62 mm
F011/16	€ 31,30	30 mm	16 mm	62 mm
F011/17	€ 32,30	30 mm	17 mm	62 mm
F011/18	€ 34,20	30 mm	18 mm	62 mm
F011/19	€ 35,10	30 mm	19 mm	62 mm
F011/20	€ 36,20	30 mm	20 mm	62 mm
F011/21	€ 36,70	30 mm	21 mm	62 mm
F011/22	€ 38,10	30 mm	22 mm	62 mm
F011/23	€ 39,10	30 mm	23 mm	62 mm
F011/24	€ 41,60	30 mm	24 mm	62 mm
F011/25	€ 43,10	30 mm	25 mm	62 mm
F011/26	€ 48,90	30 mm	26 mm	62 mm
F011/27	€ 50,30	30 mm	27 mm	62 mm
F011/28	€ 51,80	30 mm	28 mm	62 mm
F011/29	€ 53,30	30 mm	29 mm	62 mm
F011/30	€ 54,70	30 mm	30 mm	62 mm
F011/31	€ 57,10	30 mm	31 mm	62 mm
F011/32	€ 58,70	30 mm	32 mm	62 mm
F011/33	€ 60,40	30 mm	33 mm	62 mm
F011/34	€ 62,10	30 mm	34 mm	62 mm
F011/35	€ 63,50	30 mm	35 mm	62 mm
F011/36	€ 65,30	30 mm	36 mm	62 mm
F011/37	€ 67,00	30 mm	37 mm	62 mm
F011/38	€ 69,20	30 mm	38 mm	62 mm
F011/39	€ 71,20	30 mm	39 mm	62 mm
F011/40	€ 72,40	30 mm	40 mm	62 mm
F011/41	€ 83,60	30 mm	41 mm	62 mm
F011/42	€ 85,50	30 mm	42 mm	62 mm
F011/43	€ 87,00	30 mm	43 mm	62 mm
F011/44	€ 88,90	30 mm	44 mm	62 mm
F011/45	€ 104,00	30 mm	45 mm	62 mm
F011/46	€ 106,00	30 mm	46 mm	62 mm
F011/47	€ 108,00	30 mm	47 mm	62 mm
F011/48	€ 111,00	30 mm	48 mm	62 mm
F011/49	€ 113,00	30 mm	49 mm	62 mm
F011/50	€ 115,00	30 mm	50 mm	62 mm
F011/51	€ 125,00	30 mm	51 mm	62 mm
F011/52	€ 127,00	30 mm	52 mm	62 mm
F011/53	€ 129,00	30 mm	53 mm	62 mm
F011/54	€ 132,00	30 mm	54 mm	62 mm
F011/55	€ 137,00	30 mm	55 mm	62 mm
F011/60	€ 160,00	30 mm	60 mm	62 mm

F011/6

€ 185,00

SERIE DI TAZZE A CAROTARE CON ATTACCO WELDON

Permette un taglio molto veloce, non necessita di preforo e non crea nessuna formazione di bava grazie al minor sforzo del tagliente durante la lavorazione.

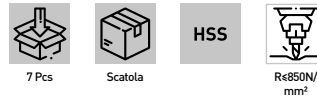

Misure	12 x 62 - 14 x 62 - 16 x 62 - 18 x 62 - 20 x 62 - 22 x 62 mm
Capacità di taglio	30 mm
Attacco	Weldon 19,05 mm

F011-XP

PUNTE CON ATTACCO WELDON

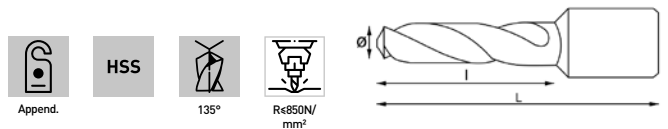

Art.	€	Ø	L	L
F011/006P	€ 28,70	6 mm	30 mm	62 mm
F011/007P	€ 28,70	7 mm	30 mm	62 mm
F011/008P	€ 28,70	8 mm	30 mm	62 mm
F011/009P	€ 31,70	9 mm	30 mm	62 mm
F011/010P	€ 31,70	10 mm	30 mm	62 mm
F011/011P	€ 34,70	11 mm	30 mm	62 mm

F002-

PRO

SEGA A CAROTARE CON ATTACCO WELDON

Permette un taglio molto veloce, non necessita di preforo e non crea nessuna formazione di bava grazie al minor sforzo del tagliente durante la lavorazione

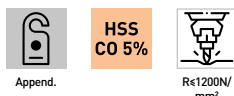
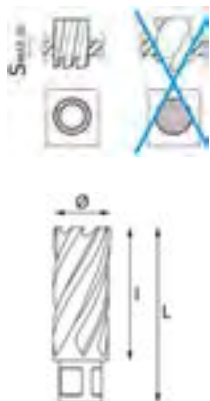

Art.	€	Ø	Capacità di taglio	Lunghezza totale
F002/12	€ 38,90	12 mm	30 mm	62 mm
F002/13	€ 41,10	13 mm	30 mm	62 mm
F002/14	€ 44,90	14 mm	30 mm	62 mm
F002/15	€ 48,90	15 mm	30 mm	62 mm
F002/16	€ 50,80	16 mm	30 mm	62 mm
F002/17	€ 50,80	17 mm	30 mm	62 mm
F002/18	€ 50,80	18 mm	30 mm	62 mm
F002/19	€ 51,80	19 mm	30 mm	62 mm
F002/20	€ 53,80	20 mm	30 mm	62 mm
F002/21	€ 55,70	21 mm	30 mm	62 mm
F002/22	€ 57,70	22 mm	30 mm	62 mm
F002/23	€ 59,10	23 mm	30 mm	62 mm
F002/24	€ 62,60	24 mm	30 mm	62 mm
F002/25	€ 64,50	25 mm	30 mm	62 mm
F002/26	€ 74,20	26 mm	30 mm	62 mm
F002/27	€ 77,30	27 mm	30 mm	62 mm
F002/28	€ 79,20	28 mm	30 mm	62 mm
F002/29	€ 80,10	29 mm	30 mm	62 mm
F002/30	€ 83,10	30 mm	30 mm	62 mm
F002/31	€ 87,00	31 mm	30 mm	62 mm
F002/32	€ 90,00	32 mm	30 mm	62 mm
F002/33	€ 96,80	33 mm	30 mm	62 mm
F002/34	€ 102,00	34 mm	30 mm	62 mm
F002/35	€ 105,00	35 mm	30 mm	62 mm
F002/36	€ 109,00	36 mm	30 mm	62 mm
F002/37	€ 114,00	37 mm	30 mm	62 mm
F002/38	€ 118,00	38 mm	30 mm	62 mm
F002/39	€ 123,00	39 mm	30 mm	62 mm
F002/40	€ 127,00	40 mm	30 mm	62 mm
F002/41	€ 132,00	41 mm	30 mm	62 mm
F002/42	€ 138,00	42 mm	30 mm	62 mm
F002/43	€ 141,00	43 mm	30 mm	62 mm
F002/44	€ 148,00	44 mm	30 mm	62 mm
F002/45	€ 158,00	45 mm	30 mm	62 mm
F002/46	€ 160,00	46 mm	30 mm	62 mm
F002/47	€ 164,00	47 mm	30 mm	62 mm
F002/48	€ 167,00	48 mm	30 mm	62 mm
F002/49	€ 172,00	49 mm	30 mm	62 mm
F002/50	€ 176,00	50 mm	30 mm	62 mm
F002/55	€ 205,00	55 mm	30 mm	62 mm
F002/60	€ 317,00	60 mm	30 mm	62 mm

F002/6

PRO

€ 283,00

SERIE SEGHE A CAROTARE CON ATTACCO WELDON

Permette un taglio molto veloce, non necessita di preforo e non crea nessuna formazione di bava grazie al minor sforzo del tagliente durante la lavorazione.



Misure 12 x 62 - 14 x 62 - 16 x 62 - 18 x 62 - 20 x 62 - 22 x 62 mm
Attacco Weldon 19,05 mm

F002-XP

PRO

PUNTE CON ATTACCO WELDON

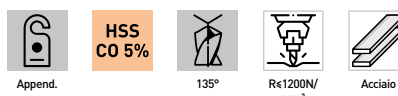
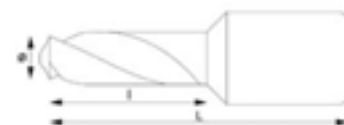

Art.	€	Ø	l	L
F002/006P	€ 26,70	6 mm	30 mm	62.50 mm
F002/007P	€ 26,70	7 mm	30 mm	62.50 mm
F002/008P	€ 26,70	8 mm	30 mm	62.50 mm
F002/009P	€ 26,70	9 mm	30 mm	62.50 mm
F002/010P	€ 26,70	10 mm	30 mm	62.50 mm
F002/011P	€ 26,70	11 mm	30 mm	62.50 mm



F002-XL

PRO

SEGA A CAROTARE LUNGA CON ATTACCO WELDON

Permette un taglio molto veloce, non necessita di preforo e non crea nessuna formazione di bava grazie al minor sforzo del tagliente durante la lavorazione

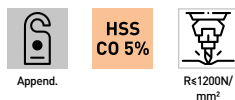

Art.	€	ø	Capacità di taglio	Lunghezza totale
F002/12L	€ 54,70	12 mm	50 mm	85 mm
F002/13L	€ 55,70	13 mm	50 mm	85 mm
F002/14L	€ 65,50	14 mm	50 mm	85 mm
F002/15L	€ 66,50	15 mm	50 mm	85 mm
F002/16L	€ 71,40	16 mm	50 mm	85 mm
F002/17L	€ 74,20	17 mm	50 mm	85 mm
F002/18L	€ 77,30	18 mm	50 mm	85 mm
F002/19L	€ 79,20	19 mm	50 mm	85 mm
F002/20L	€ 81,10	20 mm	50 mm	85 mm
F002/21L	€ 83,10	21 mm	50 mm	85 mm
F002/22L	€ 85,00	22 mm	50 mm	85 mm
F002/23L	€ 87,00	23 mm	50 mm	85 mm
F002/24L	€ 91,90	24 mm	50 mm	85 mm
F002/25L	€ 93,80	25 mm	50 mm	85 mm
F002/26L	€ 109,00	26 mm	50 mm	85 mm
F002/27L	€ 111,00	27 mm	50 mm	85 mm
F002/28L	€ 114,00	28 mm	50 mm	85 mm
F002/29L	€ 116,00	29 mm	50 mm	85 mm
F002/30L	€ 118,00	30 mm	50 mm	85 mm
F002/31L	€ 125,00	31 mm	50 mm	85 mm
F002/32L	€ 128,00	32 mm	50 mm	85 mm
F002/33L	€ 129,00	33 mm	50 mm	85 mm
F002/34L	€ 133,00	34 mm	50 mm	85 mm
F002/35L	€ 135,00	35 mm	50 mm	85 mm
F002/36L	€ 140,00	36 mm	50 mm	85 mm
F002/37L	€ 141,00	37 mm	50 mm	85 mm
F002/38L	€ 146,00	38 mm	50 mm	85 mm
F002/39L	€ 150,00	39 mm	50 mm	85 mm
F002/40L	€ 151,00	40 mm	50 mm	85 mm
F002/41L	€ 176,00	41 mm	50 mm	85 mm
F002/42L	€ 179,00	42 mm	50 mm	85 mm
F002/43L	€ 183,00	43 mm	50 mm	85 mm
F002/44L	€ 186,00	44 mm	50 mm	85 mm
F002/45L	€ 223,00	45 mm	50 mm	85 mm
F002/46L	€ 226,00	46 mm	50 mm	85 mm
F002/47L	€ 229,00	47 mm	50 mm	85 mm
F002/48L	€ 233,00	48 mm	50 mm	85 mm
F002/49L	€ 237,00	49 mm	50 mm	85 mm
F002/50L	€ 241,00	50 mm	50 mm	85 mm
F002/55L	€ 284,00	55 mm	50 mm	85 mm
F002/60L	€ 328,00	60 mm	50 mm	85 mm

F002-XPL

PRO

PUNTE LUNGHE CON ATTACCO WELDON

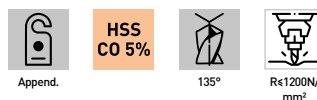
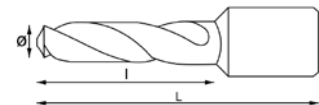

Art.	€	ø	L	L
F002/006PL	€ 34,70	6 mm	55 mm	86.50 mm
F002/007PL	€ 34,70	7 mm	55 mm	86.50 mm
F002/008PL	€ 34,70	8 mm	55 mm	86.50 mm
F002/009PL	€ 34,70	9 mm	55 mm	86.50 mm
F002/010PL	€ 34,70	10 mm	55 mm	86.50 mm
F002/011PL	€ 34,70	11 mm	55 mm	86.50 mm

F002/P

PRO € 7,80

ESPULSORE

Per seghe a carotare

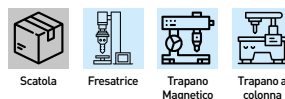

Dimensioni 6,35 x 77 mm

F002/PL

PRO € 9,70

ESPULSORE

Per seghe a carotare lunghe

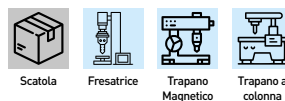

Dimensioni 6,35 x 102 mm

SEGHE A TAZZA CON INSERTI IN METALLO DURO



La geometria variabile dei denti in metallo duro consente il taglio di tubi, profilati e lamiere in acciaio inox, acciai alto-legati. Spessore massimo di taglio: 5 mm

N° DI GIRI TEORICI PER SEGHE A TAZZA CON INSERTI IN METALLO DURO IN FUNZIONE AL MATERIALE DA LAVORARE

Materiale da lavorare	Ø Sega							Refrigerante
	15 - 20	21 - 25	26 - 30	31 - 40	41 - 50	51 - 70	71 - 100	
	n. di giri (rpm)							
Acciaio legato R<1100÷1300N/mm ²	530	420	340	270	210	160	100	Emulsione
Acciaio Inox	530	420	340	270	210	160	100	Emulsione
Alluminio	880	690	570	450	350	270	190	Emulsione





F019-

SEGA A TAZZA CON INSERTI IN METALLO DURO

Con scarico truciolo laterale e punta pilota



Art.	€	ø	h	d	L	Profondità di taglio	Filetto
F019/015	€ 12,50	15 mm	28 mm	10 mm	50 mm	5 mm	-
F019/016	€ 13,40	16 mm	28 mm	10 mm	50 mm	5 mm	-
F019/017	€ 14,30	17 mm	28 mm	10 mm	50 mm	5 mm	-
F019/018	€ 15,20	18 mm	28 mm	10 mm	50 mm	5 mm	-
F019/019	€ 16,00	19 mm	28 mm	10 mm	50 mm	5 mm	-
F019/020	€ 17,00	20 mm	28 mm	10 mm	50 mm	5 mm	-
F019/021	€ 17,80	21 mm	28 mm	10 mm	50 mm	5 mm	-
F019/022	€ 18,80	22 mm	28 mm	10 mm	50 mm	5 mm	M12 x 1,25
F019/023	€ 19,60	23 mm	28 mm	10 mm	50 mm	5 mm	M12 x 1,25
F019/024	€ 20,50	24 mm	28 mm	10 mm	50 mm	5 mm	M12 x 1,25
F019/025	€ 21,40	25 mm	28 mm	10 mm	50 mm	5 mm	M12 x 1,25
F019/026	€ 22,30	26 mm	28 mm	10 mm	50 mm	5 mm	M12 x 1,25
F019/027	€ 23,20	27 mm	28 mm	10 mm	50 mm	5 mm	M12 x 1,25
F019/028	€ 24,10	28 mm	28 mm	10 mm	50 mm	5 mm	M12 x 1,25
F019/029	€ 24,90	29 mm	28 mm	10 mm	50 mm	5 mm	M12 x 1,25
F019/030	€ 25,90	30 mm	28 mm	10 mm	50 mm	5 mm	M12 x 1,25
F019/031	€ 26,70	31 mm	28 mm	10 mm	50 mm	5 mm	M12 x 1,25
F019/032	€ 27,70	32 mm	28 mm	10 mm	50 mm	5 mm	M12 x 1,25
F019/033	€ 28,50	33 mm	28 mm	10 mm	50 mm	5 mm	M12 x 1,25
F019/034	€ 29,50	34 mm	28 mm	10 mm	50 mm	5 mm	M12 x 1,25
F019/035	€ 30,30	35 mm	28 mm	10 mm	50 mm	5 mm	M14 x 1,5
F019/036	€ 31,20	36 mm	28 mm	10 mm	50 mm	5 mm	M14 x 1,5
F019/037	€ 32,10	37 mm	28 mm	10 mm	50 mm	5 mm	M14 x 1,5
F019/038	€ 33,00	38 mm	28 mm	10 mm	50 mm	5 mm	M14 x 1,5
F019/039	€ 33,80	39 mm	28 mm	10 mm	50 mm	5 mm	M14 x 1,5
F019/040	€ 34,80	40 mm	28 mm	10 mm	50 mm	5 mm	M14 x 1,5
F019/041	€ 35,10	41 mm	28 mm	10 mm	50 mm	5 mm	M14 x 1,5
F019/042	€ 36,10	42 mm	28 mm	10 mm	50 mm	5 mm	M14 x 1,5
F019/043	€ 36,90	43 mm	28 mm	10 mm	50 mm	5 mm	M14 x 1,5
F019/044	€ 37,40	44 mm	28 mm	10 mm	50 mm	5 mm	M14 x 1,5
F019/045	€ 38,40	45 mm	28 mm	10 mm	50 mm	5 mm	M14 x 1,5
F019/046	€ 39,20	46 mm	28 mm	10 mm	50 mm	5 mm	M14 x 1,5
F019/047	€ 40,10	47 mm	28 mm	10 mm	50 mm	5 mm	M14 x 1,5
F019/048	€ 41,00	48 mm	28 mm	10 mm	50 mm	5 mm	M14 x 1,5
F019/049	€ 41,90	49 mm	28 mm	10 mm	50 mm	5 mm	M14 x 1,5
F019/050	€ 42,70	50 mm	28 mm	10 mm	50 mm	5 mm	M14 x 1,5
F019/051	€ 43,70	51 mm	28 mm	12 mm	50 mm	5 mm	M16 x 1,5
F019/052	€ 44,50	52 mm	28 mm	12 mm	50 mm	5 mm	M16 x 1,5
F019/053	€ 45,50	53 mm	28 mm	12 mm	50 mm	5 mm	M16 x 1,5
F019/054	€ 46,30	54 mm	28 mm	12 mm	50 mm	5 mm	M16 x 1,5
F019/055	€ 47,30	55 mm	28 mm	12 mm	50 mm	5 mm	M16 x 1,5
F019/056	€ 48,10	56 mm	28 mm	12 mm	50 mm	5 mm	M16 x 1,5
F019/057	€ 49,00	57 mm	28 mm	12 mm	50 mm	5 mm	M16 x 1,5
F019/058	€ 49,90	58 mm	28 mm	12 mm	50 mm	5 mm	M16 x 1,5
F019/059	€ 50,80	59 mm	28 mm	12 mm	50 mm	5 mm	M16 x 1,5
F019/060	€ 51,60	60 mm	28 mm	12 mm	50 mm	5 mm	M16 x 1,5
F019/065	€ 59,70	65 mm	28 mm	12 mm	50 mm	5 mm	M16 x 1,5
F019/070	€ 63,30	70 mm	28 mm	12 mm	50 mm	5 mm	M16 x 1,5
F019/075	€ 67,70	75 mm	28 mm	12 mm	50 mm	5 mm	M16 x 1,5
F019/080	€ 72,20	80 mm	28 mm	12 mm	50 mm	5 mm	M16 x 1,5
F019/085	€ 76,60	85 mm	28 mm	12 mm	50 mm	5 mm	M16 x 1,5
F019/090	€ 81,90	90 mm	28 mm	12 mm	50 mm	5 mm	M16 x 1,5
F019/095	€ 86,40	95 mm	28 mm	12 mm	50 mm	5 mm	M16 x 1,5
F019/100	€ 90,80	100 mm	28 mm	12 mm	50 mm	5 mm	M16 x 1,5

F019/006

€ 99,60

SET SEGHE A TAZZA CON INSERTI IN METALLO DURO

Con scarico truciolo laterale e punta pilota.



Misure 16 mm, 18 mm, 20 mm, 22 mm, 25 mm, 30 mm
Profondità di taglio 5 mm

F019/008

€ 141,00

SET SEGHE A TAZZA CON INSERTI IN METALLO DURO

Con scarico truciolo laterale e punta pilota.



Misure 16 mm, 18 mm, 20 mm, 22 mm, 25 mm, 30 mm, 32 mm, 35 mm
Profondità di taglio 5 mm

F019/005

€ 1,88

PUNTA PILOTA

Per articolo F019-

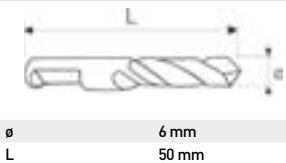

F019/007

€ 0,23

MOLLA

Per articolo F019-



SEGHE A TAZZA IN HSS

Dotata di taglio laterale rompitruciolo. Precisione di foratura di lamiere in acciaio, leghe leggere e materiali metallici in genere. Profondità di foratura sino a 5 mm



N° DI GIRI TEORICI PER SEGHE A TAZZE IN FUNZIONE AL MATERIALE DA LAVORARE

Materiale da lavorare	Ø Sega												Refrigerante
	12-17	18-24	25-32	33-38	39-44	45-51	52-57	58-64	65-70	71-80	81-90	91-100	
	n. di giri (rpm)												
Acciaio da costruzione basso legato R<700÷900N/mm2	550	380	300	240	200	170	150	130	120	110	100	90	Emulsione
Acciaio legato R<1100÷1300N/mm2	230	160	130	100	80	70	60	60	50	50	40	40	Emulsione
Acciaio Inox	230	160	130	100	80	70	60	60	50	50	40	40	Emulsione
Ghisa	280	190	150	120	100	90	80	70	60	60	50	40	No refriger.
Leghe Leggere	870	590	470	370	310	270	240	210	190	170	150	140	Emulsione
Alluminio	870	590	470	370	310	270	240	210	190	170	150	140	Emulsione
Plastica	660	450	350	280	240	210	180	160	150	130	120	100	Acqua No refriger.





F015-

SEGHE A TAZZA

Con scarico truciolo laterale e punta pilota

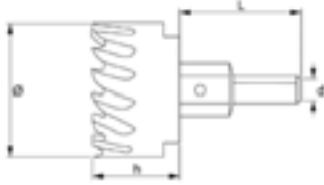

Art.	€	Ø	h	d	L	Filetto
F015/012	€ 10,30	12 mm	23 mm	8 mm	56 mm	M10 x 1,25
F015/013	€ 10,30	13 mm	23 mm	8 mm	56 mm	M10 x 1,25
F015/014	€ 10,80	14 mm	23 mm	8 mm	56 mm	M10 x 1,25
F015/015	€ 10,80	15 mm	23 mm	10 mm	56 mm	M12 x 1,25
F015/016	€ 10,80	16 mm	23 mm	10 mm	56 mm	M12 x 1,25
F015/017	€ 10,80	17 mm	23 mm	10 mm	56 mm	M12 x 1,25
F015/018	€ 10,80	18 mm	23 mm	10 mm	56 mm	M12 x 1,25
F015/019	€ 11,30	19 mm	23 mm	10 mm	56 mm	M12 x 1,25
F015/020	€ 11,80	20 mm	23 mm	10 mm	56 mm	M12 x 1,25
F015/021	€ 12,20	21 mm	23 mm	10 mm	56 mm	M12 x 1,25
F015/022	€ 12,70	22 mm	23 mm	10 mm	56 mm	M12 x 1,25
F015/023	€ 13,80	23 mm	23 mm	10 mm	56 mm	M12 x 1,25
F015/024	€ 14,10	24 mm	23 mm	10 mm	56 mm	M12 x 1,25
F015/025	€ 14,60	25 mm	23 mm	10 mm	56 mm	M12 x 1,25
F015/026	€ 15,60	26 mm	23 mm	10 mm	56 mm	M12 x 1,25
F015/027	€ 16,00	27 mm	23 mm	10 mm	56 mm	M12 x 1,25
F015/028	€ 16,50	28 mm	23 mm	10 mm	56 mm	M12 x 1,25
F015/029	€ 17,00	29 mm	23 mm	10 mm	56 mm	M12 x 1,25
F015/030	€ 17,30	30 mm	23 mm	10 mm	56 mm	M12 x 1,25
F015/031	€ 17,80	31 mm	23 mm	10 mm	56 mm	M12 x 1,25
F015/032	€ 18,80	32 mm	23 mm	10 mm	56 mm	M12 x 1,25
F015/033	€ 18,80	33 mm	23 mm	10 mm	56 mm	M12 x 1,25
F015/034	€ 19,70	34 mm	23 mm	10 mm	56 mm	M12 x 1,25
F015/035	€ 20,70	35 mm	23 mm	10 mm	56 mm	M14 x 1,5
F015/036	€ 21,60	36 mm	23 mm	10 mm	56 mm	M14 x 1,5
F015/037	€ 21,60	37 mm	23 mm	10 mm	56 mm	M14 x 1,5
F015/038	€ 22,10	38 mm	23 mm	10 mm	56 mm	M14 x 1,5
F015/039	€ 24,00	39 mm	23 mm	10 mm	56 mm	M14 x 1,5
F015/040	€ 24,00	40 mm	23 mm	10 mm	56 mm	M14 x 1,5
F015/041	€ 24,50	41 mm	23 mm	10 mm	56 mm	M14 x 1,5
F015/042	€ 24,50	42 mm	23 mm	10 mm	56 mm	M14 x 1,5
F015/043	€ 25,40	43 mm	23 mm	10 mm	56 mm	M14 x 1,5
F015/044	€ 25,90	44 mm	23 mm	10 mm	56 mm	M14 x 1,5
F015/045	€ 27,30	45 mm	23 mm	10 mm	56 mm	M14 x 1,5
F015/046	€ 27,30	46 mm	23 mm	10 mm	56 mm	M14 x 1,5
F015/047	€ 27,80	47 mm	23 mm	10 mm	56 mm	M14 x 1,5
F015/048	€ 29,60	48 mm	23 mm	10 mm	56 mm	M14 x 1,5
F015/049	€ 30,00	49 mm	23 mm	10 mm	56 mm	M14 x 1,5
F015/050	€ 30,00	50 mm	23 mm	10 mm	56 mm	M14 x 1,5
F015/051	€ 36,70	51 mm	23 mm	12 mm	56 mm	M16 x 1,5
F015/052	€ 36,70	52 mm	23 mm	12 mm	56 mm	M16 x 1,5
F015/053	€ 37,60	53 mm	23 mm	12 mm	56 mm	M16 x 1,5
F015/054	€ 39,50	54 mm	23 mm	12 mm	56 mm	M16 x 1,5
F015/055	€ 39,50	55 mm	23 mm	12 mm	56 mm	M16 x 1,5
F015/056	€ 40,40	56 mm	23 mm	12 mm	56 mm	M16 x 1,5
F015/057	€ 40,40	57 mm	23 mm	12 mm	56 mm	M16 x 1,5
F015/058	€ 42,30	58 mm	23 mm	12 mm	56 mm	M16 x 1,5
F015/059	€ 44,20	59 mm	23 mm	12 mm	56 mm	M16 x 1,5
F015/060	€ 44,20	60 mm	23 mm	12 mm	56 mm	M16 x 1,5
F015/065	€ 56,40	65 mm	23 mm	12 mm	56 mm	M16 x 1,5
F015/070	€ 60,20	70 mm	23 mm	12 mm	56 mm	M16 x 1,5
F015/075	€ 64,80	75 mm	23 mm	12 mm	56 mm	M16 x 1,5
F015/080	€ 71,50	80 mm	23 mm	12 mm	56 mm	M16 x 1,5
F015/085	€ 81,80	85 mm	23 mm	12 mm	56 mm	M16 x 1,5
F015/090	€ 90,20	90 mm	23 mm	12 mm	56 mm	M16 x 1,5
F015/095	€ 97,70	95 mm	23 mm	12 mm	56 mm	M16 x 1,5
F015/100	€ 103,00	100 mm	23 mm	12 mm	56 mm	M16 x 1,5

F015/006S

€ 99,60

SET SEGHE A TAZZA

Con scarico truciolo laterale e punta pilota.

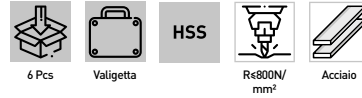

Misure 16 mm, 18 mm, 20 mm, 22 mm, 25 mm, 30 mm

F015/008S

€ 141,00

SET SEGHE A TAZZA

Con scarico truciolo laterale e punta pilota.



Misure 16 mm, 18 mm, 20 mm, 22 mm, 25 mm, 30 mm, 32 mm, 35 mm

F015-A

ALBERO PER SEGHE A TAZZA

Per articolo F015-

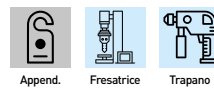
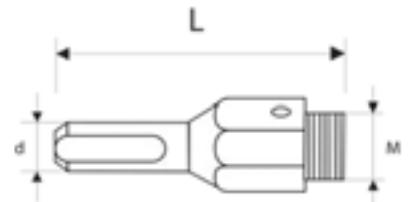

Art.	€	Ø	d	L	Filetto
F015/001	€ 3,29	12 - 14 mm	8 mm	56 mm	M10 x 1,25
F015/002	€ 3,29	15-34 mm	10 mm	56 mm	M12 x 1,25
F015/003	€ 4,71	35-50 mm	10 mm	56 mm	M14 x 1,5
F015/004	€ 4,71	51-100 mm	12 mm	60 mm	M16 x 1,5

F015/005

€ 1,88

PUNTA PILOTA

Per articolo F015-

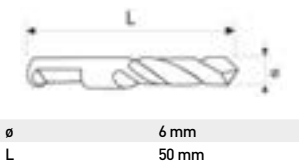

F015/007

€ 0,23

MOLLA

Per articolo F015-

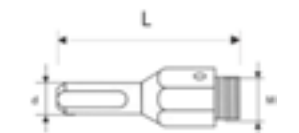

SEGA A TAZZA BIMETALLICA

Dotata di dentatura variabile per il taglio di materiale a spessore sottile quale acciaio, ghisa, alluminio, rame, bronzo, ottone, legno, plastica, fibra di vetro e cartongesso



N° DI GIRI TEORICI PER SEGHE A TAZZA IN FUNZIONE AL MATERIALE DA LAVORARE

Materiale da lavorare	Ø Sega																Refrigerante
	14 -17	19 -24	25 -32	33 -38	40 -44	46 -51	52 -57	59 -64	65 -70	73 -79	83 -89	92 -98	102 -108	111 -121	127 -140	146 -152	
	n. di giri (rpm)																
Acciaio da costruzione basso legato R < 700 ÷ 900 N/mm ²	530	360	280	230	190	170	140	130	120	110	90	80	80	70	60	50	Emulsione
Acciaio legato R < 1100 ÷ 1300 N/mm ²	210	140	110	90	80	70	60	50	50	40	40	30	30	30	20	20	Emulsione
Acciaio Inox	210	140	110	90	80	70	60	50	50	40	40	30	30	30	20	20	Emulsione
Ghisa	250	180	170	140	110	90	70	60	60	50	40	40	40	30	30	30	No refriger.
Ottone	740	510	400	320	270	230	200	180	170	150	130	120	110	100	80	70	Emulsione Olio
Alluminio e leghe leggere	850	580	450	360	300	270	230	210	190	170	150	130	120	110	100	80	Emulsione
Legno	960	650	510	410	340	300	260	230	210	190	170	150	140	120	110	100	No refriger.
Plastica	640	430	340	270	230	200	170	150	140	130	110	100	90	80	70	60	No refriger.
Cartongesso	960	650	510	410	340	300	260	230	210	190	170	150	140	120	110	100	No refriger.





0278-

PRO

SEGA A TAZZA BIMETALLICA A DENTATURA VARIABILE

Grazie alla geometria della dentatura variabile si ha una esecuzione di tagli rapidi e precisi, oltre ad una maggiore dispersione di calore durante il taglio per una minore usura dei denti. Inoltre si ha una notevole riduzione del fenomeno di grippaggio.

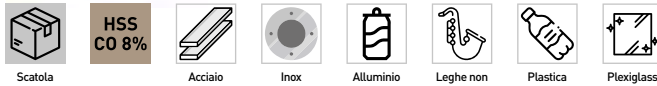

Art.	€	Ø	Ø inch
0278/014	€ 5,30	14 mm	9/16
0278/016	€ 5,30	16 mm	5/8
0278/017	€ 5,30	17 mm	11/16
0278/019	€ 5,70	19 mm	3/4
0278/020	€ 5,70	20 mm	25/32
0278/021	€ 6,10	21 mm	13/16
0278/022	€ 6,10	22 mm	7/8
0278/024	€ 6,40	24 mm	15/16
0278/025	€ 6,40	25 mm	1
0278/027	€ 7,00	27 mm	1-1/16
0278/029	€ 7,00	29 mm	1-1/8
0278/030	€ 8,30	30 mm	1-3/16
0278/032	€ 8,30	32 mm	1-1/4
0278/033	€ 8,50	33 mm	1-5/16
0278/035	€ 9,00	35 mm	1-3/8
0278/037	€ 9,50	37 mm	1-7/16
0278/038	€ 9,50	38 mm	1-1/2
0278/040	€ 9,70	40 mm	1-9/16
0278/041	€ 9,90	41 mm	1-5/8
0278/043	€ 9,90	43 mm	1-11/16
0278/044	€ 10,80	44 mm	1-3/4
0278/046	€ 10,80	46 mm	1-13/16
0278/048	€ 11,10	48 mm	1-7/8
0278/051	€ 11,40	51 mm	2
0278/052	€ 12,70	52 mm	2-1/16
0278/054	€ 12,70	54 mm	2-1/8
0278/057	€ 12,70	57 mm	2-1/4
0278/059	€ 13,10	59 mm	2-5/16
0278/060	€ 13,10	60 mm	2-3/8
0278/064	€ 14,10	64 mm	2-1/2
0278/065	€ 14,10	65 mm	2-9/16
0278/067	€ 15,20	67 mm	2-5/8
0278/068	€ 15,20	68 mm	2-11/16
0278/070	€ 15,20	70 mm	2-3/4
0278/073	€ 16,70	73 mm	2-7/8
0278/076	€ 16,70	76 mm	3
0278/079	€ 17,70	79 mm	3-1/8
0278/083	€ 18,80	83 mm	3-1/4
0278/085	€ 18,80	85 mm	3-3/8
0278/089	€ 20,40	89 mm	3-1/2
0278/092	€ 20,90	92 mm	3-5/8
0278/095	€ 21,70	95 mm	3-3/4
0278/098	€ 21,70	98 mm	3-7/8
0278/102	€ 21,90	102 mm	4
0278/105	€ 22,30	105 mm	4-1/8
0278/108	€ 23,00	108 mm	4-1/4
0278/111	€ 23,70	111 mm	4-3/8
0278/114	€ 24,80	114 mm	4-1/2
0278/121	€ 25,90	121 mm	4-3/4
0278/127	€ 28,00	127 mm	5
0278/140	€ 37,80	140 mm	5-1/2
0278/152	€ 44,00	152 mm	6

0278/002S

PRO € 95,90

ASSORTIMENTO IN VALIGETTA

Kit elettricista

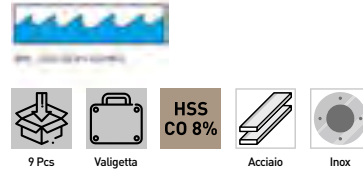

Tazze	22 - 29 mm
Alberi, punte, adattatore corrispondenti	0712/600
Tazze	35 - 44 mm
Alberi, punte, adattatore corrispondenti	0712/800
Tazze	51 - 64 mm
Alberi, punte, adattatore corrispondenti	0712/900

0278/005S

PRO € 62,90

ASSORTIMENTO IN VALIGETTA

Kit riparatore.

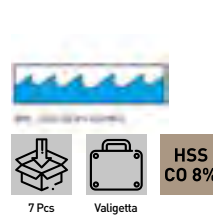

Tazze	22 - 25 - 29 mm
Alberi, punte, adattatore corrispondenti	0712/600
Tazze	32 - 38 mm
Alberi, punte, adattatore corrispondenti	0712/900

0278/008S

PRO € 91,20

ASSORTIMENTO IN VALIGETTA

Kit idraulico.

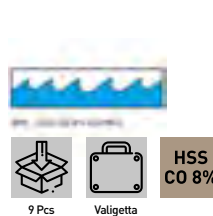

Tazze	19 - 22 - 29 mm
Alberi, punte, adattatore corrispondenti	0712/600
Tazze	38 - 44 - 57 mm
Alberi, punte, adattatore corrispondenti	0712/800 - 0712/900

0278/009S

PRO € 108,00

ASSORTIMENTO IN VALIGETTA

Kit installatore



Tazze	19 - 22 - 29 mm
Alberi, punte, adattatore corrispondenti	0712/600 - 0712/900 - 0712/300
Tazze	35 - 38 - 44 - 51 - 57 - 64 mm
Alberi, punte, adattatore corrispondenti	0712/800

0712-

SEGA A TAZZA BIMETALLICA A DENTATURA VARIABILE

Grazie alla geometria della dentatura variabile si ha una esecuzione di tagli rapidi e precisi, oltre ad una maggiore dispersione di calore durante il taglio per una minore usura dei denti. Inoltre si ha una notevole riduzione del fenomeno di grippaggio.



Modello - HSS M3
Per: 2-4-6

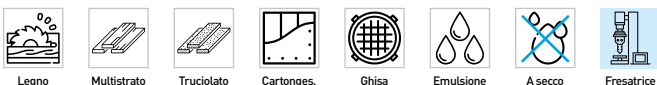
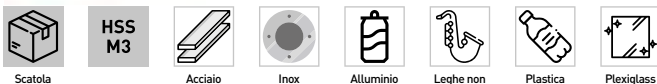

Art.	€	Ø	Ø inch
0712/014	€ 4,91	14 mm	9/16
0712/016	€ 4,91	16 mm	5/8
0712/017	€ 4,91	17 mm	11/16
0712/019	€ 4,91	19 mm	3/4
0712/020	€ 4,91	20 mm	25/32
0712/021	€ 4,91	21 mm	13/16
0712/022	€ 7,00	22 mm	7/8
0712/024	€ 7,00	24 mm	15/16
0712/025	€ 7,00	25 mm	1
0712/027	€ 7,00	27 mm	1-1/16
0712/029	€ 7,00	29 mm	1-1/8
0712/030	€ 7,10	30 mm	1-3/16
0712/032	€ 7,10	32 mm	1-1/4
0712/033	€ 7,10	33 mm	1-5/16
0712/035	€ 9,10	35 mm	1-3/8
0712/037	€ 9,10	37 mm	1-7/16
0712/038	€ 9,10	38 mm	1-1/2
0712/040	€ 9,10	40 mm	1-9/16
0712/041	€ 9,10	41 mm	1-5/8
0712/043	€ 9,10	43 mm	1-11/16
0712/044	€ 9,10	44 mm	1-3/4
0712/046	€ 9,10	46 mm	1-13/16
0712/048	€ 9,10	48 mm	1-7/8
0712/051	€ 9,10	51 mm	2
0712/052	€ 10,70	52 mm	2-1/16
0712/054	€ 10,70	54 mm	2-1/8
0712/057	€ 10,70	57 mm	2-1/4
0712/059	€ 10,70	59 mm	2-5/16
0712/060	€ 10,70	60 mm	2-3/8
0712/064	€ 12,00	64 mm	2-1/2
0712/065	€ 12,00	65 mm	2-9/16
0712/067	€ 12,00	67 mm	2-5/8
0712/068	€ 12,00	68 mm	2-11/16
0712/070	€ 12,00	70 mm	2-3/4
0712/073	€ 14,00	73 mm	2-7/8
0712/076	€ 14,00	76 mm	3
0712/079	€ 14,00	79 mm	3-1/8
0712/083	€ 15,60	83 mm	3-1/4
0712/085	€ 15,60	85 mm	3-3/8
0712/089	€ 15,60	89 mm	3-1/2
0712/092	€ 15,60	92 mm	3-5/8
0712/095	€ 17,30	95 mm	3-3/4
0712/098	€ 17,30	98 mm	3-7/8
0712/102	€ 18,50	102 mm	4
0712/105	€ 20,20	105 mm	4-1/8
0712/108	€ 24,80	108 mm	4-1/4
0712/111	€ 30,80	111 mm	4-3/8
0712/114	€ 30,80	114 mm	4-1/2
0712/121	€ 30,80	121 mm	4-3/4
0712/127	€ 30,80	127 mm	5
0712/140	€ 35,60	140 mm	5-1/2
0712/152	€ 35,60	152 mm	6

0712/002

€ 86,90

ASSORTIMENTO IN VALIGETTA

Kit elettricista



Modello - HSS M3
Per: 2-4-6



Tazze	22 - 29 mm
Alberi, punte, adattatore corrispondenti	0712/600
Tazze	35 - 44 mm
Alberi, punte, adattatore corrispondenti	0712/800
Tazze	51 - 64 mm
Alberi, punte, adattatore corrispondenti	0712/900

0712/005

€ 56,90

ASSORTIMENTO IN VALIGETTA

Kit riparatore



Modello - HSS M3
Per: 2-4-6

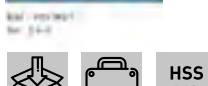

Tazze	22 - 25 - 29 mm
Alberi, punte, adattatore corrispondenti	0712/600
Tazze	32 - 38 mm
Alberi, punte, adattatore corrispondenti	0712/900

0712/008

€ 86,90

ASSORTIMENTO IN VALIGETTA

Kit idraulico



Modello - HSS M3
Per: 2-4-6



Tazze	19 - 22 - 29 mm
Alberi, punte, adattatore corrispondenti	0712/600
Tazze	38 - 44 - 57 mm
Alberi, punte, adattatore corrispondenti	0712/800 - 0712/900

0712/009

€ 98,70

ASSORTIMENTO IN VALIGETTA

Kit installatore



Modello - HSS M3
Per: 2-4-6



Tazze	19 - 22 - 29 mm
Alberi, punte, adattatore corrispondenti	0712/600 - 0712/900 - 0712/300
Tazze	35 - 38 - 44 - 51 - 57 - 64 mm
Alberi, punte, adattatore corrispondenti	0712/800



0712/010

€ 186,00

ASSORTIMENTO IN VALIGETTA

Kit industria



Max. Ø 22 mm
Max. L 294 mm



21 Pcs



Valigetta

**HSS
M3**



Tazze	19 - 22 - 29 mm
Alberi, punte, adattatore corrispondenti	0712/600 - 0712/900 - 0712/300
Tazze	35 - 38 - 44 - 51 - 57 - 64 - 76 - 83 - 92 - 95 - 105 - 114 mm
Alberi, punte, adattatore corrispondenti	0712/600 - 0712/900 - 0712/300
Prolunga	300 mm

0712-X00

PUNTA PER ALBERI

Intercambiabile con tutte le marche



Scatola

HSS

Art.	€	Gambo	Per alberi	Lunghezza	Pack
0712/300	€ 3,96	Ø 6,35 mm	0712/600	105 mm	10
0712/200	€ 3,96	Ø 6,35 mm	0712/700 - 800	75 mm	10

0712/900

€ 3,96

ADATTATORE PER SEGHE A TAZZA



Scatola

Riduzione	1/2" - 5/8"
Per alberi	0712/600 - 0712/700

0712-X0

ALBERO COMPLETO DI PUNTA

Attacco esagonale, intercambiabile con tutte le marche.



Scatola

HSS

Art.	€	Attacco	Gambo	Tazze	Filetto
0712/600	€ 7,10	Albero Tondo	Ø 6,35 mm	Ø 14÷30 mm	1/2"
0712/700	€ 8,00	Albero Esagonale	Ø 9,5 mm	Ø 14÷30 mm	1/2"
0712/800	€ 12,70	Albero Esagonale	Ø 11 mm	Ø 32÷152 mm	5/8"



A208B-

ALESATORE A MACCHINA

DIN 208/B, rettificati per accoppiamenti H7. Taglio destro, taglienti elicoidali sinistri, attacco cono morse. Utilizzabili prevalentemente per fori passanti ma grazie all'imbocco corto è possibile alesare anche fori ciechi

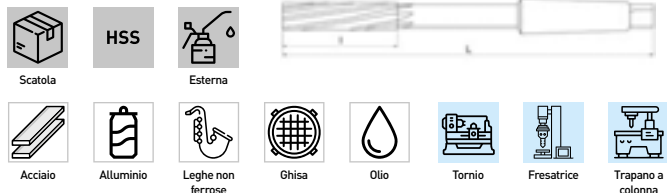

Art.	€	øH7	L	I	CM
A208B/05	€ 21,40	5 mm	133 mm	23 mm	1
A208B/06	€ 23,20	6 mm	138 mm	26 mm	1
A208B/07	€ 23,20	7 mm	150 mm	31 mm	1
A208B/08	€ 24,30	8 mm	156 mm	33 mm	1
A208B/09	€ 24,30	9 mm	162 mm	36 mm	1
A208B/10	€ 26,50	10 mm	168 mm	38 mm	1
A208B/11	€ 26,50	11 mm	175 mm	41 mm	1
A208B/12	€ 27,80	12 mm	182 mm	44 mm	1
A208B/13	€ 27,80	13 mm	182 mm	44 mm	1
A208B/14	€ 29,10	14 mm	189 mm	47 mm	1
A208B/15	€ 33,20	15 mm	204 mm	50 mm	2
A208B/16	€ 33,20	16 mm	210 mm	52 mm	2
A208B/17	€ 34,10	17 mm	214 mm	54 mm	2
A208B/18	€ 34,70	18 mm	219 mm	56 mm	2
A208B/19	€ 35,60	19 mm	223 mm	58 mm	2
A208B/20	€ 39,50	20 mm	228 mm	60 mm	2
A208B/21	€ 41,60	21 mm	232 mm	62 mm	2
A208B/22	€ 45,50	22 mm	237 mm	64 mm	2
A208B/23	€ 50,00	23 mm	241 mm	66 mm	2
A208B/24	€ 51,90	24 mm	268 mm	68 mm	3
A208B/25	€ 56,90	25 mm	268 mm	68 mm	3
A208B/26	€ 59,70	26 mm	273 mm	70 mm	3
A208B/27	€ 66,60	27 mm	277 mm	71 mm	3
A208B/28	€ 72,50	28 mm	277 mm	71 mm	3
A208B/29	€ 74,40	29 mm	281 mm	73 mm	3
A208B/30	€ 79,30	30 mm	281 mm	73 mm	3
A208B/31	€ 83,20	31 mm	285 mm	75 mm	3
A208B/32	€ 87,10	32 mm	317 mm	77 mm	4
A208B/34	€ 116,00	34 mm	321 mm	78 mm	4
A208B/35	€ 121,00	35 mm	321 mm	78 mm	4
A208B/36	€ 126,00	36 mm	325 mm	79 mm	4
A208B/38	€ 140,00	38 mm	329 mm	81 mm	4
A208B/40	€ 152,00	40 mm	329 mm	81 mm	4

A212-

ALESATORE A MACCHINA

DIN 212/B, rettificati per accoppiamenti H7. Taglio destro, taglienti elicoidali sinistri, attacco cilindrico. Utilizzabili prevalentemente per fori passanti ma grazie all'imbocco corto è possibile alesare anche fori ciechi

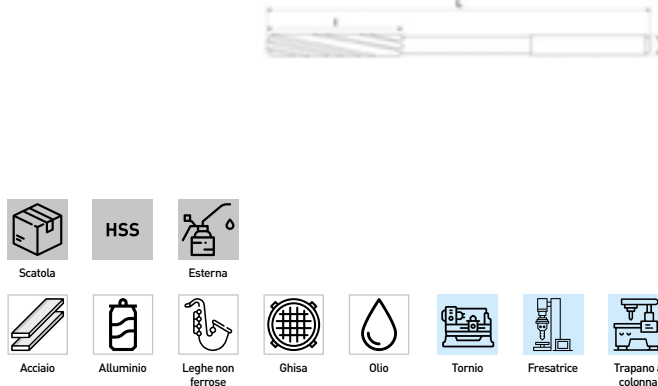

Art.	€	øH7	L	I	d h9	Z
A212/02.00	€ 20,20	2 mm	49 mm	11 mm	2 mm	4
A212/02.50	€ 20,20	2,5 mm	57 mm	14 mm	2,5 mm	4
A212/03.00	€ 20,20	3 mm	61 mm	15 mm	3 mm	4
A212/03.50	€ 20,20	3,5 mm	70 mm	18 mm	3,5 mm	6
A212/04.00	€ 13,50	4 mm	75 mm	19 mm	4 mm	6
A212/04.50	€ 13,50	4,5 mm	80 mm	21 mm	4,5 mm	6
A212/05.00	€ 13,50	5 mm	86 mm	23 mm	5 mm	6
A212/05.50	€ 13,50	5,5 mm	93 mm	26 mm	5,5 mm	6
A212/06.00	€ 13,50	6 mm	93 mm	26 mm	6 mm	6
A212/06.50	€ 17,10	6,5 mm	101 mm	28 mm	6,5 mm	6
A212/07.00	€ 17,10	7 mm	109 mm	31 mm	7 mm	6
A212/07.50	€ 17,10	7,5 mm	109 mm	31 mm	7 mm	6
A212/08.00	€ 17,10	8 mm	117 mm	33 mm	8 mm	6
A212/08.50	€ 21,30	8,5 mm	117 mm	33 mm	8 mm	6
A212/09.00	€ 21,30	9 mm	125 mm	36 mm	9 mm	6
A212/09.50	€ 21,30	9,5 mm	125 mm	36 mm	9 mm	6
A212/10.00	€ 21,30	10 mm	133 mm	38 mm	10 mm	6
A212/11.00	€ 24,30	11 mm	142 mm	41 mm	10 mm	6
A212/12.00	€ 33,20	12 mm	151 mm	44 mm	10 mm	6
A212/13.00	€ 33,20	13 mm	151 mm	44 mm	10 mm	6
A212/14.00	€ 40,10	14 mm	160 mm	47 mm	12 mm	6
A212/15.00	€ 40,10	15 mm	162 mm	50 mm	12 mm	8
A212/16.00	€ 40,10	16 mm	170 mm	52 mm	12 mm	8





L018-

LAMATORE CON ATTACCO CILINDRICO PER PREFORI DI FILETTATURE

DIN 373, per prefiori di filettature



Art.	€	Viti	D	d1	d2	L1	L2	L
L018/03	€ 12,40	M3	6 mm	2,5 mm	5 mm	4 mm	14 mm	71 mm
L018/04	€ 12,40	M4	8 mm	3,3 mm	5 mm	5 mm	14 mm	71 mm
L018/05	€ 12,40	M5	10 mm	4,2 mm	8 mm	6 mm	18 mm	80 mm
L018/06	€ 12,80	M6	11 mm	5,0 mm	8 mm	7 mm	18 mm	80 mm
L018/08	€ 20,80	M8	15 mm	6,8 mm	12,5 mm	9 mm	22 mm	100 mm
L018/10	€ 24,70	M10	18 mm	8,5 mm	12,5 mm	14 mm	22 mm	100 mm
L018/12	€ 26,70	M12	20 mm	10,2 mm	12,5 mm	14 mm	22 mm	100 mm

L019-

LAMATORE CON ATTACCO CILINDRICO GRADO FINO

DIN 373, per fori passanti per l'esecuzione di viteria o bulloneria di precisione



Art.	€	Viti	D	d1	d2	L1	L2	L
L019/03	€ 12,40	M3	6 mm	3,2 mm	5 mm	4 mm	14 mm	71 mm
L019/04	€ 12,40	M4	8 mm	4,3 mm	5 mm	5 mm	14 mm	71 mm
L019/05	€ 12,40	M5	10 mm	5,3 mm	8 mm	6 mm	18 mm	80 mm
L019/06	€ 12,80	M6	11 mm	6,4 mm	8 mm	7 mm	18 mm	80 mm
L019/08	€ 20,80	M8	15 mm	8,4 mm	12,5 mm	9 mm	22 mm	100 mm
L019/10	€ 24,70	M10	18 mm	10,5 mm	12,5 mm	14 mm	22 mm	100 mm
L019/12	€ 26,70	M12	20 mm	13,0 mm	12,5 mm	14 mm	22 mm	100 mm

L020-

LAMATORE CON ATTACCO CILINDRICO TIPO MEDIO

DIN 373, per fori passanti



Art.	€	Viti	D	d1	d2	L1	L2	L
L020/03	€ 13,50	M3	6 mm	3,4 mm	5 mm	4 mm	14 mm	71 mm
L020/04	€ 14,60	M4	8 mm	4,5 mm	5 mm	5 mm	14 mm	71 mm
L020/05	€ 15,80	M5	10 mm	5,5 mm	8 mm	6 mm	18 mm	80 mm
L020/06	€ 16,60	M6	11 mm	6,6 mm	8 mm	7 mm	18 mm	80 mm
L020/08	€ 25,30	M8	15 mm	9 mm	12,5 mm	9 mm	22 mm	100 mm
L020/10	€ 28,70	M10	18 mm	11 mm	12,5 mm	14 mm	22 mm	100 mm
L020/12	€ 32,30	M12	20 mm	13,5 mm	12,5 mm	14 mm	22 mm	100 mm

L018S

€ 84,10

SERIE LAMATORI CON ATTACCO CILINDRICO PER PREFORI DI FILETTATURE

DIN 373, per prefiori di filettature

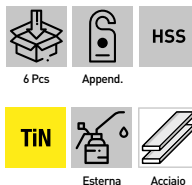

Per viti M3, M4, M5, M6, M8, M10, M12

L019S

€ 84,10

SERIE LAMATORI CON ATTACCO CILINDRICO GRADO FINO

DIN 373, per fori passanti per l'esecuzione di viteria o bulloneria di precisione

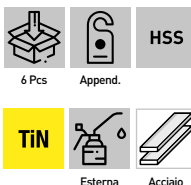

Per viti M3, M4, M5, M6, M8, M10, M12

L020S

€ 84,10

SERIE LAMATORI CON ATTACCO CILINDRICO GRADO MEDIO

DIN 373, per fori passanti



Per viti M3, M4, M5, M6, M8, M10

L020 € 98,70

SERIE LAMATORI TIPO MEDIO CON ATTACCO CILINDRICO

DIN 373, per fori passanti



Per viti M3, M4, M5, M6, M8, M10, M12

SOX

SVASATORE A 3 TAGLIANTI 90°

DIN 335C, con spoglie rettificate e scanalature ricavate dal pieno, per eseguire svasature coniche senza vibrazioni.



Art.	€	Ø max	Per Viti M	Gambo
S006	€ 10,20	6,3 mm	3	Ø 5 mm
S010	€ 12,00	10,4 mm	5	Ø 6 mm
S012	€ 13,80	12,4 mm	6	Ø 8 mm
S016	€ 17,90	16,5 mm	8	Ø 10 mm
S020	€ 21,90	20,5 mm	10	Ø 10 mm
S025	€ 26,20	25 mm	12	Ø 10 mm
S028	€ 33,10	28 mm	14	Ø 12 mm
S031	€ 35,50	31 mm	16	Ø 12 mm
S040	€ 60,00	40 mm	--	Ø 15 mm

S001 € 93,10

SERIE SVASATORE A 3 TAGLIANTI 90°

DIN 335C, con spoglie rettificate e scanalature ricavate dal pieno, per eseguire svasature coniche senza vibrazioni.

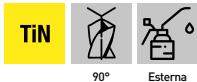

Ø max 6 - 8 - 10 - 12,4 - 16,5 - 20,5 mm

S026-

SVASATORE CON GAMBO ESAGONALE

Per eseguire svasature coniche senza vibrazioni.

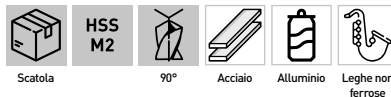

Art.	€	Ø	Lunghezza totale	Dimensioni gambo
S026/06	€ 9,40	6,3 mm	31 mm	1/4" HEX x 25 mm
S026/08	€ 9,40	8,3 mm	31 mm	1/4" HEX x 25 mm
S026/10	€ 10,30	10,4 mm	34 mm	1/4" HEX x 25 mm
S026/12	€ 10,80	12,4 mm	35 mm	1/4" HEX x 25 mm
S026/16	€ 11,80	16,5 mm	40 mm	1/4" HEX x 25 mm
S026/20	€ 13,70	20,5 mm	41 mm	1/4" HEX x 25 mm

S026/06-20S € 60,20

SERIE SVASATORI CON GAMBO ESAGONALE

Per eseguire svasature coniche senza vibrazioni.



Misure 6,3 - 8,3 - 10,4 - 12,4 - 16,5 - 20,5 mm
Dimensioni gambo 1/4" HEX x 25 mm

S026/06-20SM € 73,40

SERIE SVASATORI CON GAMBO ESAGONALE

Per eseguire svasature coniche senza vibrazioni. Con manico e prolunga magnetica.



Misure 6,3 - 8,3 - 10,4 - 12,4 - 16,5 - 20,5 mm
Dimensioni gambo 1/4" HEX x 25 mm



A014-

UTENSILE CONICO ALLARGAFORI

Con gambo cilindrico



Art.	€	Ø	Lunghezza totale
A014/03-14	€ 12,50	3 - 14 mm	58 mm
A014/06-20	€ 21,60	6 - 20 mm	63 mm
A014/16-30	€ 38,60	16 - 30,5 mm	72 mm
A014/26-40	€ 71,50	26 - 40 mm	86 mm
A014/36-50	€ 95,90	36 - 50 mm	89 mm
A014/40-61	€ 160,00	40 - 61 mm	94 mm
A014/03-31	€ 45,10	3 - 31 mm	104 mm
A014/03-22	€ 26,80	3 - 22,5 mm	76 mm

F639

€ 78,60

UTENSILE CONICO A GRADINO

Per creare e allargare fori in lamiere

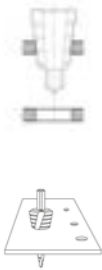

Gambo	10 mm
Ø	6 ÷ 39 (6-9-12-15-18-21-24-27-30-33-36-39) mm

F23X

UTENSILE CONICO A GRADINO

Per creare e allargare fori in lamiere, con punta intercambiabile.

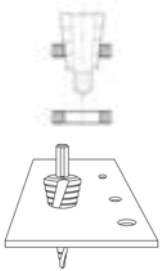

Art.	€	Gambo	Ø
F232	€ 72,40	10 mm	2,5 ÷ 32 (2,5-6,3-11,2-14,5-18,2-22,3-27,9-32) mm
F238	€ 77,50	10 mm	2,5 ÷ 38 (2,5-6,3-13-16-19-21-23-26-29-32-35-38) mm

A014/03-30S

€ 81,30

SERIE UTENSILI CONICI ALLARGAFORI

Con gambo cilindrico



Misure	3-14 - 6-20 - 16-30,5 mm
--------	--------------------------

F430

€ 74,40

SERIE UTENSILI CONICI A SCALINI

Per creare e allargare fori in lamiere



Gambo	6 - 8 - 10 mm
Ø	4 ÷ 12 - 6 ÷ 20 - 6 ÷ 30 mm

F025

€ 6,50

PUNTA DI RICAMBIO

Compatibile con F232 F238

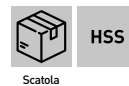

Gambo	4 mm
Punta di ricambio	Ø 2,5 mm

P037-

PUNTA FRESA

Per foratura e fresatura di materiali sottili



Art.	€	Ø	Gambo	Lunghezza totale
P037/6	€ 2,71	6 mm	6 mm	90 mm
P037/8	€ 4,06	8 mm	8 mm	90 mm

F005-

FRESA FRONTALE PER FINITURA A 2 TAGLIENTI

DIN 327/D, per finitura, gambo cilindrico, attacco weldon, serie normale

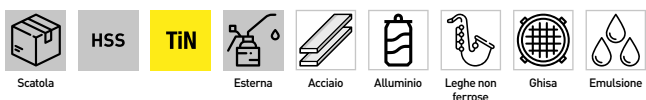

Art.	€	D	d	l	Z	L
F005/03	€ 7,50	3 mm	6 mm	5 mm	2	49 mm
F005/04	€ 7,80	4 mm	6 mm	7 mm	2	51 mm
F005/05	€ 8,80	5 mm	6 mm	8 mm	2	52 mm
F005/06	€ 9,00	6 mm	6 mm	8 mm	2	52 mm
F005/08	€ 10,80	8 mm	10 mm	11 mm	2	61 mm
F005/10	€ 10,90	10 mm	10 mm	13 mm	2	63 mm
F005/12	€ 12,70	12 mm	12 mm	16 mm	2	73 mm



Art.	€	D	d	l	Z	L
F005/14	€ 17,00	14 mm	12 mm	16 mm	2	73 mm
F005/16	€ 25,20	16 mm	16 mm	19 mm	2	79 mm
F005/18	€ 26,20	18 mm	16 mm	19 mm	2	79 mm
F005/20	€ 35,50	20 mm	20 mm	22 mm	2	88 mm
F005/22	€ 44,00	22 mm	20 mm	22 mm	2	88 mm
F005/24	€ 49,90	24 mm	20 mm	26 mm	2	92 mm
F005/25	€ 54,00	25 mm	20 mm	26 mm	2	92 mm

F006-

FRESA FRONTALE PER FINITURA A 4 TAGLIENTI

DIN 844 per finitura, gambo cilindrico, attacco weldon, serie normale

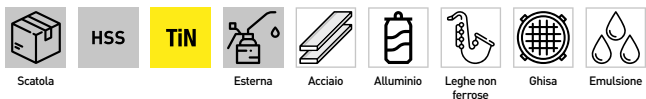

Art.	€	D	d	l	Z	L
F006/03	€ 7,80	3 mm	6 mm	8 mm	4	52 mm
F006/04	€ 7,80	4 mm	6 mm	11 mm	4	55 mm
F006/05	€ 8,90	5 mm	6 mm	13 mm	4	57 mm
F006/06	€ 9,00	6 mm	6 mm	13 mm	4	57 mm
F006/08	€ 11,30	8 mm	10 mm	19 mm	4	69 mm
F006/10	€ 11,90	10 mm	10 mm	22 mm	4	72 mm



Art.	€	D	d	l	Z	L
F006/12	€ 15,40	12 mm	12 mm	26 mm	4	83 mm
F006/14	€ 15,40	14 mm	12 mm	26 mm	4	83 mm
F006/16	€ 22,60	16 mm	16 mm	32 mm	4	92 mm
F006/18	€ 22,80	18 mm	16 mm	32 mm	4	92 mm
F006/20	€ 31,90	20 mm	20 mm	38 mm	4	104 mm

F007-

FRESA FRONTALE A 4 TAGLIENTI PER SGROSSATURA

DIN 844/B, taglio al centro, gambo cilindrico, attacco weldon, serie normale per sgrossatura passo fine.

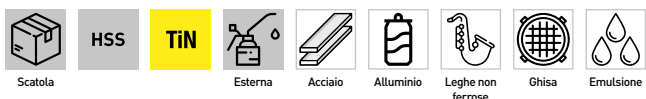

Art.	€	D	d	l	Z	L
F007/06	€ 12,70	6 mm	6 mm	13 mm	4	57 mm
F007/07	€ 12,70	7 mm	10 mm	16 mm	4	66 mm
F007/08	€ 14,00	8 mm	10 mm	19 mm	4	69 mm
F007/09	€ 16,30	9 mm	10 mm	19 mm	4	69 mm
F007/10	€ 16,30	10 mm	10 mm	22 mm	4	72 mm
F007/11	€ 16,30	11 mm	12 mm	22 mm	4	76 mm
F007/12	€ 16,30	12 mm	12 mm	26 mm	4	83 mm
F007/13	€ 17,50	13 mm	12 mm	26 mm	4	83 mm



Art.	€	D	d	l	Z	L
F007/14	€ 17,50	14 mm	12 mm	26 mm	4	83 mm
F007/15	€ 22,10	15 mm	12 mm	26 mm	4	83 mm
F007/16	€ 22,10	16 mm	16 mm	32 mm	4	92 mm
F007/18	€ 30,30	18 mm	16 mm	32 mm	4	92 mm
F007/20	€ 41,10	20 mm	20 mm	38 mm	4	104 mm
F007/22	€ 47,10	22 mm	20 mm	38 mm	4	104 mm
F007/25	€ 52,10	25 mm	25 mm	45 mm	4	121 mm



F001/10

€ 228,00

SERIE FRESE FRONTALI A SGROSSARE

DIN 844/B, taglio al centro, gambo cilindrico, attacco weldon, serie normale



Fresa	Ø 6 8 10 12 14 16 18 20 22 25 mm
Gambo	Ø 6 10 10 12 12 16 16 20 20 25 mm

F001/20

€ 228,00

SERIE FRESE FRONTALI PER FINITURA

DIN 844/B e DIN 327/D, a 2 e 4 taglienti, taglio al centro, gambo cilindrico, attacco weldon, serie normale.



Fresa 2 T	Ø 3 - 4 - 5 - 6 - 8 - 10 - 12 - 14 - 18 - 20 mm
Gambo	Ø 6 - 6 - 6 - 6 - 10 - 10 - 12 - 12 - 16 - 20 mm
Fresa 4 T	Ø 3 - 4 - 5 - 6 - 8 - 10 - 12 - 14 - 18 - 20 mm
Gambo	Ø 6 - 6 - 6 - 6 - 10 - 10 - 12 - 12 - 16 - 20 mm



FRESE ROTATIVE IN METALLO DURO

Tipologia di taglio	Rappresentazione	Descrizione
Taglio Standard		Tipologia di taglio adatta per acciaio, acciaio temprato, ghisa, cordoni di saldatura e materiali metallici in generale.
Taglio incrociato		Tipologia di taglio adatta per acciai trattati, acciaio inox, materiali metallici in generale. Grazie a questa tipologia di taglio le vibrazioni sono notevolmente ridotte
Taglio Alluminio		Tipologia di taglio adatta per alluminio, magnesio, plastiche e gomma dura.

TIPOLOGIE DI FORME ED IL LORO UTILIZZO

Cilindrica senza taglio frontale 	Cilindrica a taglio frontale 	Cilindrica a testa raggata 	Sferica
Ovale 	Ogiva a punta arrotondata 	Ogiva 	A lancia raggata
Conica a punta raggata 	Conica a punta 	Tronco coniche 	Conica a 90°
Conica a 60° 			

AXSC FRESE ROTATIVE A TAGLIO SINGOLO

Scatola

HM

Acciaio

Ghisa

A secco

Smerigl. assiale

Art.	€	D1	L1	D2	L2
A02SC3	€ 4,45	ø2 mm	10 mm	3 mm	38 mm
A06SC6	€ 12,40	ø6 mm	16 mm	6 mm	61 mm
A08SC6	€ 13,90	ø8 mm	20 mm	6 mm	65 mm
A10SC6	€ 17,30	ø10 mm	20 mm	6 mm	65 mm
A12SC6	€ 25,30	ø12 mm	25 mm	6 mm	70 mm
A16SC6	€ 39,50	ø16 mm	25 mm	6 mm	70 mm

AXDC FRESE ROTATIVE A TAGLIO DIAMANTE

Scatola

HM

Acciaio

Inox

Ghisa

A secco

Art.	€	D1	L1	D2	L2
A02DC3	€ 4,45	ø2 mm	10 mm	3 mm	38 mm
A06DC6	€ 12,40	ø6 mm	16 mm	6 mm	61 mm
A08DC6	€ 13,90	ø8 mm	20 mm	6 mm	65 mm
A10DC6	€ 17,30	ø10 mm	20 mm	6 mm	65 mm
A12DC6	€ 25,30	ø12 mm	25 mm	6 mm	70 mm
A16DC6	€ 39,50	ø16 mm	25 mm	6 mm	70 mm



A12AL6

€ 29,20

FRESE ROTATIVE PER ALLUMINIO



D1	ø12 mm
L1	25 mm
D2	6 mm
L2	70 mm

BXDC

FRESE ROTATIVE A TAGLIO DIAMANTE



Art.	€	D1	L1	D2	L2
B02DC3	€ 4,45	ø2 mm	10 mm	3 mm	38 mm
B03DC3	€ 4,45	ø3 mm	13 mm	3 mm	38 mm
B04DC3	€ 9,40	ø4 mm	13 mm	3 mm	41 mm
B04DC6	€ 9,90	ø4 mm	13 mm	6 mm	58 mm
B06DC6	€ 12,40	ø6 mm	16 mm	6 mm	61 mm
B08DC6	€ 13,90	ø8 mm	20 mm	6 mm	65 mm
B10DC6	€ 17,30	ø10 mm	20 mm	6 mm	65 mm
B12DC6	€ 25,30	ø12 mm	25 mm	6 mm	70 mm
B16DC6	€ 39,50	ø16 mm	25 mm	6 mm	70 mm
B19DC6	€ 57,40	ø19 mm	25 mm	6 mm	70 mm
B22DC6	€ 88,10	ø22 mm	25 mm	6 mm	70 mm
B25DC6	€ 102,00	ø25 mm	25 mm	6 mm	70 mm

BXSCXL

FRESE ROTATIVE A TAGLIO SINGOLO LUNGHE



Art.	€	D1	L1	D2	L2
B02SC3L	€ 5,80	ø2 mm	10 mm	3 mm	65 mm
B03SC3L	€ 5,80	ø3 mm	13 mm	3 mm	65 mm
B08SC6L	€ 17,80	ø8 mm	20 mm	6 mm	120 mm
B10SC6L	€ 22,30	ø10 mm	20 mm	6 mm	120 mm
B12SC6L	€ 27,20	ø12 mm	25 mm	6 mm	120 mm

BXSC

FRESE ROTATIVE A TAGLIO SINGOLO



Art.	€	D1	L1	D2	L2
B02SC3	€ 4,45	ø2 mm	10 mm	3 mm	38 mm
B03SC3	€ 4,45	ø3 mm	13 mm	3 mm	38 mm
B04SC3	€ 9,40	ø4 mm	13 mm	3 mm	41 mm
B04SC6	€ 9,90	ø4 mm	13 mm	6 mm	58 mm
B06SC6	€ 12,40	ø6 mm	16 mm	6 mm	61 mm
B08SC6	€ 13,90	ø8 mm	20 mm	6 mm	65 mm
B10SC6	€ 17,30	ø10 mm	20 mm	6 mm	65 mm
B12SC6	€ 25,30	ø12 mm	25 mm	6 mm	70 mm
B16SC6	€ 39,50	ø16 mm	25 mm	6 mm	70 mm

BXAL

FRESE ROTATIVE PER ALLUMINIO



Art.	€	D1	L1	D2	L2
B06AL6	€ 14,40	ø6 mm	16 mm	6 mm	61 mm
B08AL6	€ 16,40	ø8 mm	20 mm	6 mm	65 mm
B10AL6	€ 19,80	ø10 mm	20 mm	6 mm	65 mm
B12AL6	€ 28,70	ø12 mm	25 mm	6 mm	70 mm

BXDCXL

FRESE ROTATIVE IN MD TAGLIO DIAMANTE LUNGO

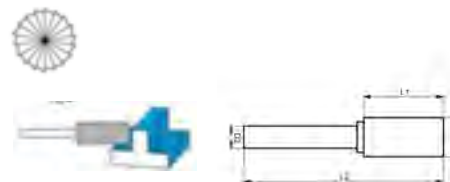

Art.	€	D1	L1	D2	L2
B02DC3L	€ 5,80	ø2 mm	10 mm	3 mm	65 mm
B03DC3L	€ 5,80	ø3 mm	13 mm	3 mm	65 mm
B08DC6L	€ 17,80	ø8 mm	20 mm	6 mm	120 mm
B10DC6L	€ 22,30	ø10 mm	20 mm	6 mm	120 mm
B12DC6L	€ 27,20	ø12 mm	25 mm	6 mm	120 mm

CXSC

FRESE ROTATIVE A TAGLIO SINGOLO

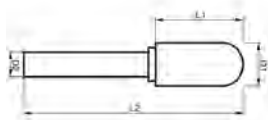

Art.	€	D1	L1	D2	L2
C02SC3	€ 4,45	ø2 mm	10 mm	3 mm	38 mm
C03SC3	€ 4,45	ø3 mm	13 mm	3 mm	38 mm
C04SC3	€ 9,40	ø4 mm	13 mm	3 mm	58 mm
C04SC6	€ 9,90	ø4 mm	13 mm	6 mm	58 mm
C06SC6	€ 12,40	ø6 mm	16 mm	6 mm	61 mm
C08SC6	€ 13,90	ø8 mm	20 mm	6 mm	65 mm
C10SC6	€ 17,30	ø10 mm	20 mm	6 mm	65 mm
C12SC6	€ 25,30	ø12 mm	25 mm	6 mm	70 mm
C16SC6	€ 39,50	ø16 mm	25 mm	6 mm	70 mm

CXAL

FRESE ROTATIVE PER ALLUMINIO



Art.	€	D1	L1	D2	L2
C06AL6	€ 13,90	ø6 mm	16 mm	6 mm	61 mm
C08AL6	€ 16,40	ø8 mm	20 mm	6 mm	65 mm
C10AL6	€ 19,80	ø10 mm	20 mm	6 mm	65 mm
C12AL6	€ 28,70	ø12 mm	25 mm	6 mm	70 mm

DXDC

FRESE ROTATIVE A TAGLIO DIAMANTE



Art.	€	D1	L1	D2	L2
D03DC3	€ 4,45	ø3 mm	2.7 mm	3 mm	38 mm
D04DC6	€ 9,90	ø4 mm	3.6 mm	6 mm	38 mm
D06DC6	€ 9,90	ø6 mm	5.4 mm	6 mm	50 mm
D08DC6	€ 10,90	ø8 mm	7.2 mm	6 mm	52 mm
D10DC6	€ 14,40	ø10 mm	9 mm	6 mm	54 mm
D12DC6	€ 20,30	ø12 mm	10.8 mm	6 mm	56 mm
D16DC6	€ 27,70	ø16 mm	14.4 mm	6 mm	60 mm
D19DC6	€ 57,40	ø19 mm	17.4 mm	6 mm	64 mm

CXDC

FRESE ROTATIVE A TAGLIO DIAMANTE



Art.	€	D1	L1	D2	L2
C02DC3	€ 4,45	ø2 mm	10 mm	3 mm	38 mm
C03DC3	€ 4,45	ø3 mm	13 mm	3 mm	38 mm
C04DC3	€ 9,40	ø4 mm	13 mm	3 mm	38 mm
C04DC6	€ 9,90	ø4 mm	13 mm	6 mm	38 mm
C06DC6	€ 12,40	ø6 mm	16 mm	6 mm	61 mm
C08DC6	€ 13,90	ø8 mm	20 mm	6 mm	65 mm
C10DC6	€ 17,30	ø10 mm	20 mm	6 mm	65 mm
C12DC6	€ 25,30	ø12 mm	25 mm	6 mm	70 mm
C16DC6	€ 39,50	ø16 mm	25 mm	6 mm	70 mm
C19DC6	€ 57,40	ø19 mm	25 mm	6 mm	70 mm
C22DC6	€ 88,10	ø22 mm	25 mm	6 mm	70 mm
C25DC6	€ 102,00	ø25 mm	25 mm	6 mm	70 mm

DXSC

FRESE ROTATIVE A TAGLIO SINGOLO



Art.	€	D1	L1	D2	L2
D03SC3	€ 4,45	ø3 mm	2.7 mm	3 mm	38 mm
D04SC6	€ 9,90	ø4 mm	3.6 mm	6 mm	38 mm
D06SC6	€ 9,90	ø6 mm	5.4 mm	6 mm	50 mm
D08SC6	€ 10,90	ø8 mm	7.2 mm	6 mm	52 mm
D10SC6	€ 14,40	ø10 mm	9 mm	6 mm	54 mm
D12SC6	€ 20,30	ø12 mm	10.8 mm	6 mm	56 mm
D16SC6	€ 27,70	ø16 mm	14.4 mm	6 mm	60 mm

DXAL

FRESE ROTATIVE PER ALLUMINIO



Art.	€	D1	L1	D2	L2
D06AL6	€ 11,40	ø6 mm	5.4 mm	6 mm	50 mm
D08AL6	€ 11,90	ø8 mm	7.2 mm	6 mm	52 mm
D10AL6	€ 16,90	ø10 mm	9 mm	6 mm	54 mm



EXSC

FRESE ROTATIVE A TAGLIO SINGOLO



Art.	€	D1	L1	D2	L2
E08SC6	€ 13,90	ø8 mm	13 mm	6 mm	58 mm
E10SC6	€ 17,30	ø10 mm	16 mm	6 mm	61 mm
E12SC6	€ 25,30	ø12 mm	20 mm	6 mm	65 mm
E16SC6	€ 39,50	ø16 mm	25 mm	6 mm	70 mm

EXDC

FRESE ROTATIVE A TAGLIO DIAMANTE

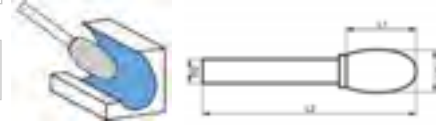
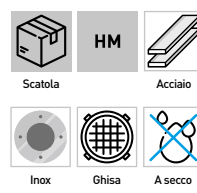

Art.	€	D1	L1	D2	L2
E08DC6	€ 13,90	ø8 mm	13 mm	6 mm	58 mm
E10DC6	€ 17,30	ø10 mm	16 mm	6 mm	61 mm
E12DC6	€ 25,30	ø12 mm	20 mm	6 mm	65 mm
E16DC6	€ 39,50	ø16 mm	25 mm	6 mm	70 mm

EXAL

FRESE ROTATIVE PER ALLUMINIO



Art.	€	D1	L1	D2	L2
E10AL6	€ 19,80	10 mm	16 mm	6 mm	61 mm
E12AL6	€ 29,20	12 mm	20 mm	6 mm	65 mm

FXSC

FRESE ROTATIVE A TAGLIO SINGOLO

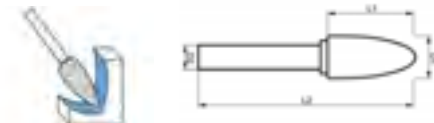

Art.	€	D1	D2	L1	L2
F03SC3	€ 4,45	ø3 mm	13 mm	3 mm	38 mm
F06SC6	€ 12,40	ø6 mm	18 mm	6 mm	63 mm
F08SC6	€ 13,90	ø8 mm	20 mm	6 mm	65 mm
F10SC6	€ 17,30	ø10 mm	20 mm	6 mm	65 mm
F12SC6	€ 25,30	ø12 mm	25 mm	6 mm	70 mm

FXDC

FRESE ROTATIVE A TAGLIO DIAMANTE

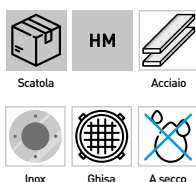

Art.	€	D1	D2	L1	L2
F03DC3	€ 4,45	ø3 mm	13 mm	3 mm	38 mm
F06DC6	€ 12,40	ø6 mm	18 mm	6 mm	63 mm
F08DC6	€ 13,90	ø8 mm	20 mm	6 mm	65 mm
F10DC6	€ 17,30	ø10 mm	20 mm	6 mm	65 mm
F12DC6	€ 25,30	ø12 mm	25 mm	6 mm	70 mm
F16DC6	€ 39,50	ø16 mm	25 mm	6 mm	70 mm
F19DC6	€ 57,40	ø19 mm	25 mm	6 mm	70 mm

FXAL

FRESE ROTATIVE PER ALLUMINIO



Art.	€	D1	L1	D2	L2
F10AL6	€ 19,80	ø10 mm	20 mm	6 mm	65 mm
F12AL6	€ 29,20	ø12 mm	25 mm	6 mm	70 mm

GXSC

FRESE ROTATIVE A TAGLIO SINGOLO



Art.	€	D1	L1	D2	L2
G03SC3	€ 4,45	ø3 mm	13 mm	3 mm	38 mm
G06SC6	€ 12,40	ø6 mm	18 mm	6 mm	65 mm
G10SC6	€ 17,30	ø10 mm	20 mm	6 mm	65 mm
G12SC6	€ 25,30	ø12 mm	25 mm	6 mm	70 mm

GXDC

FRESE ROTATIVE A TAGLIO DIAMANTE

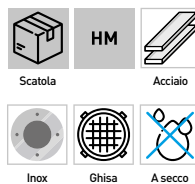

Art.	€	D1	L1	D2	L2
G03DC3	€ 4,45	ø3 mm	13 mm	3 mm	38 mm
G06DC6	€ 12,40	ø6 mm	18 mm	6 mm	65 mm
G10DC6	€ 17,30	ø10 mm	20 mm	6 mm	65 mm
G12DC6	€ 25,30	ø12 mm	25 mm	6 mm	70 mm
G16DC6	€ 39,50	ø16 mm	25 mm	6 mm	70 mm
G19DC6	€ 57,40	ø19 mm	25 mm	6 mm	70 mm

GXAL

FRESE ROTATIVE PER ALLUMINIO



Art.	€	D1	L1	D2	L2
G10AL6	€ 19,80	ø10 mm	20 mm	6 mm	65 mm
G12AL6	€ 29,20	ø12 mm	25 mm	6 mm	70 mm

HXSC

FRESE ROTATIVE A TAGLIO SINGOLO



Art.	€	D1	L1	D2	L2
H08SC6	€ 13,40	ø8 mm	20 mm	6 mm	65 mm
H10SC6	€ 15,30	ø10 mm	25 mm	6 mm	70 mm
H12SC6	€ 28,70	ø12 mm	32 mm	6 mm	77 mm

HXDC

FRESE ROTATIVE A TAGLIO DIAMANTE

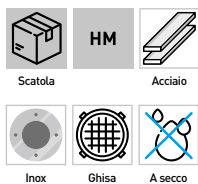

Art.	€	D1	D2	L1	L2
H06DC6	€ 12,40	ø6 mm	16 mm	6 mm	61 mm
H08DC6	€ 13,40	ø8 mm	20 mm	6 mm	65 mm
H10DC6	€ 15,30	ø10 mm	25 mm	6 mm	70 mm
H12DC6	€ 28,70	ø12 mm	32 mm	6 mm	77 mm

HXAL

FRESE ROTATIVE PER ALLUMINIO



Art.	€	D1	D2	L1	L2
H08AL6	€ 15,30	ø8 mm	20 mm	6 mm	65 mm
H10AL6	€ 19,80	ø10 mm	25 mm	6 mm	70 mm
H12AL6	€ 33,60	ø12 mm	32 mm	6 mm	77 mm



LXSC

FRESE ROTATIVE A TAGLIO SINGOLO



Art.	€	D1	L1	D2	L2
L03SC3	€ 4,45	ø3 mm	13 mm	3 mm	38 mm
L06SC6	€ 12,40	ø6 mm	16 mm	6 mm	61 mm

LXDC

FRESE ROTATIVE A TAGLIO DIAMANTE

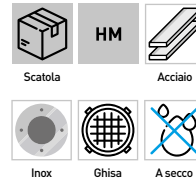

Art.	€	D1	L1	D2	L2
L03DC3	€ 4,45	ø3 mm	13 mm	3 mm	38 mm
L06DC6	€ 12,40	ø6 mm	16 mm	6 mm	61 mm
L08DC6	€ 14,80	ø8 mm	22 mm	6 mm	65 mm
L10DC6	€ 18,80	ø10 mm	25 mm	6 mm	70 mm
L12DC6	€ 25,30	ø12 mm	25 mm	6 mm	70 mm

L10AL6

€ 19,80

FRESE ROTATIVE PER ALLUMINIO



D1	ø10 mm
L1	25 mm
D2	6 mm
L2	70 mm

MXSC

FRESE ROTATIVE A TAGLIO SINGOLO

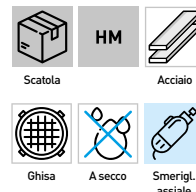

Art.	€	D1	L1	D2	L2
M08SC6	€ 13,90	ø8 mm	20 mm	6 mm	65 mm
M10SC6	€ 17,80	ø10 mm	20 mm	6 mm	65 mm
M12SC6	€ 25,30	ø12 mm	25 mm	6 mm	70 mm

MXDC

FRESE ROTATIVE A TAGLIO DIAMANTE

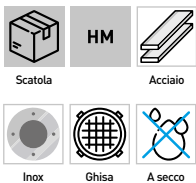

Art.	€	D1	L1	D2	L2
M03DC3	€ 4,45	ø3 mm	11 mm	3 mm	38 mm
M03DC6	€ 8,30	ø3 mm	11 mm	6 mm	38 mm
M06DC6	€ 12,40	ø6 mm	18 mm	6 mm	60 mm
M08DC6	€ 13,90	ø8 mm	20 mm	6 mm	65 mm
M10DC6	€ 17,80	ø10 mm	20 mm	6 mm	65 mm
M12DC6	€ 25,30	ø12 mm	25 mm	6 mm	70 mm
M16DC6	€ 39,50	ø16 mm	25 mm	6 mm	70 mm

M10AL6

€ 18,80

FRESE ROTATIVE PER ALLUMINIO



D1	ø10 mm
L1	20 mm
D2	6 mm
L2	65 mm

NXSC

FRESE ROTATIVE A TAGLIO SINGOLO



Art.	€	D1	L1	D2	L2
N12SC6	€ 25,30	ø12 mm	13 mm	6 mm	58 mm
N16SC6	€ 35,60	ø16 mm	16 mm	6 mm	58 mm

N12DC6

€ 25,30

FRESE ROTATIVE A TAGLIO DIAMANTE

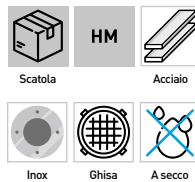

D1	ø12 mm
L1	13 mm
D2	6 mm
L2	58 mm

JXSC

FRESE ROTATIVE A TAGLIO SINGOLO



Art.	€	D1	L1	D2	L2
J03SC3	€ 4,45	ø3 mm	2.5 mm	3 mm	38 mm
J06SC6	€ 12,40	ø6 mm	5.2 mm	6 mm	54 mm
J10SC6	€ 17,30	ø10 mm	8 mm	6 mm	58 mm
J16SC6	€ 39,50	ø16 mm	13 mm	6 mm	62 mm

JXDC

FRESE ROTATIVE A TAGLIO DIAMANTE



Art.	€	D1	L1	D2	L2
J03DC3	€ 4,45	ø3 mm	2.5 mm	3 mm	38 mm
J06DC6	€ 12,40	ø6 mm	5.2 mm	6 mm	54 mm
J10DC6	€ 17,30	ø10 mm	8 mm	6 mm	58 mm
J16DC6	€ 39,50	ø16 mm	13 mm	6 mm	62 mm

KXSC

FRESE ROTATIVE A TAGLIO SINGOLO



Art.	€	D1	L1	D2	L2
K10SC6	€ 17,30	ø10 mm	5 mm	6 mm	54 mm
K16SC6	€ 35,60	ø16 mm	8 mm	6 mm	58 mm

KXDC

FRESE ROTATIVE A TAGLIO DIAMANTE

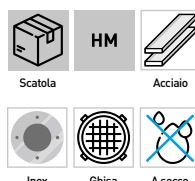

Art.	€	D1	L1	D2	L2
K10DC6	€ 17,30	ø10 mm	5 mm	6 mm	54 mm
K16DC6	€ 35,60	ø16 mm	8 mm	6 mm	58 mm



F008DC

€ 64,30

SERIE FRESE ROTATIVE IN METALLO DURO

A taglio a diamante.



Misure	10 x 20 mm
Tipo	B, C, D, G, M
Gambo	6 mm

F008SC

€ 64,30

SERIE FRESE ROTATIVE IN METALLO DURO

A taglio singolo.



Misure	10 x 20 mm
Tipo	B, C, D, G, M
Gambo	6 mm

F008-

FRESE ROTATIVE

In metallo duro con taglio incrociato



Art.	€	Gambo
F008/3	€ 60,00	Ø 3 mm
F008/6	€ 102,00	Ø 6 mm



C003-
COLTELLO STOZZATORE NORMALE A DISCO

DIN 1829, forma base foro 44,45 mm angolo di pressione 20° classe a.

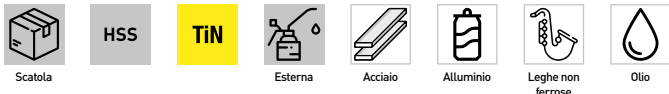

Art.	€	Modulo	∅ max	∅ d0	Altezza b1	Denti
C003/1	€ 328,00	1,00	102 mm	100 mm	16 mm	100
C003/1.25	€ 328,00	1,25	105 mm	100 mm	16 mm	80
C003/1.50	€ 356,00	1,50	107 mm	102 mm	18 mm	68
C003/1.75	€ 385,00	1,75	107,4 mm	101,5 mm	20 mm	58
C003/2	€ 385,00	2,00	107,31 mm	100 mm	20 mm	50
C003/2.25	€ 385,00	2,25	109,29 mm	101,25 mm	20 mm	45
C003/2.50	€ 440,00	2,50	108,46 mm	100 mm	20 mm	40
C003/2.75	€ 440,00	2,75	108,36 mm	99 mm	24 mm	36
C003/3	€ 440,00	3,00	111,82 mm	99 mm	24 mm	33
C003/3.25	€ 483,00	3,25	110,99 mm	99 mm	24 mm	31
C003/3.50	€ 483,00	3,50	108,72 mm	101,5 mm	24 mm	29
C003/3.75	€ 483,00	3,75	112,35 mm	101,5 mm	24 mm	27
C003/4	€ 483,00	4,00	111,75 mm	100 mm	24 mm	25
C003/4.25	€ 514,00	4,25	114,12 mm	102 mm	24 mm	24
C003/4.50	€ 514,00	4,50	111,65 mm	99 mm	24 mm	22
C003/5	€ 524,00	5,00	114,05 mm	100 mm	24 mm	20
C003/5.50	€ 556,00	5,50	119,96 mm	99 mm	24 mm	18
C003/6	€ 556,00	6,00	118,86 mm	102 mm	24 mm	17
C003/6.50	€ 697,00	6,50	122,5 mm	112 mm	24 mm	16
C003/7	€ 811,00	7,00	127 mm	105 mm	24 mm	15
C003/8	€ 911,00	8,00	135 mm	112 mm	24 mm	14
C003/10	€ 1250,00	10,00	168 mm	140 mm	24 mm	14

C001-
CREATORE PER INGRANAGGI CILINDRICI CON ANGOLO DI PRESSIONE 20°

DIN 8002/B, profilo rettificato finitore classe a.



Art.	€	Modulo	Diametro ∅	Lunghezza	Foro
C001/1	€ 362,00	1,00	50 mm	31 mm	22 mm
C001/1.25	€ 362,00	1,25	50 mm	31 mm	22 mm
C001/1.50	€ 362,00	1,50	53 mm	50 mm	22 mm
C001/1.75	€ 362,00	1,75	56 mm	38 mm	22 mm
C001/2	€ 373,00	2,00	63 mm	46 mm	27 mm
C001/2.25	€ 431,00	2,25	70 mm	56 mm	27 mm
C001/2.50	€ 431,00	2,50	71 mm	63 mm	27 mm
C001/2.75	€ 431,00	2,75	70 mm	56 mm	27 mm
C001/3	€ 524,00	3,00	80 mm	71 mm	32 mm
C001/3.25	€ 611,00	3,25	80 mm	69 mm	32 mm
C001/3.50	€ 636,00	3,50	80 mm	71 mm	32 mm
C001/3.75	€ 729,00	3,75	90 mm	78 mm	32 mm
C001/4	€ 729,00	4,00	90 mm	78 mm	32 mm
C001/4.25	€ 794,00	4,25	90 mm	78 mm	32 mm
C001/4.50	€ 794,00	4,50	90 mm	78 mm	32 mm
C001/5	€ 794,00	5,00	100 mm	88 mm	32 mm
C001/5.50	€ 794,00	5,50	100 mm	88 mm	32 mm
C001/6	€ 1050,00	6,00	110 mm	108 mm	40 mm
C001/6.50	€ 1110,00	6,50	110 mm	109 mm	40 mm
C001/7	€ 1110,00	7,00	110 mm	110 mm	40 mm
C001/8	€ 1750,00	8,00	125 mm	130 mm	40 mm
C001/9	€ 1990,00	9,00	125 mm	140 mm	40 mm
C001/10	€ 2690,00	10,00	140 mm	160 mm	40 mm
C001/12	€ 3860,00	12,00	170 mm	195 mm	50 mm
C001/13	€ 4060,00	13,00	180 mm	210 mm	50 mm



P049-

PUNTA PER MURO

DIN 8039, serie corta, attacco cilindrico, con inserto in metallo duro



C45

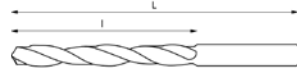

Mattoni

Calcestr.

Pietre

Ceramica

Cartonges.

Percuss.

Trapano Portatile

Art.	€	ø	L	l	Gambo	Pack
P049/03	€ 0,41	3 mm	70 mm	40 mm	ø 2,5 mm	10
P049/04	€ 0,43	4 mm	75 mm	40 mm	ø 3,5 mm	10
P049/05	€ 0,47	5 mm	85 mm	40 mm	ø 4,5 mm	10
P049/06	€ 0,53	6 mm	100 mm	55 mm	ø 4,5 mm	10
P049/07	€ 0,76	7 mm	100 mm	55 mm	ø 6,5 mm	10
P049/08	€ 0,83	8 mm	120 mm	70 mm	ø 6,5 mm	10
P049/09	€ 0,97	9 mm	120 mm	70 mm	ø 6,5 mm	10
P049/10	€ 1,10	10 mm	120 mm	70 mm	ø 7 mm	10
P049/11	€ 1,85	11 mm	150 mm	90 mm	ø 7 mm	10
P049/12	€ 1,87	12 mm	150 mm	90 mm	ø 9 mm	10
P049/13	€ 2,11	13 mm	150 mm	90 mm	ø 9 mm	5
P049/14	€ 2,38	14 mm	150 mm	90 mm	ø 11 mm	5
P049/15	€ 3,08	15 mm	150 mm	90 mm	ø 12 mm	5
P049/16	€ 3,11	16 mm	150 mm	90 mm	ø 12 mm	5
P049/18	€ 5,60	18 mm	160 mm	100 mm	ø 13 mm	5
P049/22	€ 8,00	22 mm	160 mm	100 mm	ø 13 mm	5
P049/24	€ 9,50	24 mm	160 mm	100 mm	ø 13 mm	5

P051-

PUNTA PER MARMO E GRANITO

DIN 8039, attacco cilindrico, specifica per la foratura di marmo e granito con inserto in metallo duro per rotopercolazione

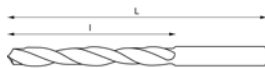

C45

HM

Granito

Marmo

Percuss.

Trapano Portatile

Art.	€	ø	L	l	Gambo	Pack
P051/03	€ 2,74	3 mm	70 mm	40 mm	ø 2,5 mm	10
P051/04	€ 2,77	4 mm	75 mm	40 mm	ø 3,5 mm	10
P051/05	€ 3,09	5 mm	85 mm	40 mm	ø 4,5 mm	10
P051/06	€ 3,39	6 mm	100 mm	55 mm	ø 5,5 mm	10
P051/07	€ 3,39	7 mm	100 mm	55 mm	ø 5,5 mm	10
P051/08	€ 3,80	8 mm	120 mm	70 mm	ø 6,5 mm	5
P051/09	€ 4,05	9 mm	120 mm	70 mm	ø 8 mm	5
P051/10	€ 4,72	10 mm	120 mm	70 mm	ø 9 mm	5
P051/12	€ 5,50	12 mm	150 mm	90 mm	ø 10 mm	5
P051/14	€ 7,00	14 mm	150 mm	90 mm	ø 12 mm	5
P051/16	€ 7,90	16 mm	150 mm	90 mm	ø 12 mm	5

P050-

PUNTA PER MURO

DIN 8039, serie lunga, attacco cilindrico, con inserto in metallo duro



C45

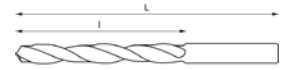

Mattoni

Calcestr.

Pietre

Ceramica

Cartonges.

Percuss.

Trapano Portatile

Art.	€	ø	L	l	Gambo	Pack
P050/06	€ 1,99	6 mm	400 mm	240 mm	ø 4,5 mm	5
P050/08	€ 2,32	8 mm	400 mm	240 mm	ø 7 mm	5
P050/09	€ 2,84	9 mm	400 mm	240 mm	ø 7 mm	5
P050/10	€ 3,39	10 mm	400 mm	240 mm	ø 7 mm	5
P050/12	€ 4,72	12 mm	400 mm	240 mm	ø 9 mm	5
P050/14	€ 5,70	14 mm	400 mm	240 mm	ø 10 mm	5
P050/16	€ 6,40	16 mm	400 mm	240 mm	ø 12 mm	5
P050/18	€ 7,80	18 mm	400 mm	240 mm	ø 12,5 mm	5
P050/20	€ 9,90	20 mm	400 mm	240 mm	ø 12,5 mm	5

P063-

PUNTA PER MURO

2 taglienti, attacco sds-plus, doppia elica per facilitare la fuoriuscita dei detriti, con inserto in metallo duro



HM

40 Cr



Mattoni

Calcestr.

Pietre

Ceramica

Cartonges.

Percuss.

Trapano Portatile

Art.	€	Misura	Pack
P063/5110	€ 3,17	5 x 110 mm	10
P063/6110	€ 3,17	6 x 110 mm	10
P063/6160	€ 3,17	6 x 160 mm	10
P063/8110	€ 3,17	8 x 110 mm	10
P063/8160	€ 3,17	8 x 160 mm	10
P063/9160	€ 3,17	9 x 160 mm	10
P063/10160	€ 3,81	10 x 160 mm	10
P063/12160	€ 3,81	12 x 160 mm	10
P063/12300	€ 4,43	12 x 300 mm	10
P063/14160	€ 4,43	14 x 160 mm	10
P063/14300	€ 4,43	14 x 300 mm	10
P063/15160	€ 5,10	15 x 160 mm	10
P063/16160	€ 5,10	16 x 160 mm	10
P063/16300	€ 5,10	16 x 300 mm	10
P063/16450	€ 9,50	16 x 450 mm	5
P063/18160	€ 7,00	18 x 160 mm	5
P063/18300	€ 7,00	18 x 300 mm	5
P063/18450	€ 10,40	18 x 450 mm	5
P063/20160	€ 7,00	20 x 160 mm	5
P063/20450	€ 10,40	20 x 450 mm	5
P063/22450	€ 12,30	22 x 450 mm	5
P063/24450	€ 13,90	24 x 450 mm	5

0332

€ 33,90

SERIE PUNTE CON INSERTO IN METALLO DURO E SCALPELLI PER MURO

Con attacco SDS PLUS, composta da 9 punte: Ø4 x 110mm Ø5 x 110mm Ø6 x 110mm Ø5 x 160mm Ø6 x 160mm Ø8 x 160mm Ø9 x 160mm Ø10 x 160mm Ø12 x 160mm, 1 portainseri, 1 scalpello piatto e 1 scalpello a punta.



P076-

SEGA A TAZZA PER EDILIZIA CON TAGLIANTI IN METALLO DURO

Per l'esecuzione di fori di medie e grandi dimensioni nel muro

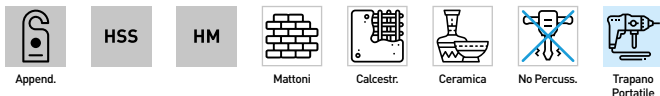

Art.	€	Ø	d	Filetto	Z	L	Punta
P076/016	€ 14,40	16 mm	10 mm	M12 x 1.25	2	46 mm	Ø6 x 69 mm
P076/022	€ 15,40	22 mm	10 mm	M12 x 1.25	3	46 mm	Ø6 x 69 mm
P076/025	€ 19,50	25 mm	10 mm	M12 x 1.25	3	46 mm	Ø6 x 69 mm
P076/027	€ 20,60	27 mm	10 mm	M12 x 1.25	4	46 mm	Ø6 x 69 mm
P076/030	€ 21,60	30 mm	10 mm	M12 x 1.25	4	46 mm	Ø6 x 69 mm
P076/035	€ 22,10	35 mm	10 mm	M12 x 1.25	4	46 mm	Ø6 x 69 mm
P076/038	€ 24,60	38 mm	10 mm	M12 x 1.25	4	46 mm	Ø6 x 69 mm
P076/040	€ 27,20	40 mm	10 mm	M12 x 1.25	5	46 mm	Ø6 x 69 mm
P076/045	€ 29,30	45 mm	10 mm	M12 x 1.25	5	46 mm	Ø6 x 69 mm
P076/050	€ 30,80	50 mm	10 mm	M12 x 1.25	6	46 mm	Ø6 x 69 mm
P076/055	€ 34,90	55 mm	12 mm	M16 x 1.5	6	46 mm	Ø8 x 69 mm
P076/060	€ 37,00	60 mm	12 mm	M16 x 1.5	7	46 mm	Ø8 x 69 mm
P076/065	€ 41,00	65 mm	12 mm	M16 x 1.5	7	46 mm	Ø8 x 69 mm
P076/070	€ 51,40	70 mm	12 mm	M16 x 1.5	8	46 mm	Ø8 x 69 mm
P076/080	€ 58,50	80 mm	12 mm	M16 x 1.5	8	46 mm	Ø8 x 69 mm
P076/085	€ 66,30	85 mm	12 mm	M16 x 1.5	9	46 mm	Ø8 x 69 mm
P076/090	€ 77,00	90 mm	12 mm	M16 x 1.5	9	46 mm	Ø8 x 69 mm
P076/095	€ 78,00	95 mm	12 mm	M16 x 1.5	10	46 mm	Ø8 x 69 mm
P076/100	€ 83,70	100 mm	12 mm	M16 x 1.5	11	46 mm	Ø8 x 69 mm
P076/110	€ 98,60	110 mm	12 mm	M16 x 1.5	11	46 mm	Ø8 x 69 mm
P076/125	€ 109,00	125 mm	12 mm	M16 x 1.5	12	46 mm	Ø8 x 69 mm
P076/150	€ 139,00	150 mm	12 mm	M16 x 1.5	15	46 mm	Ø8 x 69 mm

P076-GX400

GAMBO LUNGO PER SEGHE A TAZZA PER EDILIZIA

Per articolo P076-



Art.	€	d	L	Filetto	Misure
P076/G12400	€ 20,60	10 mm	400 mm	M12 x 1.25	16-50
P076/G16400	€ 30,30	12 mm	400 mm	M16 x 1.5	55-150

P076/006S

€ 138,00

SERIE DI SEGHE A TAZZA PER EDILIZIA

Per l'esecuzione di fori di medie e grandi dimensioni nel muro



Misure 16 mm - 22 mm - 25 mm - 27 mm - 30 mm - 35 mm

P076/008S

€ 203,00

SERIE DI SEGHE A TAZZA PER EDILIZIA

Per l'esecuzione di fori di medie e grandi dimensioni nel muro



Misure 16 mm - 22 mm - 25 mm - 27 mm - 30 mm - 35 mm - 40 mm - 45 mm

P076-GX

GAMBO PER SEGHE A TAZZA PER EDILIZIA

Per articolo P076-



Art.	€	d	L	Filetto	Misure
P076/G12	€ 3,60	10 mm	46 mm	M12 x 1.25	16-50
P076/G16	€ 4,82	12 mm	46 mm	M16 x 1.5	55-150

P076-PX

PUNTA PILOTA PER SEGHE A TAZZA PER EDILIZIA

Per articolo P076-



Art.	€	Ø	Lunghezza totale	Misure	Pack
P076/P12	€ 1,54	6 mm	69 mm	16-50	10
P076/P16	€ 2,06	8 mm	69 mm	55-150	10



P031-

PUNTE A TAZZA DIAMANTATE A CORONA CONTINUA

La corona diamantata a spessore sottile garantisce tagli senza sbavature. Questa caratteristica agevola i lavori di foratura su piastrelle dure in posa, dove sia necessario realizzare un foro pulito, senza scheggiare la piastrella. Invertendo periodicamente il senso di rotazione della fresa da orario ad antiorario si ravvivano i diamanti e la fresa continua a lavorare per un ciclo di vita utile più lungo



Art.	€	Misura	Attacco esagonale	Lunghezza totale	Altezza diamante	Grana
P031/05	€ 15,40	Ø 5 mm	8.5 mm	56 mm	2 mm	50/60
P031/06	€ 15,90	Ø 6 mm	8.5 mm	56 mm	2 mm	50/60
P031/07	€ 17,00	Ø 7 mm	8.5 mm	56 mm	2 mm	50/60
P031/08	€ 18,00	Ø 8 mm	8.5 mm	56 mm	2 mm	50/60
P031/10	€ 20,60	Ø 10 mm	8.5 mm	56 mm	2 mm	50/60
P031/12	€ 21,60	Ø 12 mm	8.5 mm	56 mm	2 mm	50/60
P031/14	€ 24,60	Ø 14 mm	8.5 mm	56 mm	2 mm	50/60
P031/16	€ 29,80	Ø 16 mm	11 mm	90 mm	5 mm	35/40
P031/18	€ 30,80	Ø 18 mm	11 mm	90 mm	5 mm	35/40
P031/20	€ 34,90	Ø 20 mm	11 mm	90 mm	5 mm	35/40
P031/22	€ 38,00	Ø 22 mm	11 mm	90 mm	5 mm	35/40
P031/25	€ 43,10	Ø 25 mm	11 mm	90 mm	5 mm	35/40
P031/28	€ 46,20	Ø 28 mm	11 mm	90 mm	5 mm	35/40
P031/30	€ 51,40	Ø 30 mm	11 mm	90 mm	5 mm	35/40
P031/32	€ 55,40	Ø 32 mm	11 mm	90 mm	5 mm	35/40
P031/35	€ 59,50	Ø 35 mm	11 mm	90 mm	5 mm	35/40
P031/40	€ 67,80	Ø 40 mm	11 mm	90 mm	5 mm	35/40
P031/45	€ 76,00	Ø 45 mm	11 mm	90 mm	5 mm	35/40
P031/50	€ 85,30	Ø 50 mm	11 mm	90 mm	5 mm	35/40
P031/60	€ 106,00	Ø 60 mm	11 mm	90 mm	5 mm	35/40
P031/65	€ 115,00	Ø 65 mm	11 mm	90 mm	5 mm	35/40
P031/67	€ 124,00	Ø 67 mm	11 mm	90 mm	5 mm	35/40
P031/70	€ 136,00	Ø 70 mm	11 mm	90 mm	5 mm	35/40
P031/80	€ 156,00	Ø 80 mm	11 mm	90 mm	5 mm	35/40

P031/06P

€ 2,82

PUNTA PILOTA

Per articolo P031-XI



Diametro	Ø 6 mm
Lunghezza	100 mm
Gambo	Ø 5 mm
Pack	10

P031/03S

€ 51,40

SERIE PUNTE E TAZZE DIAMANTATE A CORONA CONTINUA

La corona diamantata a spessore sottile garantisce tagli senza sbavature. Questa caratteristica agevola i lavori di foratura su piastrelle dure in posa, dove sia necessario realizzare un foro pulito, senza scheggiare la piastrella. Invertendo periodicamente il senso di rotazione della fresa da orario ad antiorario si ravvivano i diamanti e la fresa continua a lavorare per un ciclo di vita utile più lungo



Misure	Ø 6 mm - 8 mm - 10 mm
Attacco esagonale	9.5 mm
Lunghezza totale	56 mm
Altezza diamante	2 mm
Grana	50/60

P031/05S

€ 82,20

SERIE PUNTE E TAZZE DIAMANTATE A CORONA CONTINUA

La corona diamantata a spessore sottile garantisce tagli senza sbavature. Questa caratteristica agevola i lavori di foratura su piastrelle dure in posa, dove sia necessario realizzare un foro pulito, senza scheggiare la piastrella. Invertendo periodicamente il senso di rotazione della fresa da orario ad antiorario si ravvivano i diamanti e la fresa continua a lavorare per un ciclo di vita utile più lungo



Misure	Ø 5 mm - 6 mm - 8 mm - 10 mm - 12 mm
Attacco esagonale	8.5 mm
Lunghezza totale	56 mm
Altezza diamante	2 mm
Grana	50/60

P031/06S

€ 246,00

SERIE PUNTE E TAZZE DIAMANTATE A CORONA CONTINUA

La corona diamantata a spessore sottile garantisce tagli senza sbavature. Questa caratteristica agevola i lavori di foratura su piastrelle dure in posa, dove sia necessario realizzare un foro pulito, senza scheggiare la piastrella. Invertendo periodicamente il senso di rotazione della fresa da orario ad antiorario si ravvivano i diamanti e la fresa continua a lavorare per un ciclo di vita utile più lungo



Misure	Ø 16 mm - 22 mm - 25 mm - 28 mm - 30 mm - 35 mm
Attacco esagonale	11 mm
Lunghezza totale	90 mm
Altezza diamante	5 mm
Grana	50/60



P033-

PUNTE DIAMANTATE A CORONA CONTINUA

Funzionamento ottimale su pareti verticali, non asportare la carota, che funge da tappo-dosatore per il refrigerante. L'utilizzo con refrigerazione ad acqua allunga la vita utile dell'utensile. La corona diamantata a spessore sottile garantisce tagli senza sbavature. Questa caratteristica agevola i lavori di foratura su piastrelle dure in posa, dove sia necessario realizzare un foro pulito

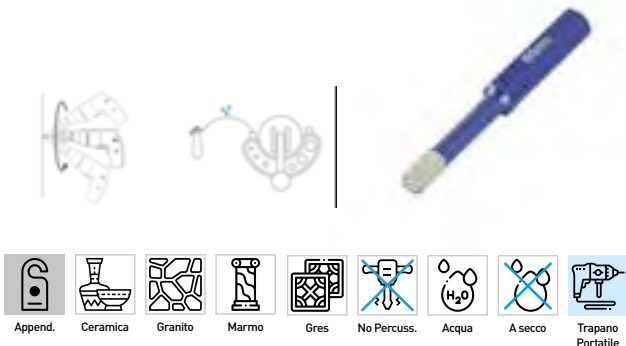

Art.	€	Misura	Attacco esagonale	Lunghezza totale	Altezza diamante	Grana
P033/05	€ 25,60	Ø 5 mm	9.5 mm	80 mm	10 mm	40
P033/06	€ 25,60	Ø 6 mm	9.5 mm	80 mm	10 mm	40
P033/08	€ 25,60	Ø 8 mm	9.5 mm	80 mm	10 mm	40
P033/10	€ 27,70	Ø 10 mm	9.5 mm	80 mm	10 mm	40
P033/12	€ 30,80	Ø 12 mm	9.5 mm	80 mm	10 mm	40
P033/14	€ 32,90	Ø 14 mm	12.5 mm	80 mm	10 mm	40
P033/16	€ 38,00	Ø 16 mm	12.5 mm	80 mm	10 mm	40
P033/18	€ 43,10	Ø 18 mm	12.5 mm	80 mm	10 mm	40
P033/20	€ 48,30	Ø 20 mm	12.5 mm	80 mm	10 mm	40
P033/22	€ 52,40	Ø 22 mm	12.5 mm	80 mm	10 mm	40
P033/25	€ 59,50	Ø 25 mm	12.5 mm	80 mm	10 mm	40

P034-

PUNTE E TAZZE DIAMANTATE M14 A CORONA CONTINUA

La corona diamantata a spessore sottile garantisce tagli senza sbavature. Questa caratteristica agevola i lavori di foratura su piastrelle dure in posa, dove sia necessario realizzare un foro pulito, senza scheggiare la piastrella. Invertendo periodicamente il senso di rotazione della fresa da orario ad antiorario si ravvivano i diamanti e la fresa continua a lavorare per un ciclo di vita utile più lungo



Art.	€	Misura	Lunghezza totale	Altezza diamante	Grana
P034/006	€ 30,30	Ø 6 mm	62 mm	10 mm	30/50
P034/008	€ 30,80	Ø 8 mm	62 mm	10 mm	30/50
P034/010	€ 30,80	Ø 10 mm	62 mm	10 mm	30/50
P034/012	€ 32,90	Ø 12 mm	62 mm	10 mm	30/50
P034/014	€ 36,00	Ø 14 mm	62 mm	10 mm	30/50
P034/016	€ 36,50	Ø 16 mm	62 mm	15 mm	30/50
P034/018	€ 37,00	Ø 18 mm	62 mm	15 mm	30/50
P034/020	€ 37,50	Ø 20 mm	60 mm	15 mm	30/50
P034/022	€ 38,00	Ø 22 mm	60 mm	15 mm	30/50
P034/025	€ 38,60	Ø 25 mm	60 mm	15 mm	30/50
P034/028	€ 42,10	Ø 28 mm	60 mm	15 mm	30/50
P034/030	€ 45,20	Ø 30 mm	60 mm	15 mm	30/50
P034/032	€ 48,30	Ø 32 mm	60 mm	15 mm	30/50
P034/035	€ 52,40	Ø 35 mm	60 mm	15 mm	30/50
P034/040	€ 60,60	Ø 40 mm	60 mm	15 mm	30/50
P034/045	€ 67,80	Ø 45 mm	60 mm	15 mm	30/50
P034/050	€ 72,90	Ø 50 mm	60 mm	15 mm	30/50
P034/055	€ 82,20	Ø 55 mm	60 mm	15 mm	30/50
P034/060	€ 90,30	Ø 60 mm	60 mm	15 mm	30/50
P034/065	€ 97,60	Ø 65 mm	60 mm	15 mm	30/50
P034/067	€ 101,00	Ø 67 mm	60 mm	15 mm	30/50
P034/070	€ 106,00	Ø 70 mm	60 mm	15 mm	30/50
P034/080	€ 120,00	Ø 80 mm	60 mm	15 mm	30/50
P034/090	€ 132,00	Ø 90 mm	60 mm	15 mm	30/50
P034/100	€ 163,00	Ø 100 mm	60 mm	15 mm	30/50

P033/03S

€ 71,80

SERIE PUNTE E TAZZE DIAMANTATE A CORONA CONTINUA

Funzionamento ottimale su pareti verticali, non asportare la carota, che funge da tappo-dosatore per il refrigerante. L'utilizzo con refrigerazione ad acqua allunga la vita utile dell'utensile. La corona diamantata a spessore sottile garantisce tagli senza sbavature. Questa caratteristica agevola i lavori di foratura su piastrelle dure in posa, dove sia necessario realizzare un foro pulito

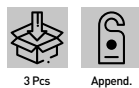

Misure	Ø 6 mm - 8 mm - 10 mm
Attacco esagonale	9.5 mm
Lunghezza totale	80 mm
Altezza diamante	10 mm
Grana	40

P034/05S

€ 154,00

SERIE PUNTE E TAZZE DIAMANTATE M14 A CORONA CONTINUA

La corona diamantata a spessore sottile garantisce tagli senza sbavature. Questa caratteristica agevola i lavori di foratura su piastrelle dure in posa, dove sia necessario realizzare un foro pulito, senza scheggiare la piastrella. Invertendo periodicamente il senso di rotazione della fresa da orario ad antiorario si ravvivano i diamanti e la fresa continua a lavorare per un ciclo di vita utile più lungo



Misure	Ø 6 mm - 8 mm - 10 mm - 12 mm - 14 mm
Lunghezza totale	62 mm
Altezza diamante	10 mm
Grana	30/50

P034/06S

€ 383,00

SERIE PUNTE E TAZZE DIAMANTATE M14 A CORONA CONTINUA

La corona diamantata a spessore sottile garantisce tagli senza sbavature. Questa caratteristica agevola i lavori di foratura su piastrelle dure in posa, dove sia necessario realizzare un foro pulito, senza scheggiare la piastrella invertendo periodicamente il senso di rotazione della fresa da orario ad antiorario si ravvivano i diamanti e la fresa continua a lavorare per un ciclo di vita utile più lungo.



Misure	Ø 22 mm - 35 mm - 40 mm - 45 mm - 50 mm - 67 mm
Lunghezza totale	60 mm
Altezza diamante	15 mm
Grana	30/50



P035-

PUNTE DIAMANTATE A CORONA CONTINUA

La corona diamantata a spessore sottile garantisce tagli senza sbavature. Questa caratteristica agevola i lavori di foratura su piastrelle dure in posa, dove sia necessario realizzare un foro pulito, senza scheggiare la piastrella. Invertendo periodicamente il senso di rotazione della fresa da orario ad antiorario si ravvivano i diamanti e la fresa continua a lavorare per un ciclo di vita utile più lungo

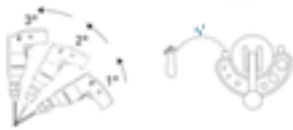

Art.	€	Misura	Gambo	Lunghezza totale	Altezza diamante	Grana
P035/05	€ 8,30	Ø 5 mm	Ø 6 mm	65 mm	5 mm	60/80
P035/06	€ 8,30	Ø 6 mm	Ø 6 mm	65 mm	5 mm	60/80
P035/08	€ 8,30	Ø 8 mm	Ø 6 mm	65 mm	5 mm	60/80
P035/10	€ 8,30	Ø 10 mm	Ø 6 mm	65 mm	5 mm	60/80
P035/12	€ 9,20	Ø 12 mm	Ø 6 mm	65 mm	5 mm	60/80
P035/14	€ 10,20	Ø 14 mm	Ø 6 mm	65 mm	5 mm	60/80

D009/5-12

€ 28,70

DIMA A VENTOSA CON FORI DI GUIDA

Consente un'agevole centratura e sicurezza di taglio della punta diamantata nei vari materiali lavorabili. Da utilizzare in accoppiata con nebulizzatore per lavorazioni ad acqua



Fori 4 mm - 5 mm - 6 mm - 7 mm - 8 mm - 10 mm - 12 mm

P035/04S

€ 30,80

SERIE PUNTE DIAMANTATE A CORONA CONTINUA

La corona diamantata a spessore sottile garantisce tagli senza sbavature. Questa caratteristica agevola i lavori di foratura su piastrelle dure in posa, dove sia necessario realizzare un foro pulito, senza scheggiare la piastrella. Invertendo periodicamente il senso di rotazione della fresa da orario ad antiorario si ravvivano i diamanti e la fresa continua a lavorare per un ciclo di vita utile più lungo



Misure	Ø 5 mm - 6 mm - 8 mm - 10 mm
Gambo	Ø 6 mm
Lunghezza totale	65 mm
Altezza diamante	5 mm
Grana	60/80

0529

€ 39,10

SERIE PUNTE DIAMANTATE

La corona diamantata a spessore sottile garantisce tagli senza sbavature. Questa caratteristica agevola i lavori di foratura su piastrelle dure in posa, dove sia necessario realizzare un foro pulito, senza scheggiare la piastrella. Invertendo periodicamente il senso di rotazione della fresa da orario ad antiorario si ravvivano i diamanti e la fresa continua a lavorare per un ciclo di vita utile più lungo.



Punte	Ø 5 - 6 - 8 - 10 - 12 mm
Lunghezza totale	60 mm
Taglio utile	30 mm
Altezza diamante	3 mm
Grana	70/80

D009/5-85

€ 43,10

DIMA REGOLABILE A VENTOSA

Consente un'agevole centratura e sicurezza di taglio della punta diamantata nei vari materiali lavorabili. Da utilizzare in accoppiata con nebulizzatore per lavorazioni ad acqua



Fori 5 - 85 mm

D020

€ 26,30

SERIE FRESE ROTATIVE DIAMANTATE

Adatte per incisioni, scritte o rifiniture grazie alle varie geometrie disponibili



Gambo Ø 3 mm
Lunghezza 45 mm

D050

€ 51,60

SERIE FRESE ROTATIVE DIAMANTATE

Adatte per incisioni, scritte o rifiniture grazie alle varie geometrie disponibili

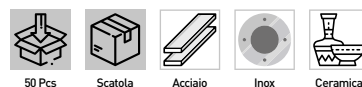

Gambo Ø 3 mm
Lunghezza 45 mm

P052-

PUNTE ELICOIDALI PER LEGNO

DIN 7487, a doppia elica, con punta di centraggio consente un posizionamento esatto del foro



Art.	€	Ø	Lunghezza totale	Lunghezza elica	Pack
P052/03	€ 0,88	3 mm	61 mm	33 mm	5
P052/04	€ 0,97	4 mm	75 mm	43 mm	5
P052/05	€ 1,17	5 mm	86 mm	52 mm	5
P052/06	€ 1,27	6 mm	93 mm	57 mm	5
P052/07	€ 1,56	7 mm	109 mm	69 mm	5
P052/08	€ 2,05	8 mm	117 mm	75 mm	5
P052/09	€ 2,34	9 mm	125 mm	81 mm	1
P052/10	€ 2,74	10 mm	133 mm	87 mm	1
P052/11	€ 3,61	11 mm	142 mm	94 mm	1
P052/12	€ 4,49	12 mm	151 mm	101 mm	1
P052/13	€ 5,20	13 mm	151 mm	101 mm	1
P052/14	€ 6,40	14 mm	160 mm	108 mm	1
P052/15	€ 7,60	15 mm	169 mm	114 mm	1
P052/16	€ 10,60	16 mm	178 mm	120 mm	1
P052/17	€ 12,20	17 mm	184 mm	125 mm	1
P052/18	€ 14,20	18 mm	191 mm	130 mm	1
P052/19	€ 16,10	19 mm	198 mm	135 mm	1
P052/20	€ 17,60	20 mm	205 mm	140 mm	1

P052/08S

€ 13,60

SERIE DI PUNTE ELICOIDALI PER LEGNO

DIN 7487, a doppia elica, con punta di centraggio consente un posizionamento esatto del foro



Misura 3 ÷ 10 mm

0238

€ 12,10

SERIE SEGHE A TAZZA PER LEGNO



Misure Ø 22 - 29 - 32 - 38 - 44 - 51 - 57 - 67 mm

0463

€ 21,80

SERIE PUNTE CON SVASATORE PER LEGNO

Per svasare il legno.



Misure 2 - 2,5 - 3 - 3,5 mm



0799-

SERIE PUNTE PER MORTASA



Art.	€	Misure	Rotazione	Gambo
0799/SXC	€ 68,00	Ø 6 - 8 - 10 - 12 - 14 - 16 mm	Sx	Ø 16 x 50 mm
0799/DXC	€ 68,00	Ø 6 - 8 - 10 - 12 - 14 - 16 mm	Dx	Ø 16 x 50 mm

0087

€ 43,90

SERIE PUNTE PER CERNIERE CON RIPIORTO IN METALLO DURO



Punte Ø 15 - 20 - 26 - 30 - 35 mm



0087/35

€ 11,10

PUNTA PER CERNIERE CON RIPIORTO IN METALLO DURO



Punta Ø 35 mm
Gambo Ø 10 mm





0526 € 31,20

SERIE PUNTE CON SVASATORE PER LEGNO

Attacco da 1/4" e svasatore per legno, per forare e svasare il legno senza rovinarlo

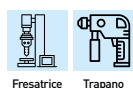
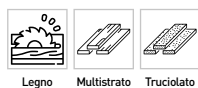

Punte 2,75 - 3,25 - 3,5 mm
Attacco 1/4"

0524 € 50,80

SERIE PORTA PUNTE CON ATTACCO 1/4"

Per velocizzare il lavoro sostituendo velocemente le punte



Misure 3-3.5-4-4.5-5-5.5-6-6.5-8-10 mm
Attacco 1/4"

0835/15 € 53,60

SERIE FRESE PER LEGNO

Per la lavorazione professionale del legno quali bordi, rifiniture, scanalature



Gambo Ø 6 mm

0830 € 232,00

SERIE FRESE PER LEGNO

Per la lavorazione professionale del legno quali bordi, rifiniture, scanalature



Gambo Ø 6 mm

0718 € 269,00

SET A FRESARE PER TOUPIE

Per la creazione di profili di varie geometrie sul legno.



Corpo frese Ø 100 x 40h mm
Foro Ø 30 mm
Cottelli 26



M015S

€ 55,40

SERIE MASCHI E PUNTE

Con giramaschi



Maschi	M3 x 0,50 mm, M4 x 0,70 mm, M5 x 0,80 mm, M6 x 1,00 mm, M8 x 1,2
Punte	Ø2,5 mm, Ø3,3 mm, Ø4,2 mm, Ø5,0 mm, Ø6,8 mm, Ø8,5 mm, Ø10

M312/P

€ 60,60

SERIE MASCHI PER FORI PASSANTI GAMBO RINFORZATO

Con giramaschi.



Misura	M3 x 0,50 - M4 x 0,70 - M5 x 0,80 - M6 x 1 - M8 x 1,25 - M10 x 1,50 - M12 x 1,75
---------------	--

M312/C

€ 65,90

SERIE MASCHI PER FORI CIECHI 35° GAMBO RINFORZATO

Con giramaschi.



Misura	M3 x 0,50 - M4 x 0,70 - M5 x 0,80 - M6 x 1 - M8 x 1,25 - M10 x 1,50 - M12 x 1,75
---------------	--

M020

€ 30,60

SERIE MASCHI E FILIERE

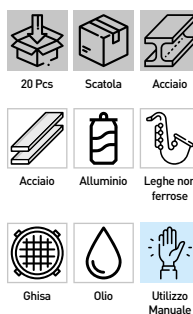

Giramaschio	M3 - M12
Girafiliera	25 x 9 mm
Maschi	M3x0,5 - M4x0,7 - M5x0,8 - M6x1 - M7x1 - M8x1,25 - M10x1,5 - M12x1,75 - 1/8" NPT27
Filiera	M3x0,5 - M4x0,7 - M5x0,8 - M6x1 - M7x1 - M8x1,25 - M10x1,5 - M12x1,75 - 1/8" NPT27

M036

€ 59,40

SERIE MASCHI E FILIERE

Con punte e contafiletti



Giramaschio	M3 - M12
Girafiliera	25 x 9 mm
Maschi	M3x0,5 - M4x0,7 - M5x0,8 - M6x1 - M7x1 - M8x1,25 - M10x1,5 - M12
Filiera	M3x0,5 - M4x0,7 - M5x0,8 - M6x1 - M7x1 - M8x1,25 - M10x1,5 - M12
Punte	2,5 - 3,3 - 4,2 - 5 - 6 - 6,8 - 8,5 - 10,3 mm
Giravite	6,5 x 50 mm

M032

€ 110,00

SERIE MASCHI E FILIERE

Con giramaschi, girafiliera e contafiletti.

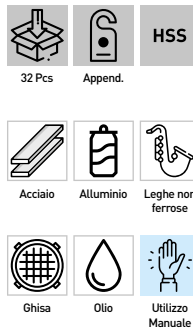

Maschi	M3x0,5 M4x0,7 M5x0,8 M6x1 M8x1,25 M10x1,5 M12x1,75
Filiera	M3x0,5 M4x0,7 M5x0,8 M6x1 M8x1,25 M10x1,5 M12x1,75
Giravite	3,5 x 50 mm



M029 € 118,00

SERIE MASCHI E FILIERE

Con punte, giramaschi e girafilieri a cricchetto

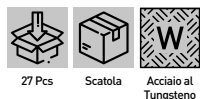

Manico a cricchetto	200 mm
Adattatore	Maschi 5 - 7,5 mm Filiere 25 x 9 mm
Maschi	M3x0,5 - M4x0,7 - M5x0,8 - M6x1 - M8x1,25 - M10x1,5 - M12x1,75
Filieri	M3x0,5 - M4x0,7 - M5x0,8 - M6x1 - M8x1,25 - M10x1,5 - M12x1,75
Punte	2,5 - 3,3 - 4,2 - 5 - 6,8 - 8,5 - 10,3 mm
Giravite	6,5 x 50 mm
Giravite	3 x 50 mm

M101 € 109,00

SERIE MASCHI E FILIERE

Maschio a mano e filiera: Metric M3x0,5 - UNC 1/4 20 - UNF 4 40 - Metric M4x0,7 - UNC 1/4 28 - UNF 6 32 - Metric M5x0,8 - UNC 5/16 18 - UNF 8 32 - Metric M6x1 - UNC 5/16 24 - UNF 10 32 - Metric M7x1 - UNC 3/8 16 - UNF 10 24 - Metric M8x1,25 - UNC 3/8 24 - UNF 12 24 - Metric M9x1,25 - UNC 7/16 14 - Metric M10x1,5 - UNC 7/16 20 - Metric M10x1 - UNC 1/2 13 - Metric M12x1,75 - UNC 1/2 20 - NPT 1/8 27. Completo di giramaschi e girafilieri.



M030 € 69,10

SERIE MASCHI E FILIERE

Da M1 a M2.5, con girafilieri e addattatori per convertirlo in giramaschi.



Misura M1 - M1.1 - M1.2 - M1.4 - M1.6 - M1.8 - M2.0 - M2.2 - M2.5

M100 € 146,00

SERIE MASCHI E FILIERE

Con giramaschi e girafilieri. M6x0,75 - M6x1 - M8x1 - M8x1,25 - M10x1,25 - M10x1,5 - M12x1,5 - M12x1,75 - M14x1,5 - M14x2 - M16x1,5 - M16x2 - M18x1,5 - M18x2,5 - M20x1,5 - M20x2,5 - M22x1,5 - M22x2,5 x M24x1,5 - M24x3



M218 € 235,00

SERIE MASCHI E FILIERE

Maschi a mano serie 2pz e filiera: M2 x 0,40 - M3 x 0,50 - M4 x 0,70 - M5 x 0,80 - M6 x 0,75 - M6 x 1 - M7 x 0,75 - M7 x 1 - M8 x 0,75 - M8 x 1 - M8 x 1,25 - M9 x 0,75 - M9 x 1 - M9 x 1,25 - M10 x 0,75 - M10 x 1 - M10 x 1,25 - M10 x 1,5 - M11 x 0,75 - M11 x 1 - M11 x 1,25 - M11 x 1,5 - M12 x 0,75 - M12 x 1 - M12 x 1,25 - M12 x 1,5 - M12 x 1,75 - M14 x 1 - M14 x 1,25 - M14 x 1,5 - M14 x 2 - M16 x 1 - M16 x 1,5 - M16 x 2 - M18 x 1,5. Completo di 2 giramaschi e 2 girafilieri.



MASCHIATURA

TIPOLOGIA DI SCALANATURE

SCALANATURE DRITTE IMBOCCO CORRETTO

La correzione dell'imbocco è data da una forte inclinazione dell'elica combinata a un accentuato angolo di taglio nella parte iniziale del maschio. Questa esecuzione assicura l'evacuazione dei trucioli in direzione dell'avanzamento. Pertanto nelle maschiate di fori passanti su materiali che producono truciolo continuo, sono pressochè eliminati i rischi di intasamento e rottura.



SCALANATURE ELICOIDALI A FORTE TORSIONE 35°

Le scalanature elicoidali inclinate favoriscono l'estrazione del truciolo in direzione opposta all'avanzamento del maschio. La forte inclinazione dell'elica inoltre assicura l'estrazione del truciolo da fori ciechi e profondi riducendo i rischi di intasamento e rottura.



SCelta DELLE VELOCITÀ DI TAGLIO TEORICHE DEI MASCHI A MACCHINA, IN FUNZIONE DEL MATERIALE DA FILETTARE



Materiale da lavorare	Velocità di taglio (m/min)	Refrigerante
Acciaio da costruzione basso legato R< 700÷900N/mm ²	10 - 20	Olio
Acciaio per utensili	4 - 8	Olio
Acciaio legato R<1100÷1300N/mm ²	2 - 5	Olio
Acciaio Inox	5 - 10	Olio
Ghisa Sferoidale	6 - 20	No lubrif.
Leghe di Rame	10 - 15	Olio
Ottone	20 - 30	Olio
Bronzo	6 - 15	Olio
Alluminio truciolo corto	15 - 30	Olio
Alluminio truciolo lungo	10 - 20	Olio
Titanio	3 - 4	Olio
Plastica e materiali termoplastici	5 - 15	Acqua
Materiali termoindurenti	5 - 10	No lubrif.



M001-X

MASCHI A MACCHINA PER FORI PASSANTI, IMBOCCO CORRETTO

DIN 371/B, filettatura metrica a passo grosso (MA) - gambo rinforzato.

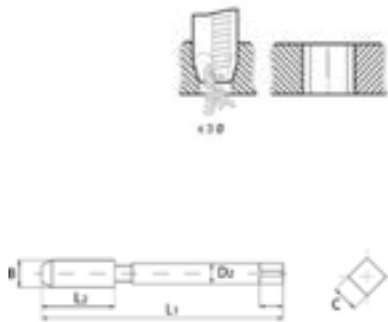

Art.	€	B	L2	L1	D2	C
M001/3	€ 5,80	M3 x 0,50	11 mm	56 mm	3.5 mm	2.7 mm
M001/4	€ 5,80	M4 x 0,70	13 mm	63 mm	4.5 mm	3.4 mm
M001/5	€ 7,10	M5 x 0,80	16 mm	70 mm	6 mm	4.9 mm
M001/6	€ 7,60	M6 x 1	19 mm	80 mm	6 mm	4.9 mm
M001/8	€ 9,30	M8 x 1,25	22 mm	90 mm	8 mm	6.2 mm
M001/10	€ 11,90	M10 x 1,5	24 mm	100 mm	10 mm	8 mm

M001-XV

MASCHI A MACCHINA PER FORI PASSANTI, IMBOCCO CORRETTO

DIN 371/B, filettatura metrica a passo grosso (MA) - gambo rinforzato, il trattamento di vaporizzazione aumenta la durezza superficiale e la resistenza a usura riducendo la possibilità d'incollamento dei trucioli.

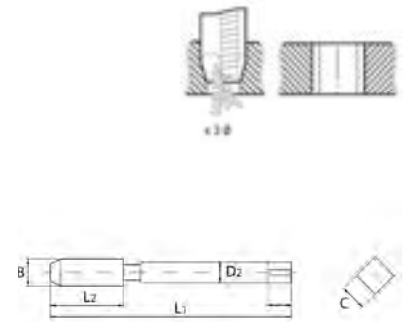
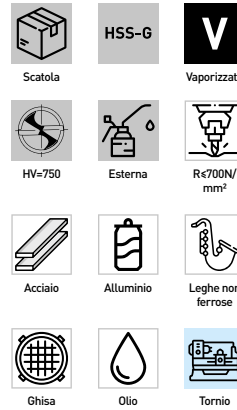

Art.	€	B	L2	L1	D2	C
M001/03V	€ 7,30	M3 x 0,50	11 mm	56 mm	3.5 mm	2.7 mm
M001/04V	€ 7,30	M4 x 0,70	13 mm	63 mm	4.5 mm	3.4 mm
M001/05V	€ 8,10	M5 x 0,80	16 mm	70 mm	6 mm	4.9 mm
M001/06V	€ 8,80	M6 x 1	19 mm	80 mm	6 mm	4.9 mm
M001/08V	€ 11,10	M8 x 1,25	22 mm	90 mm	8 mm	6.2 mm
M001/10V	€ 13,90	M10 x 1,5	24 mm	100 mm	10 mm	8 mm

M002-

MASCHI A MACCHINA PER FORI PASSANTI IMBOCCO CORRETTO

DIN 376/B, filettatura metrica a passo grosso (MA).

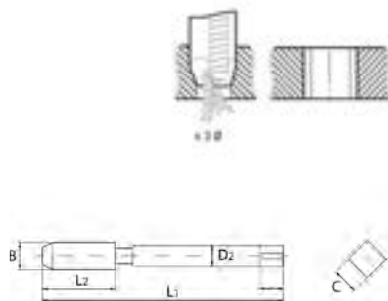

Art.	€	B	L2	L1	D2	C
M002/12	€ 12,90	M12 x 1,75	29 mm	110 mm	9 mm	7 mm
M002/14	€ 16,70	M14 x 2	30 mm	110 mm	11 mm	9 mm
M002/16	€ 18,60	M16 x 2	32 mm	110 mm	12 mm	9 mm
M002/18	€ 28,80	M18 x 2,5	34 mm	125 mm	14 mm	11 mm
M002/20	€ 34,20	M20 x 2,5	34 mm	140 mm	16 mm	12 mm
M002/22	€ 47,90	M22 x 2,5	34 mm	140 mm	18 mm	14.5 mm
M002/24	€ 52,60	M24 x 3	38 mm	160 mm	18 mm	14.5 mm
M002/27	€ 73,60	M27 x 3	38 mm	160 mm	20 mm	16 mm
M002/30	€ 85,30	M30 x 3,5	45 mm	180 mm	22 mm	18 mm

M002-XV

MASCHI A MACCHINA PER FORI PASSANTI IMBOCCO CORRETTO

DIN 376/B, filettatura metrica a passo grosso (MA) - gambo rinforzato, il trattamento di vaporizzazione aumenta la durezza superficiale e la resistenza a usura riducendo la possibilità d'incollamento dei trucioli.

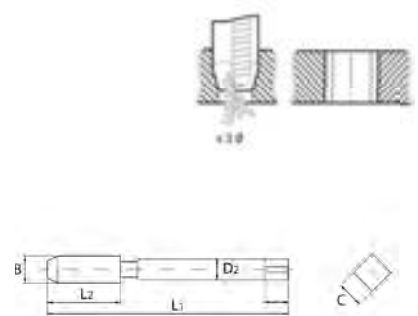

Art.	€	B	L2	L1	D2	C
M002/12V	€ 14,50	M12 x 1,75	29 mm	110 mm	9 mm	7 mm
M002/14V	€ 19,10	M14 x 2	30 mm	110 mm	11 mm	9 mm
M002/16V	€ 21,80	M16 x 2	32 mm	110 mm	12 mm	9 mm
M002/18V	€ 30,80	M18 x 2,5	34 mm	125 mm	14 mm	11 mm
M002/20V	€ 38,80	M20 x 2,5	34 mm	140 mm	16 mm	12 mm

M003-

MASCHI A MACCHINA PER FORI CIECHI A FORTE TORSIONE 35°

DIN 371/C, filettatura metrica a passo grosso (ma) - gambo rinforzato



Scatola
 HSS-G
 HV=750
 Esterna
 R<700N/mm²
 Acciaio
 Alluminio
 Leghe non ferrose
 Ghisa
 Olio
 Tornio
 Fresatrice

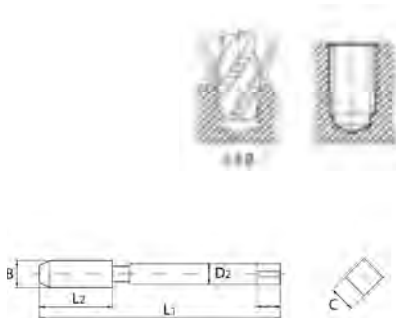

Art.	€	B	L2	L1	D2	C
M003/3	€ 5,80	M3 x 0,50	11 mm	56 mm	3.5 mm	2.7 mm
M003/4	€ 5,80	M4 x 0,70	13 mm	63 mm	4.5 mm	3.4 mm
M003/5	€ 6,50	M5 x 0,80	16 mm	70 mm	6 mm	4.9 mm
M003/6	€ 8,10	M6 x 1	19 mm	80 mm	6 mm	4.9 mm
M003/8	€ 9,90	M8 x 1,25	22 mm	90 mm	8 mm	6.2 mm
M003/10	€ 12,20	M10 x 1,5	24 mm	100 mm	10 mm	8 mm

M003-XV

MASCHI A MACCHINA PER FORI CIECHI A FORTE TORSIONE 35°

DIN 371/C, filettatura metrica a passo grosso (ma) - gambo rinforzato, il trattamento di vaporizzazione aumenta la durezza superficiale e la resistenza a usura riducendo la possibilità d'incollamento dei trucioli



Scatola
 HSS-G
 Vaporizzato
 HV=750
 Esterna
 R<700N/mm²
 Acciaio
 Alluminio
 Leghe non ferrose
 Ghisa
 Olio
 Tornio

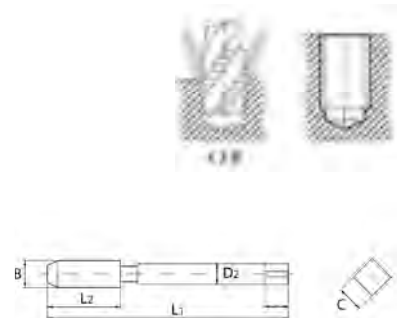

Art.	€	B	L2	L1	D2	C
M003/03V	€ 7,30	M3 x 0,50	11 mm	56 mm	3.5 mm	2.7 mm
M003/04V	€ 7,30	M4 x 0,70	13 mm	63 mm	4.5 mm	3.4 mm
M003/05V	€ 8,70	M5 x 0,80	16 mm	70 mm	6 mm	4.9 mm
M003/06V	€ 9,90	M6 x 1	19 mm	80 mm	6 mm	4.9 mm
M003/08V	€ 11,40	M8 x 1,25	22 mm	90 mm	8 mm	6.2 mm
M003/10V	€ 14,30	M10 x 1,5	24 mm	100 mm	10 mm	8 mm

M003-XXX

MASCHI A MACCHINA PER FORI CIECHI A FORTE TORSIONE 35°

DIN 376/C, filettatura metrica a passo grosso (ma)



Scatola
 HSS-G
 HV=750
 Esterna
 R<700N/mm²
 Acciaio
 Alluminio
 Leghe non ferrose
 Ghisa
 Olio
 Tornio
 Fresatrice

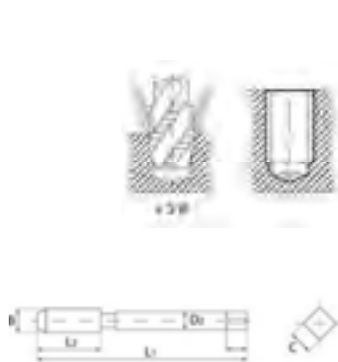

Art.	€	B	L2	L1	D2	C
M003/12	€ 13,30	M12 x 1,75	29 mm	110 mm	9 mm	7 mm
M003/14	€ 16,90	M14 x 2	30 mm	110 mm	11 mm	9 mm
M003/16	€ 19,40	M16x2	32 mm	110 mm	12 mm	9 mm
M003/18	€ 31,60	M18 x 2,5	34 mm	125 mm	14 mm	11 mm
M003/20	€ 34,70	M20 x 2,5	34 mm	140 mm	16 mm	12 mm
M003/22	€ 47,90	M22 x 2,5	34 mm	140 mm	18 mm	14.5 mm
M003/24	€ 52,50	M24 x 3	38 mm	160 mm	18 mm	14.5 mm
M003/27	€ 73,60	M27 x 3	38 mm	160 mm	20 mm	16 mm
M003/30	€ 85,30	M30 x 3,5	45 mm	180 mm	22 mm	18 mm

M003-XXV

MASCHI A MACCHINA PER FORI CIECHI A FORTE TORSIONE 35°

DIN 376/C, filettatura metrica a passo grosso (MA) - gambo rinforzato, il trattamento di vaporizzazione aumenta la durezza superficiale e la resistenza a usura riducendo la possibilità d'incollamento dei trucioli.



Scatola
 HSS-G
 Vaporizzato
 HV=750
 Esterna
 R<700N/mm²
 Acciaio
 Alluminio
 Leghe non ferrose
 Ghisa
 Olio
 Tornio

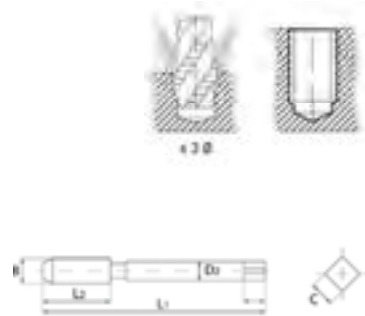

Art.	€	B	L2	L1	D2	C
M003/12V	€ 16,90	M12 x 1,75	29 mm	110 mm	9 mm	7 mm
M003/14V	€ 19,10	M14 x 2	30 mm	110 mm	11 mm	9 mm
M003/16V	€ 22,70	M16 x 2	32 mm	110 mm	12 mm	9 mm
M003/18V	€ 30,80	M18 x 2,5	34 mm	125 mm	14 mm	11 mm
M003/20V	€ 38,80	M20 x 2,5	34 mm	140 mm	16 mm	12 mm



0890-

UTENSILE 3 IN 1, PUNTA-MASCHIO-SVASATORE

Grazie alla particolare geometria in un'unica operazione è in grado di forare, filettare e svasare

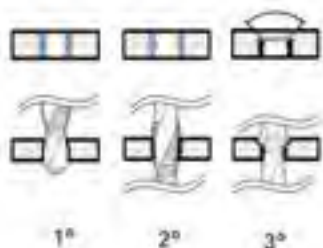

HSS



Scatola

Acciaio

Alluminio

Leghe non ferrose

Ghisa

Trapano Magnetico

Trapano Portatile

Art.	€	Maschi	Attacco	Dimensioni
0890/M3	€ 6,70	M3 x 0,5	1/4"	52 mm
0890/M4	€ 6,70	M4 x 0,7	1/4"	52 mm
0890/M5	€ 7,60	M5 x 0,8	1/4"	54 mm
0890/M6	€ 7,60	M6 x 1	1/4"	56 mm
0890/M8	€ 8,80	M8 x 1,25	1/4"	58 mm
0890/M10	€ 10,80	M10 x 1,5	1/4"	60 mm

G002-

GIRAMASCHI REGOLABILI

DIN 1814, con ganasce temprate, un'impugnatura svitabile per eseguire lavori con ingombri stretti



HSS-G

Blister

Art.	€	Maschi	Quadro
G002/1	€ 6,50	M1 ÷ M10	1,75 ÷ 5,5
G002/2	€ 9,60	M4 ÷ M12	2,4 ÷ 8 mm
G002/3	€ 13,30	M5 ÷ M20	2,7 ÷ 12

0890

€ 53,10

UTENSILI 3 IN 1, PUNTA-MASCHIO-SVASATORE E SERIE INSERTI

Grazie alla particolare geometria in un'unica operazione è in grado di forare, filettare e svasare. Con porta inserti a cambio rapido



14 Pcs



Scatola

HSS



Acciaio



Alluminio



Leghe non ferrose



Ghisa



Trapano Magnetico



Trapano Portatile

Maschi	M3 x 0,5 - M4 x 0,7 - M5 x 0,8 - M6 x 1 - M8 x 1,25 - M10 x 1,5
Attacco	1/4"
Phillips	1 - 2
Pozi-driv	1 - 2
Taglio	4 - 5 mm

G003-

GIRAMASCHI A CRICCHETTO

A funzionamento destrorso, sinistrorso o in posizione fissa



HSS-G

Blister

Art.	€	Maschi	Quadro
G003/1	€ 11,90	M3 ÷ M 8	1,75 ÷ 5,5
G003/2	€ 14,50	M5 ÷ M 12	4 ÷ 8



F123

NEW € 48,60

SERIE FILIERE

Da M3 a M12, completo di girafiliera



Misura M3 - M4 - M5 - M6 - M8 - M10 - M12
Girafiliera 25 x 9 mm

G001-

GIRAFILIERA

DIN 225, con 3 viti di fissaggio filiera, 1 impugnatura svitabile per eseguire lavori con ingombri stretti

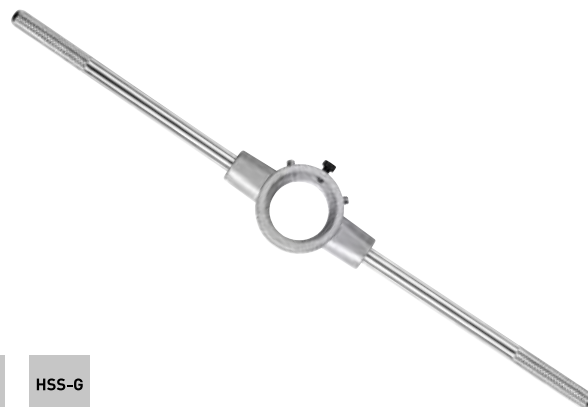

Art.	€	Dimensioni filiera	Per filiera
G001/20	€ 6,50	20 x 7 mm	M4,5 ÷ M6
G001/25	€ 6,50	25 x 9 mm	M7 ÷ M9
G001/30	€ 8,00	30 x 11 mm	M10 ÷ M11
G001/38	€ 12,20	38 x 14 mm	M12 ÷ M14
G001/45	€ 13,90	45 x 18 mm	M16 ÷ M20
G001/55	€ 15,00	55 x 22 mm	M22 ÷ M24

F121-

FILIERA METRICA PER FILETTATURA A PASSO GROSSO

DIN 223, con imbocco corretto su entrambi i lati per agevolare l'esecuzione del filetto ed evacuare correttamente i trucioli nella direzione di taglio



Art.	€	Passo	Dimensioni
F121/03	€ 8,00	3 x 0,5 mm	Ø20 x 5 mm
F121/04	€ 8,00	4 x 0,7 mm	Ø20 x 5 mm
F121/05	€ 9,10	5 x 0,8 mm	Ø20 x 7 mm
F121/06	€ 10,50	6 x 1 mm	Ø20 x 7 mm
F121/08	€ 10,50	8 x 1,25 mm	Ø25 x 9 mm
F121/10	€ 12,00	10 x 1,5 mm	Ø30 x 11 mm
F121/12	€ 13,90	12 x 1,75 mm	Ø38 x 14 mm
F121/14	€ 19,60	14 x 2 mm	Ø38 x 14 mm
F121/16	€ 23,00	16 x 2 mm	Ø45 x 18 mm
F121/18	€ 26,70	18 x 2,5 mm	Ø45 x 18 mm
F121/20	€ 28,30	20 x 2,5 mm	Ø45 x 18 mm

F122-

FILIERA PER FILETTATURA GAS CILINDRICA

DIN 5158/B, con imbocco corretto su entrambi i lati per agevolare l'esecuzione del filetto ed evacuare correttamente i trucioli nella direzione di taglio



Art.	€	Passo	Dimensioni
F122/1/8	€ 10,40	G1/8-28	Ø30 x 11 mm
F122/1/4	€ 18,10	G1/4-19	Ø38 x 10 mm
F122/3/8	€ 22,50	G3/8-19	Ø45 x 14 mm
F122/1/2	€ 24,20	G1/2-14	Ø45 x 14 mm
F122/5/8	€ 43,30	G5/8-14	Ø55 x 16 mm
F122/3/4	€ 47,50	G3/4-14	Ø55 x 16 mm
F122/7/8	€ 52,60	G7/8-14	Ø65 x 18 mm
F122/1	€ 53,10	G1-11	Ø65 x 18 mm

GAMMA RIPRISTINA FILETTI F-COIL

E' indispensabile per il rinforzo delle filettature in materiali con resistenza ridotta (alluminio, leghe di alluminio o di magnesio). I settori industriali dove trova maggior impiego sono: costruzioni meccaniche ed edilizia, industria automobilistica, attrezzature mediche ed elettroniche e costruzioni aerospaziali e aeronautiche. Il rinforzo della maschiatura elimina l'usura della maschiatura stessa, permettendo un utilizzo frequente del filetto stesso. Sono indispensabili per un ripristino economico e duraturo delle filettature usurate o scartate in fabbricazione.

PROCEDIMENTO DI RIPRISTINO E POSA

1° operazione Conoscere il tipo di filetto rovinato

Conoscenza del tipo di filetto rovinato in modo da poter acquistare il kit adeguato al ripristino.



2° operazione Esecuzione foratura con punta specifica

Esecuzione foratura per la rimozione del filetto rovinato e per la preparazione alla filettatura per il nuovo inserto-filetto F-Coil



3° Operazione Esecuzione maschiatura per preparazione alloggio Filetto F-Coil

Esecuzione dell'operazione di maschiatura con il maschio specifico per la realizzazione dell'alloggio per l'inserto filetto F-Coil.



4° Operazione Avvitare l'inserto Coil con apposito utensile

Avvitare l'inserto F-Coil con l'apposito utensile di montaggio fino a raggiungere la profondità necessaria. Nel caso un'elica non bastasse è possibile aggiungerne altre fino alla profondità necessaria. E' consigliata l'applicazione di colla frenafilletti per evitare il possibile smontaggio del F-Coil



5° Operazione Rottura con apposito troncatore della tacca di trascimento

Ultimata l'installazione dell'inserto-filetto procedere con la rottura del codolo di trascimento. Per poterlo rompere è necessario utilizzare l'utensile specifico per la rottura. A partire dalla dimensione del filetto di M14 è possibile eseguire questa operazione con l'utilizzo di una pinza laddove la dimensione del passo lo permette.



RIPARAZIONE FILETTI PER SEDI CANDELE

Per il ripristino delle sedi Candele danneggiate il procedimento è diverso: si effettua direttamente la filettatura con l'apposito maschio in dotazione al KIT sul filetto rovinato. Dopodichè viene inserita la boccola-filetto F-COIL che deve essere avvitata completamente fino alla battuta. E' consigliata l'applicazione di collante frenafilletti.

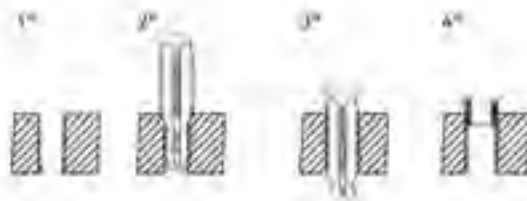

COMPOSIZIONE KIT RIPARAZIONE FILETTI

1	Inserti filettati in acciaio inox da inserire nella maschiatura eseguita ricreando il filetto precedentemente rovinato (disponibile nelle lunghezze di 1xØ, 1,5xØ, 2xØ, 2,5xØ e 3xØ).		
2	Punta elicoidale in HSS per la realizzazione del preforo per maschio		
3	Maschio specifico per l'esecuzione della maschiatura per l'applicazione dell'inserto filettato		
4	Utensile per montaggio inserti filettati F-Coil	Per inserti filetti fino a M24	
		Per inserti da M26	
5	Utensile specifico per la rottura del codolo F-Coil		





E010

€ 123,00

KIT RIPARAZIONE FILETTI METRICI F-COIL

Adatti per la rigenerazione delle filettature o per ottenere delle maschiature molto resistenti in materiali teneri

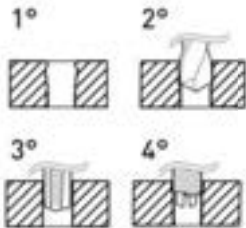

Misure	M5 - M12
Maschi STI	M5 x 0.8 - M6 x 1.0 - M8 x 1.25 - M10 x 1.5 - M12 x 1.75
Punte	5.2 mm - 6.3 mm - 8.3 mm - 10.4 mm - 12.4 mm
Inseri filettati	M5=25 M6=25 M8=25 M10=25 M12=10
Utensile montaggio	5 Pz
Attrezzo rottura	5 Pz

E010E

€ 107,00

KIT RIPARAZIONE FILETTI METRICI F-COIL

Adatti per la rigenerazione delle filettature o per ottenere delle maschiature molto resistenti in materiali teneri

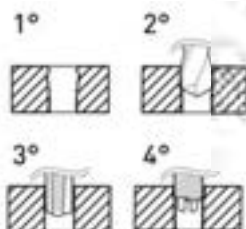

Misure	M5 - M12
Maschi STI	M5 x 0.8 - M6 x 1.0 - M8 x 1.25 - M10 x 1.5 - M12 x 1.75
Punte	5.2 mm - 6.3 mm - 8.3 mm - 10.4 mm - 12.4 mm
Inseri filettati	M5=25 M6=25 M8=25 M10=25 M12=10
Utensile montaggio	5 Pz
Attrezzo rottura	5 Pz

E010B

€ 159,00

KIT RIPARAZIONE FILETTI METRICI F-COIL

Adatti per la rigenerazione delle filettature o per ottenere delle maschiature molto resistenti in materiali teneri

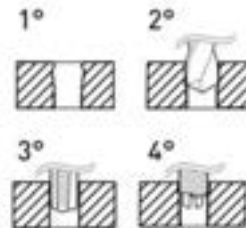

Misure	M6 - M14
Maschi STI	M6 x 1.0 - M8 x 1.25 - M10 x 1.5 - M12 x 1.75 - M14 x 1.25
Punte	6.3 mm - 8.3 mm - 10.4 mm - 12.4 mm
Inseri filettati	M6=25 M8=25 M10=20 M12=15 M14=25
Utensile montaggio	5 Pz
Attrezzo rottura	5 Pz

E010-

KIT RIPARAZIONE FILETTI

Adatti per la rigenerazione delle filettature o per ottenere delle maschiature molto resistenti in materiali teneri

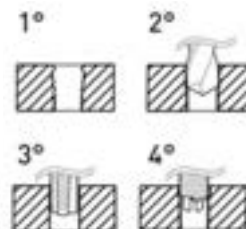

Art.	€	Filetto inserito	Punta	Maschi	Manico
E010/M05	€ 27,10	M5	5,2 mm	x M5	2
E010/M06	€ 29,40	M6	6,3 mm	x M6	2
E010/M08	€ 32,40	M8	8,3 mm	x M8	2
E010/M10	€ 39,10	M10	10,4 mm	x M10	2
E010/M12	€ 41,40	M12	12,4 mm	x M12	2
E010/M14	€ 49,50	M14 x 1,25	14,4 mm	x M14 x 1,25	2

E011A € 164,00

KIT RIPARAZIONE FILETTI METRICI F-COIL

Adatti per la rigenerazione delle filettature o per ottenere delle maschiature molto resistenti in materiali teneri





HSS
INOX
 130 Pcs Valigetta

Misure	M5 - M12
Maschi STI	M5 x 0.8 - M6 x 1.0 - M8 x 1.25 - M10 x 1.5 - M12 x 1.75
Punte	5.2 mm - 6.3 mm - 8.3 mm - 10.4 mm
Inseriti filettati	M5=25 M6=25 M8=25 M10=25 M12=10
Utensile montaggio	5 Pz
Attrezzo rottura	5 Pz

E011B € 192,00

KIT RIPARAZIONE FILETTI METRICI F-COIL

Adatti per la rigenerazione delle filettature o per ottenere delle maschiature molto resistenti in materiali teneri





HSS
INOX
 113 Pcs Valigetta

Misure	M6 - M14
Maschi STI	M6 x 1.0 - M8 x 1.25 - M10 x 1.5 - M12 x 1.75 - M14 x 1.25
Punte	6.3 mm - 8.3 mm - 10.4 mm - 12.4 mm
Inseriti filettati	M6=25 M8=25 M10=25 M12=10 M14=10
Utensile montaggio	5 Pz
Attrezzo rottura	4 Pz

E011C € 113,00

KIT RIPARAZIONE FILETTI METRICI F-COIL

Adatti per la rigenerazione delle filettature o per ottenere delle maschiature molto resistenti in materiali teneri





HSS
INOX
 87 Pcs Append.

Misure	M6 - M10
Maschi STI	M6 x 1.0 - M8 x 1.25 - M10 x 1.5
Punte	6.3 mm - 8.3 mm - 10.4 mm
Inseriti filettati	M6 25 Pz - M8 25 Pz - M10 25 Pz
Utensile montaggio	3 Pz
Attrezzo rottura	3 Pz

E011D € 203,00

KIT RIPARAZIONE FILETTI METRICI F-COIL

Adatti per la rigenerazione delle filettature o per ottenere delle maschiature molto resistenti in materiali teneri. Misura da 14mm specifica per candele auto





HSS
INOX
 113 Pcs Valigetta

Misure	M6 - M14
Maschi STI	M6 x 1.0 - M8 x 1.25 - M10 x 1.5 - M12 x 1.75 - M14 x 1.25
Punte	6.3 mm - 8.3 mm - 10.4 mm - 12.4 mm
Inseriti filettati	M6 25 Pz - M8 25 Pz - M10 25 Pz - M12 10 Pz - M14 10 Pz
Utensile montaggio	5 Pz
Attrezzo rottura	4 Pz



E011-MX1

KIT RIPARAZIONE FILETTI METRICI F-COIL

Adatti per la rigenerazione delle filettature o per ottenere delle maschiature molto resistenti in materiali teneri

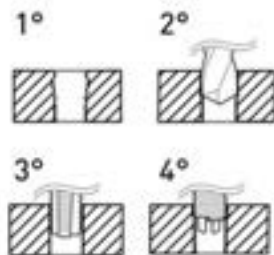

Append.

Art.	€	Dimensioni	Punta	Maschi STI	Utensile montaggio	Attrezzo rottura	Quantità inserti
E011/M020X040	€ 26,20	M 2 x 0.4	Ø 2.1 mm	E011/M020X040M	E011/U02	E011/A02	20
E011/M025X045	€ 26,20	M 2.5 x 0.45	Ø 2.6 mm	E011/M025X045M	E011/U03	E011/A03	20
E011/M030X050	€ 26,20	M 3 x 0.5	Ø 3.2 mm	E011/M030X050M	E011/U04	E011/A04	20
E011/M035X060	€ 26,20	M 3.5 x 0.6	Ø 3.7 mm	E011/M035X060M	E011/U05	E011/A05	20
E011/M040X070	€ 26,20	M 4 x 0.7	Ø 4.2 mm	E011/M040X070M	E011/U06	E011/A06	20
E011/M050X080	€ 27,10	M 5 x 0.8	Ø 5.2 mm	E011/M050X080M	E011/U08	E011/A08	20
E011/M060X100	€ 28,80	M 6 x 1.0	Ø 6.3 mm	E011/M060X100M	E011/U09	E011/A09	20
E011/M070X100	€ 35,70	M 7 x 1.0	Ø 7.3 mm	E011/M070X100M	E011/U10	E011/A11	20
E011/M080X100	€ 35,70	M 8 x 1.0	Ø 8.3 mm	E011/M080X100M	E011/U11	E011/A11	20
E011/M080X125	€ 35,70	M 8 x 1.25	Ø 8.3 mm	E011/M080X125M	E011/U11	E011/A11	20
E011/M090X100	€ 35,70	M 9 x 1.0	Ø 9.3 mm	E011/M090X100M	E011/U12	E011/A12	10
E011/M090X125	€ 40,10	M 9 x 1.25	Ø 9.3 mm	E011/M090X125M	E011/U12	E011/A12	15
E011/M100X100	€ 38,30	M 10 x 1.0	Ø 10.3 mm	E011/M100X100M	E011/U13	E011/A13	15
E011/M100X125	€ 38,30	M 10 x 1.25	Ø 10.3 mm	E011/M100X125M	E011/U13	E011/A13	15
E011/M100X150	€ 38,30	M 10 x 1.5	Ø 10.4 mm	E011/M100X150M	E011/U13	E011/A13	15
E011/M110X150	€ 42,60	M 11 x 1.5	Ø 11.4 mm	E011/M110X150M	E011/U14	E011/A14	10
E011/M120X100	€ 42,60	M 12 x 1.0	Ø 12.3 mm	E011/M120X100M	E011/U15	E011/A15	10
E011/M120X125	€ 42,60	M 12 x 1.25	Ø 12.3 mm	E011/M120X125M	E011/U15	E011/A15	10
E011/M120X150	€ 42,60	M 12 x 1.5	Ø 12.4 mm	E011/M120X150M	E011/U15	E011/A15	10
E011/M120X175	€ 42,60	M 12 x 1.75	Ø 12.4 mm	E011/M120X175M	E011/U15	E011/A15	10
E011/M140X100	€ 49,50	M 14 x 1.0	-	E011/M140X100M	E011/U16	-	10
E011/M140X125	€ 49,50	M 14 x 1.25	-	E011/M140X125M	E011/U16	-	10
E011/M140X150	€ 49,50	M 14 x 1.5	-	E011/M140X150M	E011/U17	-	10
E011/M140X200	€ 49,50	M 14 x 2.0	-	E011/M140X200M	E011/U17	-	10
E011/M160X150	€ 58,20	M 16 x 1.5	-	E011/M160X150M	E011/U18	-	10
E011/M160X200	€ 58,20	M 16 x 2.0	-	E011/M160X200M	E011/U18	-	10
E011/M180X150	€ 68,60	M 18 x 1.5	-	E011/M180X150M	E011/U20	-	5
E011/M180X200	€ 68,60	M 18 x 2.0	-	E011/M180X200M	E011/U20	-	5
E011/M180X250	€ 68,60	M 18 x 2.5	-	E011/M180X250M	E011/U20	-	5
E011/M200X150	€ 74,60	M 20 x 1.5	-	E011/M200X150M	E011/U21	-	5
E011/M200X200	€ 74,60	M 20 x 2.0	-	E011/M200X200M	E011/U21	-	5
E011/M200X250	€ 74,60	M 20 x 2.5	-	E011/M200X250M	E011/U21	-	5
E011/M220X150	€ 85,00	M 22 x 1.5	-	E011/M220X150M	E011/U22	-	5
E011/M220X200	€ 85,00	M 22 x 2.0	-	E011/M220X200M	E011/U22	-	5
E011/M220X250	€ 85,00	M 22 x 2.5	-	E011/M220X250M	E011/U22	-	5
E011/M240X150	€ 96,30	M 24 x 1.5	-	E011/M240X150M	E011/U23	-	5
E011/M240X200	€ 96,30	M 24 x 2.0	-	E011/M240X200M	E011/U23	-	5
E011/M240X300	€ 96,30	M 24 x 3.0	-	E011/M240X300M	E011/U23	-	5

E011-MX2

KIT RIPARAZIONE FILETTI METRICI F-COIL

Adatti per la rigenerazione delle filettature o per ottenere delle maschiature molto resistenti in materiali teneri

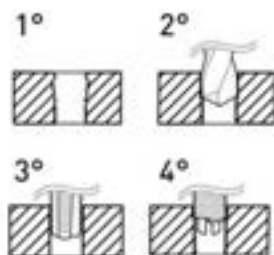

Valigetta

Art.	€	Dimensioni	Maschi STI	Utensile montaggio	Inserti filettati	Quantità inserti
E011/M260X150	€ 274,00	M 26 x 1.5	E011/M260X150M	E011/UM260X150	E010/M260X150E15	10
E011/M270X150	€ 274,00	M 27 x 1.5	E011/M270X150M	E011/UM270X150	E010/M270X150E15	10
E011/M270X200	€ 274,00	M 27 x 2.0	E011/M270X200M	E011/UM270X200	E010/M270X200E15	10
E011/M270X300	€ 274,00	M 27 x 3.0	E011/M270X300M	E011/UM270X300	E010/M270X300E15	10
E011/M280X150	€ 274,00	M 28 x 1.5	E011/M280X150M	E011/UM280X150	E010/M280X150E15	10
E011/M300X150	€ 326,00	M 30 x 1.5	E011/M300X150M	E011/UM300X150	E010/M300X150E15	10
E011/M300X200	€ 326,00	M 30 x 2.0	E011/M300X200M	E011/UM300X200	E010/M300X200E15	10
E011/M300X350	€ 326,00	M 30 x 3.5	E011/M300X350M	E011/UM300X350	E010/M300X350E15	10
E011/M330X200	€ 336,00	M 33 x 2.0	E011/M330X200M	E011/UM330X200	E010/M330X200E15	10
E011/M330X350	€ 336,00	M 33 x 3.5	E011/M330X350M	E011/UM330X350	E010/M330X350E15	10
E011/M360X150	€ 359,00	M 36 x 1.5	E011/M360X150M	E011/UM360X150	E010/M360X150E15	10
E011/M360X200	€ 359,00	M 36 x 2.0	E011/M360X200M	E011/UM360X200	E010/M360X200E15	10
E011/M360X300	€ 359,00	M 36 x 3.0	E011/M360X300M	E011/UM360X300	E010/M360X300E15	10
E011/M360X400	€ 359,00	M 36 x 4.0	E011/M360X400M	E011/UM360X400	E010/M360X400E15	10
E011/M390X300	€ 456,00	M 39 x 3.0	E011/M390X300M	E011/UM390X300	E010/M390X300E15	10
E011/M390X400	€ 522,00	M 39 x 4.0	E011/M390X400M	E011/UM390X400	E010/M390X400E15	10
E011/M400X300	€ 522,00	M 40 x 3.0	E011/M400X300M	E011/UM400X300	E010/M400X300E15	10
E011/M420X300	€ 522,00	M 42 x 3.0	E011/M420X300M	E011/UM420X300	E010/M420X300E15	10
E011/M420X450	€ 700,00	M 42 x 4.5	E011/M420X450M	E011/UM420X450	E010/M420X450E15	10
E011/M450X300	€ 633,00	M 45 x 3.0	E011/M450X300M	E011/UM450X300	E010/M450X300E15	10
E011/M450X450	€ 722,00	M 45 x 4.5	E011/M450X450M	E011/UM450X450	E010/M450X450E15	10
E011/M480X300	€ 633,00	M 48 x 3.0	E011/M480X300M	E011/UM480X300	E010/M480X300E15	10
E011/M480X500	€ 884,00	M 48 x 5.0	E011/M480X500M	E011/UM480X500	E010/M480X500E15	10
E011/M500X300	€ 700,00	M 50 x 3.0	E011/M500X300M	E011/UM500X300	E010/M500X300E15	10
E011/M520X300	€ 945,00	M 52 x 3.0	E011/M520X300M	E011/UM520X300	E010/M520X300E15	10
E011/M520X500	€ 1100,00	M 52 x 5.0	E011/M520X500M	E011/UM520X500	E010/M520X500E15	10

E011-MXC

KIT RIPARAZIONE FILETTI METRICI CANDELE F-COIL

Specifico per riparazioni o rinforzi sedi candele

HSS INOX

Append.

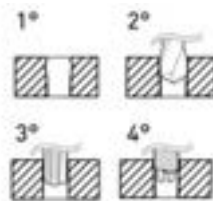

Art.	€	Misura	Utensile montaggio	Maschi STI	Inseriti filettati
E011/M060X100C	€ 41,60	M 6 x 1.0	E011/U09	E011/M060X100M	10
E011/M080X125C	€ 41,60	M 8 x 1.25	E011/U11	E011/M080X125M	10
E011/M100X100C	€ 44,10	M 10 x 1.0	E011/U13	E011/M100X100M	10
E011/M100X125C	€ 44,10	M 10 x 1.25	E011/U13	E011/M100X125M	10
E011/M100X150C	€ 44,10	M 10 x 1.5	E011/U13	E011/M100X150M	10
E011/M120X125C	€ 52,20	M 12 x 1.25	E011/U15	E011/M120X125M	10
E011/M140X125C	€ 59,30	M 14 x 1.25	E011/U17	E011/M140X125M	5 x E010/M140X125E084 - 5 x E010/M140X125E124 - 5 x E010/M140X

E010-MXEXC

INSERTO FILETTATO INOX

Specifico per riparazioni o rinforzi sedi candele. A sezione romboidale, con forma a molla, che crea due filettature perfettamente concentriche; una esterna che si accoppia con il foro filettato precedentemente eseguito e una interna che accoglie la vite

HSS INOX

Append.



Art.	€	Dimensioni	H	Pack
E010/M140X125E084	€ 0,76	M 14 x 1.25	8.4 mm	10
E010/M140X125E124	€ 0,68	M 14 x 1.25	12.4 mm	10
E010/M140X125E164	€ 0,75	M 14 x 1.25	16.4 mm	10

E011/M140X125B

€ 63,10

KIT METRICO DI RIPARAZIONE CON FILETTI A BUSSOLA PER CANDELE

Specifico per riparazioni o rinforzi sedi candele



HSS INOX

17 Pcs Append.

Maschi STI	E011/M140X125MCB
Inseriti filettati	4 x H 9.5 mm - 4 x H 11.2 mm - 4 x H 12.7 mm - 4 x H 17.5 mm

E011-M140X125EX

KIT FILETTI A BUSSOLA PER CANDELE

Specifico per riparazioni o rinforzi sedi candele

HSS INOX

Append.



Art.	€	Misura	H	Pack
E011/M140X125E095	€ 3,72	M 14 x 1.25	9.5 mm	10
E011/M140X125E112	€ 3,90	M 14 x 1.25	11.2 mm	10
E011/M140X125E127	€ 3,90	M 14 x 1.25	12.7 mm	10
E011/M140X125E175	€ 4,15	M 14 x 1.25	17.5 mm	10

E011/M140X125MCB

€ 37,20

MASCHIO COMBINATO

Specifico per creazione di filettature di ripristino su sedi candele

HSS INOX

Misura	M 16 x 1.25
Esagono	18 mm
L	70 mm
l	32mm

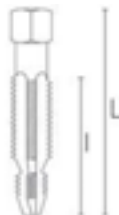

HSS INOX

33 Pcs Scatola

Misure	8 mm - 10 mm - 12 mm
Maschi STI	M8x1 - M10x1 - M10x1.25 - M12x1 - M12x1.25 - M14x1.25



E011/MC

€ 184,00

KIT METRICA DI RIPARAZIONE CON FILETTI A BUSSOLA PER CANDELETTE

Specifico per riparazioni o rinforzi sedi candelette



E011/BSW

€ 218,00

KIT RIPARAZIONE FILETTI BSW F-COIL 1/4-1/2

Adatti per la rigenerazione delle filettature o per ottenere delle maschiature molto resistenti in materiali teneri



HSS

INOX

115 Pcs

Valigetta

Misure	BSW 1/4" - 1/2"
Maschi STI	1/4"x20-5/16"x18-3/8"x16-7/16"x14-1/2"x12
Punte	6.6 mm - 8.3 mm - 9.9 mm - 11.5 mm - 13.0 mm
Inseri filettati	1/4"=25 5/16"=25 3/8"=25 7/16"=10 1/2"=10
Utensile montaggio	5 Pz
Attrezzo rottura	5 Pz

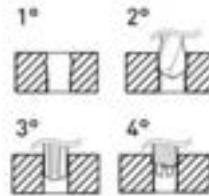

E011-BSWX

KIT RIPARAZIONE FILETTI BSW F-COIL

Adatti per la rigenerazione delle filettature o per ottenere delle maschiature molto resistenti in materiali teneri



HSS

INOX

Append.

Art.	€	Filetto	Punta	Maschi STI	Utensile montaggio	Attrezzo rottura	Inseri filettati	Quantità inserti
E011/BSW1/8	€ 34,20	1/8" x 40	Ø 3.4 mm	E011/BSW1/8M	E011/U04	E011/A4	E010/BSW1/8E15	20
E011/BSW3/16	€ 34,20	3/16" x 24	Ø 5.0 mm	E011/BSW3/16M	E011/U08	E011/A8	E010/BSW3/16E15	20
E011/BSW1/4	€ 31,10	1/4" x 20	Ø 6.7 mm	E011/BSW1/4M	E011/U09	E011/A9	E010/BSW1/4E15	20
E011/BSW5/16	€ 37,50	5/16" x 18	Ø 8.3 mm	E011/BSW5/16M	E011/U10	E011/A11	E010/BSW5/16E15	20
E011/BSW3/8	€ 39,90	3/8" x 16	Ø 9.9 mm	E011/BSW3/8M	E011/U12	E011/A12	E010/BSW3/8E15	15
E011/BSW7/16	€ 44,40	7/16" x 14	Ø 11.5 mm	E011/BSW7/16M	E011/U14	E011/A14	E010/BSW7/16E15	10
E011/BSW1/2	€ 48,40	1/2" x 12	Ø 13.0 mm	E011/BSW1/2M	E011/U15	E011/A15	E010/BSW1/2E15	10
E011/BSW9/16	€ 63,90	9/16" x 12	-	E011/BSW9/16M	E011/U16	-	E010/BSW9/16E15	10
E011/BSW5/8	€ 63,90	5/8" x 11	-	E011/BSW5/8M	E011/U18	-	E010/BSW5/8E15	10
E011/BSW3/4	€ 80,80	3/4" x 10	-	E011/BSW3/4M	E011/U20	-	E010/BSW3/4E15	5
E011/BSW7/8	€ 97,60	7/8" x 9	-	E011/BSW7/8M	E011/U22	-	E010/BSW7/8E15	5
E011/BSW1	€ 93,20	1" x 8	-	E011/BSW1M	E011/U23	-	E010/BSW1E15	4



E011/BSF

€ 218,00

KIT RIPARAZIONE FILETTI BSF F-COIL 1/4-1/2

Adatti per la rigenerazione delle filettature o per ottenere delle maschiature molto resistenti in materiali teneri



HSS

115 Pcs

Valigetta

Misure	BSF 1/4" - 1/2"
Maschi STI	1/4"x26-5/16"x22-3/8"x20-7/16"x18-1/2"x16
Punte	6.6 mm - 8.3 mm - 9.9 mm - 11.5 mm - 13.0 mm
Inseri filettati	1/4"=25 5/16"=25 3/8"=25 7/16"=10 1/2"=10
Utensile montaggio	5 Pz
Attrezzo rottura	5 Pz

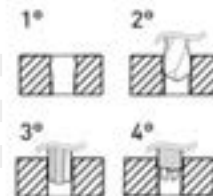

E011-BSFX

KIT RIPARAZIONE FILETTI BSF F-COIL

Adatti per la rigenerazione delle filettature o per ottenere delle maschiature molto resistenti in materiali teneri



HSS

INOX

Append.

Art.	€	Filetto	Punta	Maschi STI	Utensile montaggio	Attrezzo rottura	Inseri filettati	Quantità inserti
E011/BSF3/16	€ 34,20	3/16" x 32	Ø 5.0 mm	E011/BSF3/16M	E011/U07	E011/A06	E010/BSF3/16E15	20
E011/BSF1/4	€ 31,10	1/4" x 26	Ø 6.6 mm	E011/BSF1/4M	E011/U09	E011/A09	E010/BSF1/4E15	20
E011/BSF5/16	€ 37,50	5/16" x 22	Ø 8.3 mm	E011/BSF5/16M	E011/U11	E011/A11	E010/BSF5/16E15	20
E011/BSF3/8	€ 39,90	3/8" x 20	Ø 9.9 mm	E011/BSF3/8M	E011/U13	E011/A13	E010/BSF3/8E15	15
E011/BSF7/16	€ 44,40	7/16" x 18	Ø 11.5 mm	E011/BSF7/16M	E011/U14	E011/A14	E010/BSF7/16E15	10
E011/BSF1/2	€ 48,40	1/2" x 16	Ø 13.0 mm	E011/BSF1/2M	E011/U15	E011/A15	E010/BSF1/2E15	10
E011/BSF9/16	€ 63,90	9/16" x 16	-	E011/BSF9/16M	E011/U16	-	E010/BSF9/16E15	10
E011/BSF5/8	€ 63,90	5/8" x 14	-	E011/BSF5/8M	E011/U18	-	E010/BSF5/8E15	10
E011/BSF3/4	€ 80,80	3/4" x 12	-	E011/BSF3/4M	E011/U20	-	E010/BSF3/4E15	5
E011/BSF7/8	€ 97,60	7/8" x 11	-	E011/BSF7/8M	E011/U22	-	E010/BSF7/8E15	5
E011/BSF1	€ 93,20	1" x 10	-	E011/BSF1M	E011/U23	-	E010/BSF1E15	4



E011-BSPX
KIT RIPARAZIONE FILETTI BSP F-COIL

Adatti per la rigenerazione delle filettature o per ottenere delle maschiature molto resistenti in materiali teneri

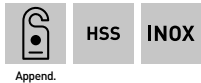

Art.	€	Filetto	Maschi	Inseri filettati	Quantità inserti
E011/BSP1/8	€ 69,60	1/8" x 28	E011/BSP1/8M	E010/BSP1/8ME15	10
E011/BSP1/4	€ 78,40	1/4" x 19	E011/BSP1/4M	E010/BSP1/4ME15	10
E011/BSP3/8	€ 86,10	3/8" x 19	E011/BSP3/8M	E010/BSP3/8ME15	10
E011/BSP1/2	€ 110,00	1/2" x 14	E011/BSP1/2M	E010/BSP1/2ME15	10
E011/BSP5/8	€ 224,00	5/8" x 14	E011/BSP5/8M	E010/BSP5/8ME15	10
E011/BSP3/4	€ 224,00	3/4" x 14	E011/BSP3/4M	E010/BSP3/4ME15	10
E011/BSP7/8	€ 311,00	7/8" x 14	E011/BSP7/8M	E010/BSP7/8ME15	10
E011/BSP1	€ 314,00	1" x 11	E011/BSP1M	E010/BSP1ME15	10

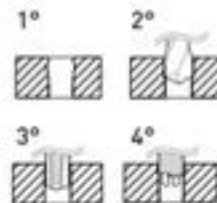
E011/UNC
€ 218,00
SERIE RIPARAZIONE FILETTI UNC F-COIL 1/4-1/2

Adatti per la rigenerazione delle filettature o per ottenere delle maschiature molto resistenti in materiali teneri



Misure	UNC 1/4" - 1/2"
Maschi STI	1/4"x20-5/16"x18-3/8"x16-7/16"x14-1/2"x13
Punte	6.7 mm - 8.3 mm - 9.8 mm - 11.5 mm - 13.0 mm
Inseri filettati	1/4"=25 5/16"=25 3/8"=25 7/16"=10 1/2"=10
Utensile montaggio	5 Pz
Attrezzo rottura	5 Pz

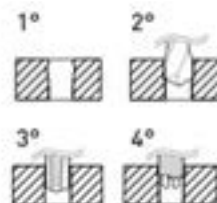

E011-UNCX
KIT RIPARAZIONE FILETTI UNC F-COIL

Adatti per la rigenerazione delle filettature o per ottenere delle maschiature molto resistenti in materiali teneri

Art.	€	Filetto	Punte	Maschi STI	Utensile montaggio	Attrezzo rottura	Inseri filettati	Quantità inserti
E011/UNCN02	€ 36,80	No. 2 x 56	Ø 2.4 mm	E011/UNCN02M	E011/U02	E011/A02	E010/UNCN02E15	20
E011/UNCN04	€ 33,40	No. 4 x 40	Ø 3.1 mm	E011/UNCN04M	E011/U04	E011/A04	E010/UNCN04E15	20
E011/UNCN05	€ 33,40	No. 5 x 40	Ø 3.4 mm	E011/UNCN05M	E011/U04	E011/A04	E010/UNCN05E15	20
E011/UNCN06	€ 33,40	No. 6 x 32	Ø 3.8 mm	E011/UNCN06M	E011/U05	E011/A05	E010/UNCN06E15	20
E011/UNCN08	€ 33,40	No. 8 x 32	Ø 4.4 mm	E011/UNCN08M	E011/U06	E011/A06	E010/UNCN08E15	20
E011/UNCN10	€ 33,40	No. 10 x 24	Ø 5.2 mm	E011/UNCN10M	E011/U07	E011/A06	E010/UNCN10E15	20
E011/UNCN12	€ 33,40	No. 12 x 24	Ø 5.8 mm	E011/UNCN12M	E011/U08	E011/A08	E010/UNCN12E15	20
E011/UNC1/4	€ 30,20	1/4" x 20	Ø 6.7 mm	E011/UNC1/4M	E011/U09	E011/A09	E010/UNC1/4E15	20
E011/UNC5/16	€ 36,70	5/16" x 18	Ø 8.3 mm	E011/UNC5/16M	E011/U10	E011/A11	E010/UNC5/16E15	20
E011/UNC3/8	€ 39,00	3/8" x 16	Ø 9.9 mm	E011/UNC3/8M	E011/U06	E011/A06	E010/UNC3/8E15	20
E011/UNC7/16	€ 43,50	7/16" x 14	Ø 11.6 mm	E011/UNC7/16M	E011/U14	E011/A14	E010/UNC7/16E15	10
E011/UNC1/2	€ 47,60	1/2" x 13	Ø 13.0 mm	E011/UNC1/2M	E011/U15	E011/A15	E010/UNC1/2E15	10
E011/UNC9/16	€ 63,00	9/16" x 12	-	E011/UNC9/16M	E011/U16	-	E010/UNC9/16E15	10
E011/UNC5/8	€ 63,00	5/8" x 1	-	E011/UNC5/8M	E011/U18	-	E010/UNC5/8E15	10
E011/UNC3/4	€ 79,90	3/4" x 10	-	E011/UNC3/4M	E011/U20	-	E010/UNC3/4E15	5
E011/UNC7/8	€ 96,70	7/8" x 9	-	E011/UNC7/8M	E011/U22	-	E010/UNC7/8E15	5
E011/UNC1	€ 92,30	1" x 8	-	E011/UNC1M	E011/U23	-	E010/UNC1E15	4

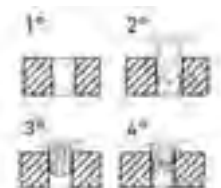

Append.

E011/UNF
€ 218,00
KIT RIPARAZIONE FILETTI UNF F-COIL 1/4-1/2

Adatti per la rigenerazione delle filettature o per ottenere delle maschiature molto resistenti in materiali teneri



Misure	UNF 1/4" - 1/2"
Maschi STI	1/4"x28-5/16"x24-3/8"x24-7/16"x20-1/2"x20
Punte	6.7 mm - 8.3 mm - 9.8 mm - 11.5 mm - 13.0 mm
Inseri filettati	1/4"=25 5/16"=25 3/8"=25 7/16"=10 - 1/2"=10
Utensile montaggio	5 Pz
Attrezzo rottura	5 Pz

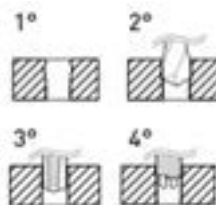



E011-UNFX

KIT RIPARAZIONE FILETTI UNF F-COIL

Adatti per la rigenerazione delle filettature o per ottenere delle maschiature molto resistenti in materiali teneri



Append.

Art.	€	Filetto	Punte	Maschi STI	Utensile montaggio	Attrezzo rottura	Inserti filettati	Quantità inserti
E011/UNFN06	€ 33,40	No. 6 x 40	Ø 3.8 mm	E011/UNFN06M	E011/U05	E011/A05	E010/UNFN06E15	20
E011/UNFN08	€ 33,40	No. 8 x 36	Ø 4.4 mm	E011/UNFN08M	E011/U06	E011/A06	E010/UNFN08E15	20
E011/UNFN10	€ 33,40	No. 10 x 32	Ø 5.1 mm	E011/UNFN10M	E011/U08	E011/A08	E010/UNFN10E15	20
E011/UNF1/4	€ 30,20	1/4" x 28	Ø 6.7 mm	E011/UNF1/4M	E011/U09	E011/A09	E010/UNF1/4E15	20
E011/UNF5/16	€ 36,70	5/16" x 24	Ø 8.3 mm	E011/UNF5/16M	E011/U11	E011/A11	E010/UNF5/16E15	20
E011/UNF3/8	€ 39,00	3/8" x 24	Ø 9.8 mm	E011/UNF3/8M	E011/U13	E011/A13	E010/UNF3/8E15	15
E011/UNF7/16	€ 43,50	7/16" x 20	Ø 11.5 mm	E011/UNF7/16M	E011/U14	E011/A14	E010/UNF7/16E15	10
E011/UNF1/2	€ 47,60	1/2" x 20	Ø 13.0 mm	E011/UNF1/2M	E011/U15	E011/A15	E010/UNF1/2E15	10
E011/UNF9/16	€ 63,00	9/16" x 18	-	E011/UNF9/16M	E011/U16	-	E010/UNF9/16E15	10
E011/UNF5/8	€ 63,00	5/8" x 18	-	E011/UNF5/8M	E011/U18	-	E010/UNF5/8E15	10
E011/UNF3/4	€ 79,90	3/4" x 16	-	E011/UNF3/4M	E011/U21	-	E010/UNF3/4E15	5
E011/UNF7/8	€ 96,70	7/8" x 14	-	E011/UNF7/8M	E011/U22	-	E010/UNF7/8E15	5
E011/UNF1	€ 92,30	1" x 12	-	E011/UNF112M	E011/U23	-	E010/UNF1E15	4

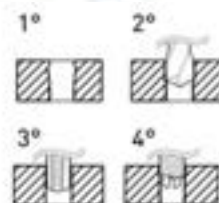

E010-MXE1

INSERTO FILETTATO INOX H=1XD

A sezione romboidale, con forma a molla, che crea due filettature perfettamente concentriche; una esterna che si accoppia con il foro precedentemente filettato con il maschio apposito ed una interna dove si andrà ad avvitare la vite di fissaggio



Append.

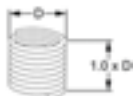

Art.	€	D	Pack
E010/M020X040E1	€ 0,65	M 2 x 0.4	25
E010/M022X045E1	€ 0,65	M 2.2 x 0.45	25
E010/M025X045E1	€ 0,20	M 2.5 x 0.45	25
E010/M030X050E1	€ 0,20	M 3 x 0.5	25
E010/M035X060E1	€ 0,22	M 3.5 x 0.6	25
E010/M040X070E1	€ 0,20	M 4 x 0.7	25
E010/M050X080E1	€ 0,22	M 5 x 0.8	25
E010/M060X100E1	€ 0,25	M 6 x 1.0	25
E010/M070X100E1	€ 0,26	M 7 x 1.0	25
E010/M080X100E1	€ 0,29	M 8 x 1.0	25
E010/M080X125E1	€ 0,25	M 8 x 1.25	25
E010/M090X125E1	€ 0,35	M 9 x 1.25	25
E010/M100X100E1	€ 0,31	M 10 x 1.0	25
E010/M100X125E1	€ 0,31	M 10 x 1.25	25
E010/M100X150E1	€ 0,31	M 10 x 1.5	25
E010/M110X150E1	€ 0,53	M 11 x 1.5	10
E010/M120X100E1	€ 0,47	M 12 x 1.0	10
E010/M120X125E1	€ 0,47	M 12 x 1.25	10
E010/M120X150E1	€ 0,47	M 12 x 1.5	10
E010/M120X175E1	€ 0,47	M 12 x 1.75	10
E010/M140X100E1	€ 0,80	M 14 x 1.0	10
E010/M140X125E1	€ 0,66	M 14 x 1.25	10
E010/M140X150E1	€ 0,66	M 14 x 1.5	10
E010/M140X200E1	€ 0,66	M 14 x 2.0	10
E010/M160X150E1	€ 0,90	M 16 x 1.5	10
E010/M160X200E1	€ 0,90	M 16 x 2.0	10
E010/M180X150E1	€ 1,30	M 18 x 1.5	10
E010/M180X200E1	€ 1,30	M 18 x 2.0	10
E010/M180X250E1	€ 1,30	M 18 x 2.5	10
E010/M200X150E1	€ 1,52	M 20 x 1.5	10
E010/M200X200E1	€ 1,52	M 20 x 2.0	10
E010/M200X250E1	€ 1,52	M 20 x 2.5	10
E010/M220X150E1	€ 1,65	M 22 x 1.5	5
E010/M220X200E1	€ 1,65	M 22 x 2.0	5
E010/M220X250E1	€ 1,65	M 22 x 2.5	5
E010/M240X150E1	€ 2,07	M 24 x 1.5	5
E010/M240X200E1	€ 2,07	M 24 x 2.0	5
E010/M240X300E1	€ 2,07	M 24 x 3.0	5



E010-MXE15
**INSERTO FILETTATO INOX
H=1,5XD**

A sezione romboidale, con forma a molla, che crea due filettature perfettamente concentriche; una esterna che si accoppia con il foro precedentemente filettato con il maschio apposito ed una interna dove si andrà ad avvitare la vite di fissaggio

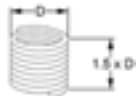
E010-MXE2
**INSERTO FILETTATO INOX
H=2XD**

A sezione romboidale, con forma a molla, che crea due filettature perfettamente concentriche; una esterna che si accoppia con il foro precedentemente filettato con il maschio apposito ed una interna dove si andrà ad avvitare la vite di fissaggio

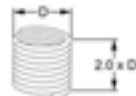

Art.	€	D	Pack
E010/M020X040E15	€ 0,84	M 2 x 0.4	25
E010/M022X045E15	€ 0,84	M 2.2 x 0.45	25
E010/M025X045E15	€ 0,21	M 2.5 x 0.45	25
E010/M030X050E15	€ 0,21	M 3 x 0.5	25
E010/M035X060E15	€ 0,25	M 3.5 x 0.6	25
E010/M040X070E15	€ 0,21	M 4 x 0.7	25
E010/M050X080E15	€ 0,19	M 5 x 0.8	25
E010/M060X100E15	€ 0,20	M 6 x 1.0	25
E010/M070X100E15	€ 0,31	M 7 x 1.0	25
E010/M080X100E15	€ 0,29	M 8 x 1.0	25
E010/M080X125E15	€ 0,25	M 8 x 1.25	25
E010/M090X100E15	€ 0,55	M 9 x 1.0	25
E010/M090X125E15	€ 0,47	M 9 x 1.25	25
E010/M100X100E15	€ 0,35	M 10 x 1.0	25
E010/M100X125E15	€ 0,35	M 10 x 1.25	25
E010/M100X150E15	€ 0,35	M 10 x 1.5	25
E010/M110X150E15	€ 0,59	M 11 x 1.5	10
E010/M120X100E15	€ 0,54	M 12 x 1.0	10
E010/M120X125E15	€ 0,54	M 12 x 1.25	10
E010/M120X150E15	€ 0,54	M 12 x 1.5	10
E010/M120X175E15	€ 0,54	M 12 x 1.75	10
E010/M140X100E15	€ 0,64	M 14 x 1.0	10
E010/M140X125E15	€ 0,64	M 14 x 1.25	10
E010/M140X150E15	€ 0,64	M 14 x 1.50	10
E010/M140X200E15	€ 0,64	M 14 x 2.0	10
E010/M160X150E15	€ 0,74	M 16 x 1.5	10
E010/M160X200E15	€ 0,74	M 16 x 2.0	10
E010/M180X150E15	€ 1,14	M 18 x 1.5	10
E010/M180X200E15	€ 1,14	M 18 x 2.0	10
E010/M180X250E15	€ 1,14	M 18 x 2.5	10
E010/M200X150E15	€ 1,46	M 20 x 1.5	10
E010/M200X200E15	€ 1,46	M 20 x 2.0	10
E010/M200X250E15	€ 1,46	M 20 x 2.5	10
E010/M220X150E15	€ 2,07	M 22 x 1.5	5
E010/M220X200E15	€ 2,07	M 22 x 2.0	5
E010/M220X250E15	€ 2,07	M 22 x 2.5	5
E010/M240X150E15	€ 2,20	M 24 x 1.5	5
E010/M240X200E15	€ 2,20	M 24 x 2.0	5
E010/M240X300E15	€ 2,20	M 24 x 3.0	5
E010/M260X150E15	€ 4,12	M 26 x 1.5	5
E010/M270X150E15	€ 4,12	M 27 x 1.5	5
E010/M270X200E15	€ 4,12	M 27 x 2.0	5
E010/M270X300E15	€ 4,12	M 27 x 3.0	5
E010/M280X150E15	€ 4,12	M 28 x 1.5	5
E010/M300X150E15	€ 5,00	M 30 x 1.5	5
E010/M300X200E15	€ 5,00	M 30 x 2.0	5
E010/M300X350E15	€ 5,00	M 30 x 3.5	5
E010/M330X200E15	€ 5,90	M 33 x 2.0	5
E010/M330X350E15	€ 5,90	M 33 x 3.5	5
E010/M360X150E15	€ 5,90	M 36 x 1.5	5
E010/M360X200E15	€ 5,90	M 36 x 2.0	5
E010/M360X300E15	€ 5,90	M 36 x 3.0	5
E010/M360X400E15	€ 5,90	M 36 x 4.0	5
E010/M390X300E15	€ 13,00	M 39 x 3.0	5
E010/M390X400E15	€ 13,00	M 39 x 4.0	5
E010/M400X300E15	€ 18,10	M 40 x 3.0	5
E010/M420X300E15	€ 18,10	M 42 x 3.0	5
E010/M420X450E15	€ 18,10	M 42 x 4.5	5
E010/M450X300E15	€ 21,70	M 45 x 3.0	5
E010/M450X450E15	€ 21,70	M 45 x 4.5	5
E010/M480X300E15	€ 21,70	M 48 x 3.0	5
E010/M480X500E15	€ 28,50	M 48 x 5.0	5
E010/M500X300E15	€ 28,50	M 50 x 3.0	5
E010/M520X300E15	€ 30,60	M 52 x 3.0	5
E010/M520X500E15	€ 30,60	M 52 x 5.0	5

Art.	€	D	Pack
E010/M020X040E2	€ 0,98	M 2 x 0.4	25
E010/M022X045E2	€ 0,98	M 2.2 x 0.45	25
E010/M025X045E2	€ 0,22	M 2.5 x 0.45	25
E010/M030X050E2	€ 0,22	M 3 x 0.5	25
E010/M035X060E2	€ 0,25	M 3.5 x 0.6	25
E010/M040X070E2	€ 0,22	M 4 x 0.7	25
E010/M050X080E2	€ 0,25	M 5 x 0.8	25
E010/M060X100E2	€ 0,29	M 6 x 1.0	25
E010/M070X100E2	€ 0,35	M 7 x 1.0	25
E010/M080X100E2	€ 0,37	M 8 x 1.0	25
E010/M080X125E2	€ 0,35	M 8 x 1.25	25
E010/M090X125E2	€ 0,47	M 9 x 1.25	25
E010/M100X100E2	€ 0,40	M 10 x 1.0	25
E010/M100X125E2	€ 0,40	M 10 x 1.25	25
E010/M100X150E2	€ 0,40	M 10 x 1.5	25
E010/M110X150E2	€ 0,64	M 11 x 1.5	10
E010/M120X100E2	€ 0,61	M 12 x 1.0	10
E010/M120X125E2	€ 0,61	M 12 x 1.25	10
E010/M120X150E2	€ 0,61	M 12 x 1.5	10
E010/M120X175E2	€ 0,61	M 12 x 1.75	10
E010/M140X100E2	€ 0,79	M 14 x 1.0	10
E010/M140X125E2	€ 0,79	M 14 x 1.25	10
E010/M140X150E2	€ 0,79	M 14 x 1.5	10
E010/M140X200E2	€ 0,79	M 14 x 2.0	10
E010/M160X150E2	€ 1,16	M 16 x 1.5	10
E010/M160X200E2	€ 1,16	M 16 x 2.0	10
E010/M180X150E2	€ 2,07	M 18 x 1.5	10
E010/M180X200E2	€ 2,07	M 18 x 2.0	10
E010/M180X250E2	€ 2,07	M 18 x 2.5	10
E010/M200X150E2	€ 2,47	M 20 x 1.5	10
E010/M200X200E2	€ 2,47	M 20 x 2.0	10
E010/M200X250E2	€ 2,47	M 20 x 2.5	10
E010/M220X150E2	€ 2,62	M 22 x 1.5	5
E010/M220X200E2	€ 2,62	M 22 x 2.0	5
E010/M220X250E2	€ 2,62	M 22 x 2.5	5
E010/M240X150E2	€ 2,74	M 24 x 1.5	5
E010/M240X200E2	€ 2,74	M 24 x 2.0	5
E010/M240X300E2	€ 2,74	M 24 x 3.0	5



E010-MXE25

INSERTO FILETTATO INOX
H=2,5XD

A sezione romboidale, con forma a molla, che crea due filettature perfettamente concentriche; una esterna che si accoppia con il foro precedentemente filettato con il maschio apposito ed una interna dove si andrà ad avvitare la vite di fissaggio



INOX

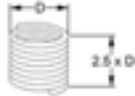

Art.	€	D	Pack
E010/M020X040E25	€ 1,10	2 x 0.4	25
E010/M022X045E25	€ 1,10	2.2 x 0.45	25
E010/M025X045E25	€ 0,26	2.5 x 0.45	25
E010/M030X050E25	€ 0,26	3 x 0.5	25
E010/M035X060E25	€ 0,29	3.5 x 0.6	25
E010/M040X070E25	€ 0,26	4 x 0.7	25
E010/M050X080E25	€ 0,30	5 x 0.8	25
E010/M060X100E25	€ 0,35	6 x 1.0	25
E010/M070X100E25	€ 0,42	7 x 1.0	25
E010/M080X100E25	€ 0,44	8 x 1.0	25
E010/M080X125E25	€ 0,42	8 x 1.25	25
E010/M090X125E25	€ 0,52	9 x 1.25	25
E010/M100X100E25	€ 0,48	10 x 1.0	25
E010/M100X125E25	€ 0,48	10 x 1.25	25
E010/M100X150E25	€ 0,48	10 x 1.5	25
E010/M110X150E25	€ 0,72	11 x 1.5	10
E010/M120X100E25	€ 0,72	12 x 1.0	10
E010/M120X125E25	€ 0,72	12 x 1.25	10
E010/M120X150E25	€ 0,72	12 x 1.5	10
E010/M120X175E25	€ 0,72	12 x 1.75	10
E010/M140X100E25	€ 0,95	14 x 1.0	10
E010/M140X125E25	€ 0,95	14 x 1.25	10
E010/M140X150E25	€ 0,95	14 x 1.5	10
E010/M140X200E25	€ 0,95	14 x 2.0	10
E010/M160X150E25	€ 1,26	16 x 1.5	10
E010/M160X200E25	€ 1,26	16 x 2.0	10
E010/M180X150E25	€ 2,34	18 x 1.5	10
E010/M180X200E25	€ 2,34	18 x 2.0	10
E010/M180X250E25	€ 2,34	18 x 2.5	10
E010/M200X150E25	€ 2,74	20 x 1.5	10
E010/M200X200E25	€ 2,74	20 x 2.0	10
E010/M200X250E25	€ 2,74	20 x 2.5	10
E010/M220X150E25	€ 3,02	22 x 1.5	5
E010/M220X200E25	€ 3,02	22 x 2.0	5
E010/M220X250E25	€ 3,02	22 x 2.5	5
E010/M240X150E25	€ 3,29	24 x 1.5	5
E010/M240X200E25	€ 3,29	24 x 2.0	5
E010/M240X300E25	€ 3,29	24 x 3.0	5

E010-MXE3

INSERTO FILETTATO INOX
H=3XD

A sezione romboidale, con forma a molla, che crea due filettature perfettamente concentriche; una esterna che si accoppia con il foro precedentemente filettato con il maschio apposito ed una interna dove si andrà ad avvitare la vite di fissaggio



INOX



Art.	€	D	Pack
E010/M020X040E3	€ 1,37	M 2 x 0.4	25
E010/M022X045E3	€ 1,37	M 2.2 x 0.45	25
E010/M025X045E3	€ 0,31	M 2.5 x 0.45	25
E010/M030X050E3	€ 0,31	M 3 x 0.5	25
E010/M035X060E3	€ 0,35	M 3.5 x 0.6	25
E010/M040X070E3	€ 0,29	M 4 x 0.7	25
E010/M050X080E3	€ 0,36	M 5 x 0.8	25
E010/M060X100E3	€ 0,43	M 6 x 1.0	25
E010/M070X100E3	€ 0,49	M 7 x 1.0	25
E010/M080X100E3	€ 0,54	M 8 x 1.0	25
E010/M080X125E3	€ 0,49	M 8 x 1.25	25
E010/M090X125E3	€ 0,61	M 9 x 1.25	25
E010/M100X100E3	€ 0,58	M 10 x 1.0	25
E010/M100X125E3	€ 0,58	M 10 x 1.25	25
E010/M100X150E3	€ 0,58	M 10 x 1.5	25
E010/M110X150E3	€ 0,86	M 11 x 1.5	10
E010/M120X100E3	€ 0,86	M 12 x 1.0	10
E010/M120X125E3	€ 0,86	M 12 x 1.25	10
E010/M120X150E3	€ 0,86	M 12 x 1.5	10
E010/M120X175E3	€ 0,86	M 12 x 1.75	10
E010/M140X100E3	€ 1,16	M 14 x 1.0	10
E010/M140X125E3	€ 1,16	M 14 x 1.25	10
E010/M140X150E3	€ 1,16	M 14 x 1.5	10
E010/M140X200E3	€ 1,37	M 14 x 2.0	10
E010/M160X150E3	€ 1,37	M 16 x 1.5	10
E010/M160X200E3	€ 1,37	M 16 x 2.0	10
E010/M180X150E3	€ 2,74	M 18 x 1.5	10
E010/M180X200E3	€ 2,74	M 18 x 2.0	10
E010/M180X250E3	€ 2,74	M 18 x 2.5	10
E010/M200X150E3	€ 3,17	M 20 x 1.5	10
E010/M200X200E3	€ 3,17	M 20 x 2.0	10
E010/M200X250E3	€ 3,17	M 20 x 2.5	10
E010/M220X150E3	€ 3,44	M 22 x 1.5	5
E010/M220X200E3	€ 3,44	M 22 x 2.0	5
E010/M220X250E3	€ 3,44	M 22 x 2.5	5
E010/M240X150E3	€ 3,84	M 24 x 1.5	5
E010/M240X200E3	€ 3,84	M 24 x 2.0	5
E010/M240X300E3	€ 3,84	M 24 x 3.0	5



E010-MXEXA

INSERTO FILETTATO AUTOBLOCCANTE INOX

A sezione romboidale, con forma a molla, che crea due filettature perfettamente concentriche; una esterna che si accoppia con il foro precedentemente filettato con il maschio apposito ed una interna dove si andrà ad avvitare la vite di fissaggio

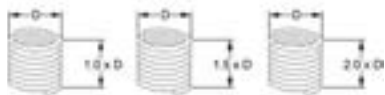

Art.	€	D	Altezza	Pack
E010/M030X050E1A	€ 0,30	M 3 x 0.5	1.0 D	25
E010/M040X070E1A	€ 0,30	M 4 x 0.7	1.0 D	25
E010/M050X080E1A	€ 0,35	M 5 x 0.8	1.0 D	25
E010/M060X100E1A	€ 0,38	M 6 x 1.0	1.0 D	25
E010/M080X125E1A	€ 0,40	M 8 x 1.25	1.0 D	25
E010/M100X150E1A	€ 0,52	M 10 x 1.5	1.0 D	25
E010/M120X175E1A	€ 0,74	M 12 x 1.75	1.0 D	10
E010/M140X200E1A	€ 1,07	M 14 x 2.0	1.0 D	10
E010/M160X200E1A	€ 1,43	M 16 x 2.0	1.0 D	10
E010/M030X050E15A	€ 0,33	M 3 x 0.5	1.5 D	25
E010/M040X070E15A	€ 0,33	M 4 x 0.7	1.5 D	25
E010/M050X080E15A	€ 0,36	M 5 x 0.8	1.5 D	25
E010/M060X100E15A	€ 0,42	M 6 x 1.0	1.5 D	25
E010/M080X125E15A	€ 0,46	M 8 x 1.5	1.5 D	25
E010/M100X150E15A	€ 0,55	M 10 x 1.5	1.5 D	25
E010/M120X175E15A	€ 0,85	M 12 x 1.75	1.5 D	10
E010/M140X200E15A	€ 1,21	M 14 x 2.0	1.5 D	10
E010/M160X200E15A	€ 1,50	M 16 x 2.0	1.5 D	10
E010/M030X050E2A	€ 0,35	M 3 x 0.5	2.0 D	25
E010/M040X070E2A	€ 0,35	M 4 x 0.7	2.0 D	25
E010/M050X080E2A	€ 0,40	M 5 x 0.8	2.0 D	25
E010/M060X100E2A	€ 0,46	M 6 x 1.0	2.0 D	25
E010/M080X125E2A	€ 0,55	M 8 x 1.25	2.0 D	25
E010/M100X150E2A	€ 0,64	M 10 x 1.5	2.0 D	25
E010/M120X175E2A	€ 0,97	M 12 x 1.75	2.0 D	10
E010/M140X200E2A	€ 1,26	M 14 x 2.0	2.0 D	10
E010/M160X200E2A	€ 1,84	M 16 x 2.0	2.0 D	10

E010-BSWXEX

INSERTO FILETTATO INOX BSW H=1,5XD

A sezione romboidale, con forma a molla, che crea due filettature perfettamente concentriche; una esterna che si accoppia con il foro precedentemente filettato con il maschio apposito ed una interna dove si andrà ad avvitare la vite di fissaggio

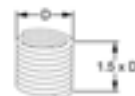

Art.	€	D	Pack
E010/BSW1/8E15	€ 1,01	1/8" x 40	10
E010/BSW3/16E15	€ 1,01	3/16" x 24	10
E010/BSW1/4E15	€ 0,47	1/4" x 20	10
E010/BSW5/16E15	€ 0,55	5/16" x 18	10
E010/BSW3/8E15	€ 0,86	3/8" x 16	10
E010/BSW7/16E15	€ 1,01	7/16" x 14	10
E010/BSW1/2E15	€ 1,01	1/2" x 12	10
E010/BSW9/16E15	€ 3,20	9/16" x 12	5
E010/BSW5/8E15	€ 3,20	5/8" x 11	5
E010/BSW3/4E15	€ 3,66	3/4" x 10	5
E010/BSW7/8E15	€ 5,50	7/8" x 9	5
E010/BSW1E15	€ 5,90	1" x 8	5

E010-BSFXEX

INSERTO FILETTATO INOX BSF H=1,5XD

A sezione romboidale, con forma a molla, che crea due filettature perfettamente concentriche; una esterna che si accoppia con il foro precedentemente filettato con il maschio apposito ed una interna dove si andrà ad avvitare la vite di fissaggio

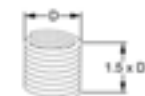

Art.	€	D	Pack
E010/BSF3/16E15	€ 1,01	3/16" x 32	10
E010/BSF1/4E15	€ 0,47	1/4" x 26	10
E010/BSF5/16E15	€ 0,55	5/16" x 22	10
E010/BSF3/8E15	€ 0,86	3/8" x 20	10
E010/BSF7/16E15	€ 1,01	7/16" x 18	10
E010/BSF1/2E15	€ 1,01	1/2" x 16	10
E010/BSF9/16E15	€ 3,48	9/16" x 16	5
E010/BSF5/8E15	€ 3,48	5/8" x 14	5
E010/BSF3/4E15	€ 4,39	3/4" x 12	5
E010/BSF7/8E15	€ 5,50	7/8" x 11	5
E010/BSF1E15	€ 5,50	1" x 10	5



E010-BSPXEX

INSERTO FILETTATO INOX BSP H=1,5XD

A sezione romboidale, con forma a molla, che crea due filettature perfettamente concentriche; una esterna che si accoppia con il foro precedentemente filettato con il maschio apposito ed una interna dove si andrà ad avvitare la vite di fissaggio



INOX

Append.

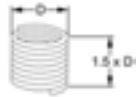

Art.	€	D	Pack
E010/BSP1/8E15	€ 0,78	1/8" x 28	10
E010/BSP1/4E15	€ 0,91	1/4" x 19	10
E010/BSP3/8E15	€ 1,19	3/8" x 19	10
E010/BSP1/2E15	€ 1,36	1/2" x 14	10
E010/BSP5/8E15	€ 3,66	5/8" x 14	5
E010/BSP3/4E15	€ 3,66	3/4" x 14	5
E010/BSP7/8E15	€ 11,00	7/8" x 14	5
E010/BSP1E15	€ 11,00	1" x 11	5

E010-UNFXEX

INSERTO FILETTATO INOX UNF H=1,5XD

A sezione romboidale, con forma a molla, che crea due filettature perfettamente concentriche; una esterna che si accoppia con il foro precedentemente filettato con il maschio apposito ed una interna dove si andrà ad avvitare la vite di fissaggio



INOX

Append.

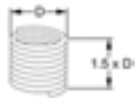

Art.	€	D	Pack
E010/UNFN04E15	€ 0,99	No. 4 x 48	10
E010/UNFN06E15	€ 0,99	No. 6 x 40	10
E010/UNFN08E15	€ 0,99	No. 8 x 36	10
E010/UNFN10E15	€ 0,39	No. 10 x 32	10
E010/UNF1/4E15	€ 0,39	1/4" x 28	10
E010/UNF5/16E15	€ 0,56	5/16" x 24	10
E010/UNF3/8E15	€ 0,81	3/8" x 24	10
E010/UNF7/16E15	€ 1,08	7/16" x 20	10
E010/UNF1/2E15	€ 1,08	1/2" x 20	10
E010/UNF9/16E15	€ 2,25	9/16" x 18	5
E010/UNF5/8E15	€ 2,25	5/8" x 18	5
E010/UNF3/4E15	€ 2,25	3/4" x 16	5
E010/UNF7/8E15	€ 5,80	7/8" x 14	5
E010/UNF1E15	€ 5,80	1" x 12	5

E010-UNCXEX

INSERTO FILETTATO INOX UNC H=1,5XD

A sezione romboidale, con forma a molla, che crea due filettature perfettamente concentriche; una esterna che si accoppia con il foro precedentemente filettato con il maschio apposito ed una interna dove si andrà ad avvitare la vite di fissaggio



INOX

Append.

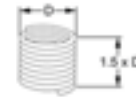

Art.	€	D	Pack
E010/UNCN02E15	€ 1,14	No. 2 x 56	10
E010/UNCN04E15	€ 0,35	No. 4 x 40	10
E010/UNCN05E15	€ 0,42	No. 5 x 40	10
E010/UNCN06E15	€ 0,33	No. 6 x 32	10
E010/UNCN08E15	€ 0,33	No. 8 x 32	10
E010/UNCN10E15	€ 0,37	No. 10 x 24	10
E010/UNCN12E15	€ 0,44	No. 12 x 24	10
E010/UNC1/4E15	€ 0,44	1/4" x 20	10
E010/UNC5/16E15	€ 0,62	5/16" x 18	10
E010/UNC3/8E15	€ 0,81	3/8" x 16	10
E010/UNC7/16E15	€ 1,08	7/16" x 14	10
E010/UNC1/2E15	€ 1,08	1/2" x 13	10
E010/UNC9/16E15	€ 1,16	9/16" x 12	5
E010/UNC5/8E15	€ 2,32	5/8" x 11	5
E010/UNC3/4E15	€ 3,29	3/4" x 10	5
E010/UNC7/8E15	€ 4,94	7/8" x 9	5
E010/UNC1E15	€ 4,94	1" x 8	5

E011-MXM

MASCHI METRICI STI PER F-COIL

Tipo speciale per creazione sede alloggiamento inserto filettato

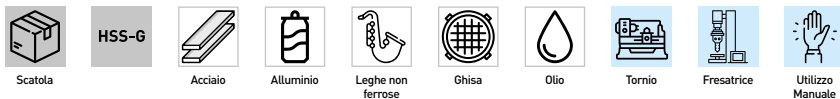

Art.	€	Misura	B	L1	L2	D2	C	Art.	€	Misura	B	L1	L2	D2	C
E011/M020X040M	€ 10,40	M 2 x 0.40	2.5 mm	44.5 mm	9.5 mm	2.8 mm	2.24 mm	E011/M120X175M	€ 19,00	M 12 x 1.75	14.3 mm	95.0 mm	30.0 mm	11.2 mm	9.00 mm
E011/M025X045M	€ 10,40	M 2.5 x 0.45	3.1 mm	48.0 mm	11.0 mm	3.15 mm	2.5 mm	E011/M140X100M	€ 21,60	M 14 x 1.0	15.3 mm	102.0 mm	32.0 mm	12.5 mm	10.00 mm
E011/M030X050M	€ 10,40	M 3 x 0.5	3.6 mm	53.0 mm	13.0 mm	4.0 mm	3.15 mm	E011/M140X125M	€ 21,60	M 14 x 1.25	15.6 mm	102.0 mm	32.0 mm	12.5 mm	10.00 mm
E011/M035X060M	€ 10,40	M 3.5 x 0.6	4.3 mm	53.0 mm	13.0 mm	4.5 mm	3.55 mm	E011/M140X150M	€ 21,60	M 14 x 1.5	16.0 mm	102.0 mm	32.0 mm	12.5 mm	10.00 mm
E011/M040X070M	€ 10,40	M 4 x 0.7	4.9 mm	58 mm	16.0 mm	5.0 mm	4.00 mm	E011/M160X150M	€ 26,80	M 16 x 1.5	18.0 mm	104.0 mm	29.0 mm	14.0 mm	11.20 mm
E011/M050X080M	€ 10,40	M 5 x 0.8	6.0 mm	66.0 mm	19.0 mm	6.3 mm	5.00 mm	E011/M160X200M	€ 26,80	M 16 x 2.0	18.6 mm	112.0 mm	37.0 mm	14.0 mm	11.20 mm
E011/M060X100M	€ 10,40	M 6 x 1.0	7.3 mm	72.0 mm	22.0 mm	8.0 mm	6.30 mm	E011/M180X150M	€ 28,50	M 18 x 1.5	20.0 mm	104.0 mm	29.0 mm	14.0 mm	11.20 mm
E011/M070X100M	€ 12,10	M 7 x 1.0	8.3 mm	72.0 mm	22.0 mm	9.0 mm	7.10 mm	E011/M180X200M	€ 28,50	M 18 x 2.0	20.6 mm	104.0 mm	29.0 mm	14.0 mm	11.20 mm
E011/M080X100M	€ 12,10	M 8 x 1.0	9.3 mm	80.0 mm	24.0 mm	10.0 mm	8.00 mm	E011/M180X250M	€ 28,50	M 18 x 2.5	21.3 mm	118.0 mm	38.0 mm	16.0 mm	12.50 mm
E011/M080X125M	€ 12,10	M 8 x 1.25	9.6 mm	80.0 mm	24.0 mm	8.0 mm	8.00 mm	E011/M200X150M	€ 31,90	M 20 x 1.5	22.0 mm	113.0 mm	33.0 mm	16.0 mm	12.50 mm
E011/M090X100M	€ 13,80	M 9 x 1.0	10.6 mm	85.0 mm	25.0 mm	8.0 mm	6.30 mm	E011/M200X200M	€ 31,90	M 20 x 2.0	22.6 mm	113.0 mm	33.0 mm	16.0 mm	12.50 mm
E011/M090X125M	€ 13,80	M 9 x 1.25	10.6 mm	85.0 mm	25.0 mm	8.0 mm	6.30 mm	E011/M200X250M	€ 31,90	M 20 x 2.5	23.3 mm	118.0 mm	38.0 mm	16.0 mm	12.50 mm
E011/M100X100M	€ 13,80	M 10 x 1.0	11.3 mm	85.0 mm	25.0 mm	8.0 mm	6.30 mm	E011/M220X150M	€ 40,60	M 22 x 1.5	24.0 mm	120.0 mm	35.0 mm	18.0 mm	14.00 mm
E011/M100X125M	€ 13,80	M 10 x 1.25	11.6 mm	85.0 mm	25.0 mm	8.0 mm	6.30 mm	E011/M220X200M	€ 40,60	M 22 x 2.0	24.6 mm	120.0 mm	35.0 mm	18.0 mm	14.00 mm
E011/M100X150M	€ 13,80	M 10 x 1.5	11.9 mm	89.0 mm	29.0 mm	9.0 mm	7.10 mm	E011/M220X250M	€ 40,60	M 22 x 2.5	25.3 mm	130.0 mm	45.0 mm	18.0 mm	14.00 mm
E011/M110X150M	€ 18,10	M 11 x 1.5	12.9 mm	89.0 mm	29.0 mm	9.0 mm	7.10 mm	E011/M240X150M	€ 43,30	M 24 x 1.5	26.0 mm	120.0 mm	35.0 mm	18.0 mm	14.00 mm
E011/M120X100M	€ 18,10	M 12 x 1.0	13.3 mm	95.0 mm	30.0 mm	11.2 mm	9.00 mm	E011/M240X200M	€ 43,30	M 24 x 2.0	26.6 mm	127.0 mm	37.0 mm	20.0 mm	16.00 mm
E011/M120X125M	€ 19,00	M 12 x 1.25	13.6 mm	95.0 mm	30.0 mm	11.2 mm	9.00 mm	E011/M240X300M	€ 43,30	M 24 x 3.0	27.9 mm	138.0 mm	48.0 mm	20.0 mm	16.00 mm
E011/M120X150M	€ 19,00	M 12 x 1.5	14.0 mm	95.0 mm	30.0 mm	11.2 mm	9.00 mm								

E011-MXM2

COPPIA MASCHI METRICI STI PER F-COIL

Tipo speciale per creazione sede alloggiamento inserto filettato



Art.	€	Misura	B	L1	L2	D2	C
E011/M260X150M	€ 143,00	M 26 x 1.5	28.0 mm	127 mm	37 mm	20.0 mm	16.0 mm
E011/M270X150M	€ 143,00	M 27 x 1.5	29.0 mm	127 mm	37 mm	20.0 mm	16.0 mm
E011/M270X200M	€ 143,00	M 27 x 2.0	29.6 mm	127 mm	37 mm	20.0 mm	16.0 mm
E011/M270X300M	€ 143,00	M 27 x 3.0	30.9 mm	151 mm	51 mm	22.4 mm	18.0 mm
E011/M280X150M	€ 173,00	M 28 x 1.5	30.0 mm	127 mm	37 mm	20.0 mm	16.0 mm
E011/M300X150M	€ 173,00	M 30 x 1.5	32.0 mm	137 mm	37 mm	22.4 mm	18.0 mm
E011/M300X200M	€ 173,00	M 30 x 2.0	32.6 mm	137 mm	37 mm	22.4 mm	18.0 mm
E011/M300X350M	€ 173,00	M 30 x 3.5	34.6 mm	162 mm	57 mm	25.0 mm	20.0 mm
E011/M330X200M	€ 173,00	M 33 x 2.0	35.6 mm	144 mm	37 mm	25.0 mm	20.0 mm
E011/M330X350M	€ 173,00	M 33 x 3.5	37.6 mm	162 mm	57 mm	25.0 mm	20.0 mm
E011/M360X150M	€ 199,00	M 36 x 1.5	38.0 mm	150 mm	39 mm	28.0 mm	22.4 mm
E011/M360X200M	€ 199,00	M 36 x 2.0	38.6 mm	150 mm	39 mm	28.0 mm	22.4 mm
E011/M360X300M	€ 199,00	M 36 x 3.0	39.9 mm	170 mm	60 mm	28.0 mm	22.4 mm
E011/M360X400M	€ 199,00	M 36 x 4.0	41.2 mm	170 mm	60 mm	28.0 mm	22.4 mm
E011/M390X300M	€ 300,00	M 39 x 3.0	42.9 mm	149 mm	39 mm	28.0 mm	26.0 mm
E011/M390X400M	€ 256,00	M 39 x 4.0	44.2 mm	187 mm	67 mm	31.5 mm	28.0 mm
E011/M400X300M	€ 256,00	M 40 x 3.0	43.9 mm	149 mm	39 mm	28.0 mm	26.0 mm
E011/M420X300M	€ 423,00	M 42 x 3.0	45.9 mm	165 mm	45 mm	31.5 mm	28.0 mm
E011/M420X450M	€ 278,00	M 42 x 4.5	47.9 mm	187 mm	67 mm	31.5 mm	28.0 mm
E011/M450X300M	€ 423,00	M 45 x 3.0	48.9 mm	175 mm	45 mm	35.5 mm	31.0 mm
E011/M450X450M	€ 323,00	M 45 x 4.5	50.9 mm	200 mm	70 mm	35.5 mm	31.0 mm
E011/M480X300M	€ 522,00	M 48 x 3.0	51.9 mm	175 mm	45 mm	35.5 mm	31.0 mm
E011/M480X500M	€ 356,00	M 48 x 5.0	54.5 mm	200 mm	70 mm	35.5 mm	31.0 mm
E011/M500X300M	€ 389,00	M 50 x 3.0	53.9 mm	175 mm	45 mm	35.5 mm	31.0 mm
E011/M520X300M	€ 722,00	M 52 x 3.0	55.9 mm	193 mm	48 mm	40.0 mm	34.0 mm
E011/M520X500M	€ 611,00	M 52 x 3.0	58.5 mm	221 mm	76 mm	40.0 mm	34.0 mm

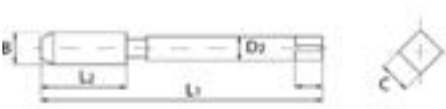



E011-MXMC

MASCHIO COMBINATO METRICO STI PER F-COIL

Tipo speciale per creazione sede alloggiamento inserto filettato



Art.	€	Misura	B1	B2	L3	L2	L1	D2	C
E011/M060X100MC	€ 14,70	M 6 x 1.0	7.3 mm	6 mm	7 mm	28 mm	70 mm	8 mm	6.3 mm
E011/M080X125MC	€ 14,70	M 8 x 1.25	9.6 mm	8 mm	9 mm	32 mm	75 mm	8 mm	6.3 mm
E011/M100X100MC	€ 20,80	M 10 x 1.0	11.3 mm	10 mm	8 mm	30 mm	74 mm	8 mm	6.3 mm
E011/M100X125MC	€ 20,80	M 10 x 1.25	11.6 mm	10 mm	8 mm	30 mm	74 mm	8 mm	6.3 mm
E011/M100X150MC	€ 20,80	M 10 x 1.5	11.9 mm	10 mm	9 mm	37 mm	80 mm	9 mm	7.1 mm
E011/M120X125MC	€ 26,80	M 12 x 1.25	13.6 mm	12 mm	9 mm	32 mm	75 mm	9 mm	7.1 mm
E011/M140X125MC	€ 29,40	M 14 x 1.25	15.6 mm	14 mm	10 mm	45 mm	90 mm	12 mm	9.2 mm
E011/M180X150MC	€ 43,30	M 18 x 1.25	20.0 mm	18 mm	10 mm	47 mm	116 mm	16 mm	12.5 mm

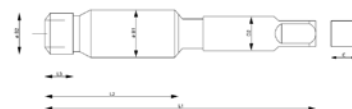

E011-BSWXM

MASCHI BSW STI PER F-COIL

Tipo speciale per creazione sede alloggiamento inserto filettato



Art.	€	Misura	B	L1	L2	D2	C
E011/BSW1/8M	€ 9,60	1/8" x 40	3.9 mm	53.0 mm	13.0 mm	4.0 mm	3.15 mm
E011/BSW3/16M	€ 9,60	3/16" x 24	6.0 mm	56.0 mm	19.0 mm	6.3 mm	5.00 mm
E011/BSW1/4M	€ 9,60	1/4" x 20	7.8 mm	72.0 mm	22.0 mm	8.0 mm	6.30 mm
E011/BSW5/16M	€ 10,40	5/16" x 18	9.6 mm	80.0 mm	24.0 mm	10.0 mm	8.00 mm
E011/BSW3/8M	€ 11,20	3/8" x 16	11.4 mm	85.0 mm	25.0 mm	8.0 mm	6.30 mm
E011/BSW7/16M	€ 12,10	7/16" x 14	13.2 mm	95.0 mm	30.0 mm	11.2 mm	9.00 mm
E011/BSW1/2M	€ 13,40	1/2" x 12	15.2 mm	102.0 mm	32.0 mm	12.5 mm	10.00 mm
E011/BSW9/16M	€ 20,20	9/16" x 12	16.8 mm	102.0 mm	32.0 mm	12.5 mm	10.00 mm
E011/BSW5/8M	€ 24,80	5/8" x 11	18.6 mm	112.0 mm	37.0 mm	14.0 mm	11.20 mm
E011/BSW3/4M	€ 30,00	3/4" x 10	22.0 mm	118.0 mm	38.0 mm	16.0 mm	12.50 mm
E011/BSW7/8M	€ 40,50	7/8" x 9	25.5 mm	130.0 mm	45.0 mm	18.0 mm	14.00 mm
E011/BSW1M	€ 40,50	1" x 8	29.1 mm	138.0 mm	48.0 mm	20.0 mm	16.0 mm

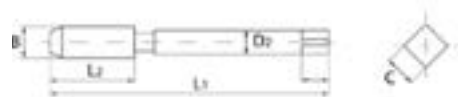

E011-BSFXM

MASCHI BSF STI PER F-COIL

Tipo speciale per creazione sede alloggiamento inserto filettato



Art.	€	Misura	B	L1	L2	D2	C
E011/BSF3/16M	€ 9,60	3/16" x 32	5.7 mm	66.0 mm	19.0 mm	6.3 mm	5.00 mm
E011/BSF1/4M	€ 9,60	1/4" x 26	7.5 mm	72.0 mm	22.0 mm	8.0 mm	6.30 mm
E011/BSF5/16M	€ 10,40	5/16" x 22	9.3 mm	80.0 mm	24.0 mm	10.0 mm	8.00 mm
E011/BSF3/8M	€ 11,20	3/8" x 20	11.0 mm	85.0 mm	25.0 mm	8.0 mm	6.30 mm
E011/BSF7/16M	€ 12,10	7/16" x 18	12.8 mm	89.0 mm	29.0 mm	9.0 mm	7.10 mm
E011/BSF1/2M	€ 13,40	1/2" x 16	14.6 mm	95.0 mm	30.0 mm	11.2 mm	9.00 mm
E011/BSF9/16M	€ 20,20	9/16" x 16	16.2 mm	102.0 mm	32.0 mm	12.5 mm	10.00 mm
E011/BSF5/8M	€ 24,80	5/8" x 14	18.0 mm	112.0 mm	37.0 mm	14.0 mm	11.20 mm
E011/BSF3/4M	€ 30,00	3/4" x 12	21.5 mm	118.0 mm	38.0 mm	16.0 mm	12.5 mm
E011/BSF7/8M	€ 40,50	7/8" x 11	24.9 mm	130.0 mm	45.0 mm	18.0 mm	14.00 mm
E011/BSF1M	€ 40,50	1" x 10	28.4 mm	138.0 mm	48.0 mm	20.0 mm	16.00 mm

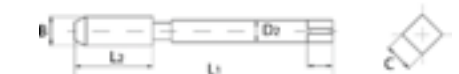

E011-BSPXM
COPPIA MASCHI BSP STI PER F-COIL

Tipo speciale per creazione sede alloggiamento inserto filettato

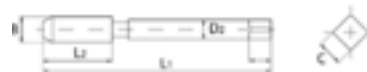

Art.	€	Misura	B	L1	L2	D2	C
E011/BSP1/8M	€ 25,00	1/8" x 28	10.8 mm	59 mm	15 mm	8.0 mm	6.3 mm
E011/BSP1/4M	€ 25,90	1/4" x 19	14.7 mm	67 mm	19 mm	11.2 mm	9.0 mm
E011/BSP3/8M	€ 33,70	3/8" x 19	18.3 mm	75 mm	21 mm	14.0 mm	11.2 mm
E011/BSP1/2M	€ 52,70	1/2" x 14	23.1 mm	87 mm	26 mm	16.0 mm	12.5 mm
E011/BSP5/8M	€ 74,30	5/8" x 14	25.1 mm	91 mm	26 mm	18.0 mm	14.0 mm
E011/BSP3/4M	€ 74,30	3/4" x 14	28.6 mm	96 mm	28 mm	20.0 mm	16.0 mm
E011/BSP7/8M	€ 117,00	7/8" x 14	32.4 mm	102 mm	29 mm	22.4 mm	18.0 mm
E011/BSP1M	€ 117,00	1" x 11	36.0 mm	109 mm	33 mm	25.0 mm	20.0 mm

E011-UNCXM
MASCHI UNC STI PER F-COIL

Tipo speciale per creazione sede alloggiamento inserto filettato

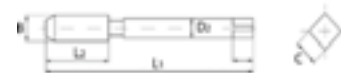

Art.	€	Misura	B	L1	L2	D2	C
E011/UNCN02M	€ 11,10	No. 2 x 56	2.8 mm	48.0 mm	10.0 mm	3.15 mm	2.5 mm
E011/UNCN04M	€ 11,10	No. 4 x 40	3.7 mm	53.0 mm	13.0 mm	4.0 mm	3.15 mm
E011/UNCN05M	€ 11,10	No. 5 x 40	4.0 mm	53.0 mm	13.0 mm	4.0 mm	3.15 mm
E011/UNCN06M	€ 11,10	No. 6 x 32	4.5 mm	58.0 mm	16.0 mm	5.0 mm	4.00 mm
E011/UNCN08M	€ 11,10	No. 8 x 32	5.2 mm	62.0 mm	17.0 mm	5.6 mm	4.50 mm
E011/UNCN10M	€ 11,10	No. 10 x 24	6.2 mm	66.0 mm	19.0 mm	6.3 mm	5.00 mm
E011/UNCN12M	€ 11,10	No. 12 x 24	6.9 mm	66.0 mm	19.0 mm	7.1 mm	5.60 mm
E011/UNC1/4M	€ 9,60	1/4" x 20	8.0 mm	72.0 mm	22.0 mm	8.0 mm	6.30 mm
E011/UNC5/16M	€ 10,40	5/16" x 18	9.8 mm	80.0 mm	24.0 mm	10.0 mm	8.00 mm
E011/UNC3/8M	€ 11,20	3/8" x 16	11.6 mm	85.0 mm	25.0 mm	8.0 mm	6.30 mm
E011/UNC7/16M	€ 12,10	7/16" x 14	13.5 mm	95.0 mm	30.0 mm	11.2 mm	10.00 mm
E011/UNC1/2M	€ 13,40	1/2" x 13	15.2 mm	102.0 mm	32.0 mm	12.5 mm	10.00 mm
E011/UNC9/16M	€ 20,20	9/16" x 12	17.0 mm	112.0 mm	37.0 mm	14.0 mm	11.20 mm
E011/UNC5/8M	€ 24,80	5/8" x 11	18.9 mm	112.0 mm	37.0 mm	14.0 mm	11.20 mm
E011/UNC3/4M	€ 30,00	3/4" x 10	22.4 mm	118.0 mm	38.0 mm	16.0 mm	12.50 mm
E011/UNC7/8M	€ 40,50	7/8" x 9	25.9 mm	130.0 mm	45.0 mm	18.0 mm	14.00 mm
E011/UNC1M	€ 40,50	1" x 8	29.5 mm	138.0 mm	48.0 mm	20.0 mm	16.00 mm

E011-UNFXM
MASCHI UNF STI PER F-COIL

Tipo speciale per creazione sede alloggiamento inserto filettato



Art.	€	Misura	B	L1	L2	D2	C
E011/UNFN04M	€ 12,10	No. 4 x 48	3.5 mm	53.0 mm	13.0 mm	4.0 mm	3.15 mm
E011/UNFN06M	€ 12,10	No. 6 x 40	4.3 mm	53.0 mm	13.0 mm	4.5 mm	3.55 mm
E011/UNFN08M	€ 12,10	No. 8 x 36	5.1 mm	62.0 mm	17.0 mm	5.6 mm	4.50 mm
E011/UNFN10M	€ 12,10	No. 10 x 32	5.9 mm	66.0 mm	19.0 mm	6.3 mm	5.00 mm
E011/UNF1/4M	€ 9,60	1/4" x 28	7.5 mm	69.0 mm	19.0 mm	8.0 mm	6.30 mm
E011/UNF5/16M	€ 10,40	5/16" x 24	9.3 mm	76.0 mm	20.0 mm	10.0 mm	8.00 mm
E011/UNF3/8M	€ 11,20	3/8" x 24	10.9 mm	82.0 mm	22.0 mm	8.0 mm	6.3 mm
E011/UNF7/16M	€ 12,10	7/16" x 20	12.8 mm	84.0 mm	24.0 mm	9.0 mm	7.10 mm
E011/UNF1/2M	€ 13,40	1/2" x 20	14.4 mm	90.0 mm	25.0 mm	11.2 mm	9.00 mm
E011/UNF9/16M	€ 20,20	9/16" x 18	16.1 mm	104.0 mm	29.0 mm	12.5 mm	10.00 mm
E011/UNF5/8M	€ 24,80	5/8" x 18	17.7 mm	104.0 mm	29.0 mm	14.0 mm	11.20 mm
E011/UNF3/4M	€ 30,00	3/4" x 16	21.1 mm	104.0 mm	29.0 mm	14.0 mm	11.20 mm
E011/UNF7/8M	€ 40,50	7/8" x 14	24.6 mm	120.0 mm	35.0 mm	18.0 mm	14.00 mm
E011/UNF112M	€ 40,50	1" x 12	28.2 mm	127.0 mm	37.0 mm	20.0 mm	16.00 mm





E011-UX

UTENSILE MONTAGGIO F-COIL

Art.	€	Metrici	Pollici
E011/U02	€ 7,40	M 2 x 0.4 - M 2.2 x 0.45	UNC N02
E011/U03	€ 7,40	M 2.5 x 0.45	-
E011/U04	€ 7,40	M 3 x 0.5	UNC N05 - UNC/UNF N04 - BSW 1/8"
E011/U05	€ 7,40	M 3.5 x 0.6	UNC/UNF N06
E011/U06	€ 7,40	M 4 x 0.7	UNC/UNF N08
E011/U08	€ 7,40	M 5 x 0.8	UNF N10 - UNC N12 - BSF 3/16"
E011/U09	€ 7,40	M 6 x 1.0	UNC/UNF 1/4" - BSW/BSF 1/4"
E011/U10	€ 7,40	M 7 x 1.0	UNC/BSW 5/16"
E011/U11	€ 8,20	M 8 x 1.25 - M 8 x 1.0	UNF/BSF 5/16"
E011/U12	€ 12,50	M 9 x 1.25 - M 9 x 1.0	UNC/BSW 3/8"
E011/U13	€ 12,50	M 10 x 1.5 - M 10 x 1.0 - M 10 x 1.25	UNF/BSF 3/8"
E011/U14	€ 13,50	M 11 x 1.5	UNC/UNF 7/16" - BSW-BSF 7/16"
E011/U15	€ 13,50	M 12 x 1.75 - M 12 x 1.5 - M 12 x 1.25 - M 12 x 1.0	UNC/UNF 1/2" - BSW-BSF 1/2"
E011/U16	€ 15,40	M 14 x 2.0 - M 14 x 1.5	UNC/UNF 9/16" - BSW-BSF 9/16"
E011/U17	€ 15,40	M 14 x 1.25 - M 14 x 1.0	-
E011/U18	€ 16,80	M 16 x 2.0 - M 16 x 1.5	UNC/UNF 5/8" - BSW-BSF 5/8"
E011/U20	€ 16,80	M 18 x 2.5 - M 18 x 2.0 - M 18 x 1.5	UNC 3/4" - BSW-BSF 3/4"
E011/U21	€ 16,80	M 20 x 2.5 - M 20 x 2.0 - M 20 x 1.5	UNF 3/4"
E011/U22	€ 21,20	M 22 x 2.5 - M 22 x 2.0 - M 22 x 1.5	UNC/UNF 7/8" - BSW-BSF 7/8"
E011/U23	€ 21,20	M 24 x 3.0 - M 24 x 2.0 - M 24 x 1.5	UNC/UNF 1" - BSW-BSF 1"



E011-UMX

UTENSILE ESAGONALE MONTAGGIO F-COIL

Art.	€	Diametro	Attacco esagonale
E011/UM260X150	€ 25,00	M 26 x 1.5	1/2"
E011/UM270X150	€ 25,00	M 27 x 1.5	1/2"
E011/UM270X200	€ 25,00	M 27 x 2.0	1/2"
E011/UM270X300	€ 25,00	M 27 x 3.0	1/2"
E011/UM280X150	€ 25,00	M 28 x 1.5	1/2"
E011/UM300X150	€ 27,90	M 30 x 1.5	1/2"
E011/UM300X200	€ 27,90	M 30 x 2.0	1/2"
E011/UM300X350	€ 27,90	M 30 x 3.5	1/2"
E011/UM330X200	€ 34,60	M 33 x 2.0	1/2"
E011/UM330X350	€ 34,60	M 33 x 3.5	1/2"
E011/UM360X150	€ 34,60	M 36 x 1.5	1/2"
E011/UM360X200	€ 34,60	M 36 x 2.0	1/2"
E011/UM360X300	€ 34,60	M 36 x 3.0	1/2"
E011/UM360X400	€ 34,60	M 36 x 4.0	1/2"



E011-AX

ATTREZZO PER ROTTURA CODOLO F-COIL

Art.	€	Metrici	Pollici
E011/A02	€ 2,41	M 2 x 0.4 - M 2.2 x 0.45	UNC N02
E011/A03	€ 2,41	M 2.5 x 0.45	-
E011/A04	€ 2,41	M 3 x 0.5	UNC/UNF N04
E011/A05	€ 2,41	M 3.5 x 0.6	UNC/UNF N06
E011/A06	€ 2,41	M 4 x 0.7	UNC N10 - UNC/UNF N08 - BSF 3/16"
E011/A08	€ 2,41	M 5 x 0.8	UNF N10 - UNC N12 - BSF 3/16"
E011/A09	€ 2,41	M 6 x 1.0	UNC/UNF 1/4" - BSW/BSF 1/4"
E011/A11	€ 2,71	M 7 x 1.0 - M 8 x 1.0 - M 8 x 1.25	UNC/UNF 5/16" - BSW/BSF 5/16"
E011/A12	€ 2,71	M 9 x 1.0 - M 9 x 1.25	UNC 3/8" - BSW/BSF 3/8"
E011/A13	€ 2,71	M 10 x 1.5 - M 10 x 1.0 - M 10 x 1.25	UNF 3/8"
E011/A14	€ 3,27	M 11 x 1.5	UNC/UNF 7/16" - BSW/BSF 7/16"
E011/A15	€ 3,27	M 12 x 1.5 - M 12 x 1.0 - M 12 x 1.25 - M 12 x 1.75	UNC/UNF 1/2" - BSW/BSF 1/2"



E011-EX

ESTRATTORE F-COIL

Art.	€	Metrici	Pollici
E011/E2	€ 15,60	M 3 - M 10	3/16" - 3/8"
E011/E3	€ 19,00	M 11 - M 25	3/8" - 1"



LBX

LAME A NASTRO BIMETALLICHE PER METALLO

Saldate in lunghezza standard



Art.	€	Misure	Specifiche	Passo
LB01/1140	€ 17,10	1140 x 13 x 0.65 mm	T 8 / 12 Bi-Metal	Variabile
LB01/1325	€ 18,90	1325 x 13 x 0.65 mm	T 8 / 12 Bi-Metal	Variabile
LB01/1335	€ 19,10	1335 x 13 x 0.65 mm	T 8 / 12 Bi-Metal	Variabile
LB01/1435	€ 20,10	1435 x 13 x 0.65 mm	T 8 / 12 Bi-Metal	Variabile
LB01/1440	€ 20,10	1440 x 13 x 0.65 mm	T 8 / 12 Bi-Metal	Variabile
LB01/1638	€ 22,10	1638 x 13 x 0.65 mm	T 8 / 12 Bi-Metal	Variabile
LB01/1735	€ 23,20	1735 x 13 x 0.65 mm	T 8 / 12 Bi-Metal	Variabile
LB02/1140	€ 17,10	1140 x 13 x 0.65 mm	T 6 Bi-Metal	Fisso
LB02/1435	€ 20,10	1435 x 13 x 0.65 mm	T 6 Bi-Metal	Fisso
LB05/1735	€ 23,90	1735 x 13 x 0.9 mm	T 8 / 12 Bi-Metal	Variabile
LB07/2000	€ 28,00	2000 x 20 x 0.9 mm	T 8 / 12 Bi-Metal	Variabile
LB07/2080	€ 28,80	2080 x 20 x 0.9 mm	T 8 / 12 Bi-Metal	Variabile
LB07/2100	€ 29,00	2100 x 20 x 0.9 mm	T 8 / 12 Bi-Metal	Variabile
LB07/2140	€ 29,50	2140 x 20 x 0.9 mm	T 8 / 12 Bi-Metal	Variabile
LB07/2160	€ 29,80	2160 x 20 x 0.9 mm	T 8 / 12 Bi-Metal	Variabile
LB08/2000	€ 28,00	2000 x 20 x 0.9 mm	T 5 / 7 Bi-Metal	Variabile
LB08/2080	€ 28,80	2080 x 20 x 0.9 mm	T 5 / 7 Bi-Metal	Variabile
LB08/2100	€ 29,00	2100 x 20 x 0.9 mm	T 5 / 7 Bi-Metal	Variabile
LB08/2140	€ 29,50	2140 x 20 x 0.9 mm	T 5 / 7 Bi-Metal	Variabile
LB08/2160	€ 29,80	2160 x 20 x 0.9 mm	T 5 / 7 Bi-Metal	Variabile
LB09/2375	€ 32,10	2375 x 27 x 0.9 mm	T 8 / 11 Bi-Metal	Variabile
LB09/2450	€ 34,30	2450 x 27 x 0.9 mm	T 8 / 11 Bi-Metal	Variabile

Art.	€	Misure	Specifiche	Passo
LB09/2500	€ 35,60	2500 x 27 x 0.9 mm	T 8 / 11 Bi-Metal	Variabile
LB09/2750	€ 38,70	2750 x 27 x 0.9 mm	T 8 / 11 Bi-Metal	Variabile
LB09/2825	€ 39,60	2825 x 27 x 0.9 mm	T 8 / 11 Bi-Metal	Variabile
LB09/2845	€ 39,80	2845 x 27 x 0.9 mm	T 8 / 11 Bi-Metal	Variabile
LB09/2945	€ 41,00	2945 x 27 x 0.9 mm	T 8 / 11 Bi-Metal	Variabile
LB09/2950	€ 41,20	2950 x 27 x 0.9 mm	T 8 / 11 Bi-Metal	Variabile
LB09/3010	€ 41,90	3010 x 27 x 0.9 mm	T 8 / 11 Bi-Metal	Variabile
LB09/3100	€ 42,90	3100 x 27 x 0.9 mm	T 8 / 11 Bi-Metal	Variabile
LB09/3120	€ 43,30	3120 x 27 x 0.9 mm	T 8 / 11 Bi-Metal	Variabile
LB09/3150	€ 43,50	3150 x 27 x 0.9 mm	T 8 / 11 Bi-Metal	Variabile
LB10/2375	€ 32,10	2375 x 27 x 0.9 mm	T 5 / 7 Bi-Metal	Variabile
LB10/2450	€ 34,30	2450 x 27 x 0.9 mm	T 5 / 7 Bi-Metal	Variabile
LB10/2500	€ 35,60	2500 x 27 x 0.9 mm	T 5 / 7 Bi-Metal	Variabile
LB10/2750	€ 38,70	2750 x 27 x 0.9 mm	T 5 / 7 Bi-Metal	Variabile
LB10/2825	€ 39,60	2825 x 27 x 0.9 mm	T 5 / 7 Bi-Metal	Variabile
LB10/2845	€ 39,80	2845 x 27 x 0.9 mm	T 5 / 7 Bi-Metal	Variabile
LB10/2945	€ 41,00	2945 x 27 x 0.9 mm	T 5 / 7 Bi-Metal	Variabile
LB10/2950	€ 41,20	2950 x 27 x 0.9 mm	T 5 / 7 Bi-Metal	Variabile
LB10/3010	€ 41,90	3010 x 27 x 0.9 mm	T 5 / 7 Bi-Metal	Variabile
LB10/3100	€ 42,90	3100 x 27 x 0.9 mm	T 5 / 7 Bi-Metal	Variabile
LB10/3120	€ 43,30	3120 x 27 x 0.9 mm	T 5 / 7 Bi-Metal	Variabile
LB10/3150	€ 43,50	3150 x 27 x 0.9 mm	T 5 / 7 Bi-Metal	Variabile

07X

DISCHI PER LEGNO CON RIPORTO IN METALLO DURO

Dentatura alternata universale

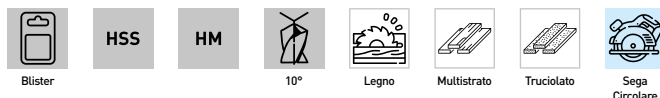

Art.	€	Ø	Denti Z	Foro	Spessore taglio	Spessore disco	Max rpm
0685	€ 29,40	254 mm	24	Ø 30 mm	3,2 mm	2,2 mm	6300
0702	€ 49,20	250 mm	60	Ø 30 mm	3,2 mm	2,2 mm	7000
0703	€ 56,70	250 mm	80	Ø 30 mm	3,2 mm	2,2 mm	7000
0704	€ 72,80	300 mm	72	Ø 30 mm	3,2 mm	2,2 mm	6000
0705	€ 78,60	300 mm	96	Ø 30 mm	3,2 mm	2,2 mm	6000
0899	€ 54,30	315 mm	25	Ø 30 mm	2,8 mm	1,8 mm	6000
0745	€ 89,20	350 mm	54	Ø 30 mm	3,5 mm	2,5 mm	5000
0707	€ 90,60	400 mm	48	Ø 30 mm	3,5 mm	2,5 mm	4500
0746	€ 156,00	450 mm	60	Ø 30 mm	4 mm	3,0 mm	4000

0762-

DISCO PER ALLUMINIO E MATERIALI PLASTICI CON RIPORTO IN METALLO DURO

Dentatura trapezoidale piatta con affilatura alternata



Art.	€	Ø	Denti Z	Foro	Spessore taglio	Spessore disco	Max rpm
0762/250	€ 58,10	250 mm	60	Ø 32 mm	3,2 mm	2,8 mm	7000
0762/300	€ 73,30	300 mm	72	Ø 32 mm	3,2 mm	2,8 mm	6000



N7X

LAMA PER LEGNO

Lama per taglio sagomato di legno sottile



Art.	€	Misure	Specifiche
N194	€ 23,20	1400 x 6 x 0,36 mm	T6
N717/N	€ 23,20	1430 x 6 x 0,36 mm	T6
N188	€ 27,40	1790 x 6 x 0,36 mm	T10
N190	€ 27,40	1826 x 6 x 0,36 mm	T10
N855/N2	€ 26,30	2240 x 13 x 0,65 mm	T8
N186	€ 23,50	2400 x 13 x 0,65 mm	T8
N192	€ 23,50	2560 x 13 x 0,65 mm	T8
N764/N2	€ 26,30	2950 x 13 x 0,65 mm	T6
N764/455/N2	€ 36,60	3430 x 16 x 0,65 mm	T6

N7X1

LAMA PER LEGNO

Lama per il taglio dritto di legno spesso



Art.	€	Misure	Specifiche
N195	€ 23,20	1400 x 10 x 0,36 mm	T6
N717/N1	€ 23,20	1430 x 10 x 0,36 mm	T6
N189	€ 27,40	1790 x 10 x 0,36 mm	T6
N191	€ 27,40	1826 x 10 x 0,36 mm	T6
N855/N	€ 26,30	2240 x 16 x 0,65 mm	T4
N187	€ 23,50	2400 x 16 x 0,65 mm	T4
N193	€ 23,50	2560 x 16 x 0,65 mm	T4
N764/N	€ 26,30	2950 x 16 x 0,65 mm	T4
N764/455/N	€ 36,60	3430 x 20 x 0,65 mm	T4







DISCHI LAMELLARI

- p. 244  Professional
- p. 250  Performance
- p. 254  Grindflex
- p. 258  Smartflex
- p. 261  Specialty
- p. 265  Fast Lock



RUOTE ABRASIVE

- p. 226  Ruote con gambo
- p. 267  Ruote con foro
- p. 268  Ruote per satinatrici



DISCHI E NASTRI ABRASIVI

- p. 271  Dischi in fibra
- p. 272  Dischi adesivi e velcrati
- p. 276  Rotoli e fogli
- p. 278  Nastri





PULITURA

- p. 281  Surface Conditioning
- p. 283  Nylon abrasivo
- p. 284  Non woven



FINITURA E LUCIDATURA

- p. 285  Feltro e paste abrasive
- p. 287  Sisal, cotone e lana
- p. 290  Spugne e gomme abrasive



MOLE E DISCHI DA TAGLIO

- p. 296  Dischi da taglio
- p. 300  Dischi da sbavo
- p. 302  Mole abrasive con foro
- p. 303  Mole abrasive con gambo
- p. 305  Dischi diamantati



SPAZZOLE A FILO

- p. 291  Spazzole con foro
- p. 293  Spazzole con gambo

RIFLEX, SPECIFICA ESPERIENZA

MADE IN ITALY

A partire dal 1982 Riflex si distingue sullo scenario internazionale per la specifica esperienza MADE IN ITALY sia nella produzione di dischi lamellari in corindone, zirconio e zirconio ceramicato con supporti sia in nylon che in fibra di vetro, sia nella realizzazione di impianti automatici per la loro produzione, testing e confezionamento.

Riflex supervisiona l'intera filiera produttiva attraverso rapporti decennali con i principali fornitori di materie prime (tela abrasiva, supporti e colla). L'esperienza ultra trentennale ha consentito di sviluppare proprie ricette e protocolli qualitativi ai massimi livelli nel mondo.



TELE ABRASIVE

		Zirconio Cotone peso X	Per acciai comuni, legati ed inossidabili. Supporto in cotone, ottima prestazione e durata. Questa tela è declinata in vari step di performance in base alle famiglie di prodotto.
		Corindone Cotone peso X	Per metalli e legno, per lavorazioni standard. Supporto in cotone. Questa tela è declinata in vari step di performance in base alle famiglie di prodotto.
SPECIALTY		Zircoceramico Polycotton	Studiato appositamente per la lavorazione di acciaio inossidabile. Terzo strato raffreddante, supporto in polycotton, alta velocità di taglio.
SPECIALTY		Ceramico Polycotton	Studiato appositamente per la lavorazione di acciaio inossidabile, per forti asportazioni. Terzo strato raffreddante, supporto in polycotton estremamente resistente, massima velocità di taglio.
SPECIALTY		Abranet® Rete in poliammide	Studiato appositamente per materiali intasanti come i metalli non ferrosi (alluminio, rame, ottone, zinco, magnesio), legno e materiali compositi. La particolare struttura a rete poliammidica impedisce la formazione di accumuli e intasamenti, assicurando grandi vantaggi: finiture impeccabili ed efficacia costante massimizzando il rendimento e riducendo i costi di lavorazione.

DISCHI LAMELLARI

FERVI BY RIFLEX



PROFESSIONAL

LA SCELTA DEGLI UTENTI PIÙ ESIGENTI

Disco professionale di lunga durata ed elevata velocità di asportazione per gli utenti più esigenti, realizzati esclusivamente con tela Norton™.

PERFORMANCE

LA PRESTAZIONE SENZA IL BLASONE

Ampia gamma di dischi lamellari professionali con tele in Zirconio e Ossido di Alluminio.



GRINDFLEX

IL DISCO PIÙ VERSATILE

Il "best seller", adatto per asportazioni massive e finitura e per lavorazioni su tutti i tipi di metalli, ferrosi e non ferrosi.

SMARTFLEX

VALUE FOR MONEY

Il miglior prezzo senza rinunciare alle prestazioni professionali. Per lavorazioni di asportazione e finitura.

SPECIALTY

PER LAVORAZIONI "SPECIALI"

Gamma di dischi per lavorazioni professionali su acciaio Inox, metalli non ferrosi (Alluminio, Rame, ecc.).

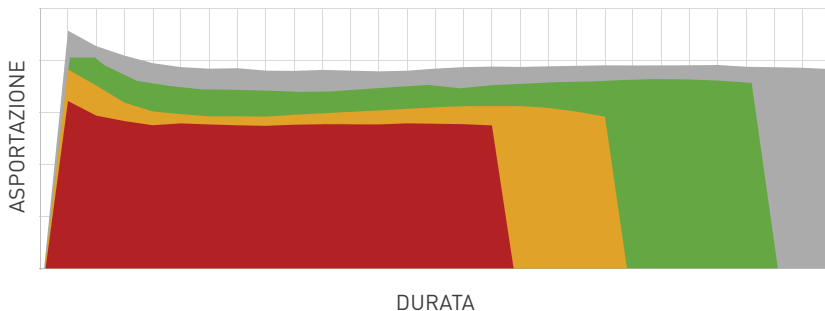

I nostri test sono effettuati con macchine Riflex usando un elettrotensile da 1200W con una pressione costante di 4 kg su un provino di test di acciaio S235JR (Fe360) con step da 2,5 min.

MODELLI

CLASSIC

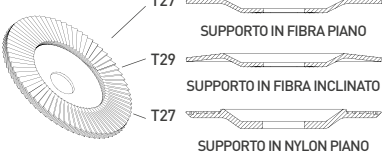

DUAL FLAP

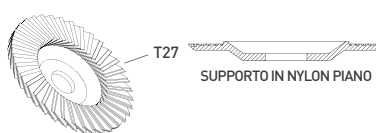

REAL FLAT

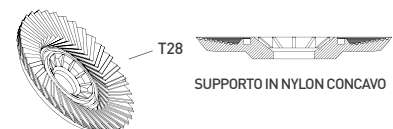

BIGGER

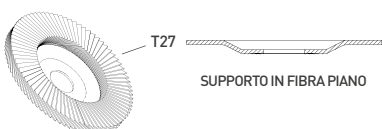

TIGER

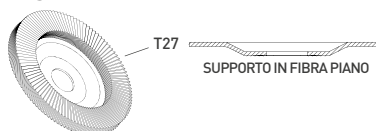

RAPTOR

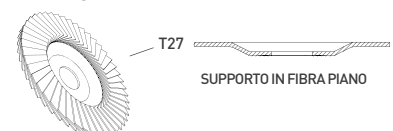



LA SCELTA DEGLI UTENTI PIÙ ESIGENTI

Disco professionale di lunga durata ed elevata velocità di asportazione per gli utenti più esigenti, realizzati esclusivamente con tela Norton™.

Per forti asportazioni, sbavature importanti – Pensato per utenti professionali e aziende di medie e grandi dimensioni. Ideale per lavorazioni su lamiere di grosse dimensioni, asportazione di grandi cordoni di saldatura e attività in cui si chiede lunga vita del disco.

DF8100-Z

DISCO LAMELLARE PROFESSIONAL CLASSIC



Art.	€	Dimensioni	Grana	Max rpm	Pack
DF8100.111	€ 2,31	115 x 22 mm	36	13300	10
DF8100.112	€ 2,31	115 x 22 mm	40	13300	10
DF8100.114	€ 2,31	115 x 22 mm	60	13300	10
DF8100.115	€ 2,31	115 x 22 mm	80	13300	10
DF8100.117	€ 2,31	115 x 22 mm	120	13300	10
DF8100.121	€ 2,89	125 x 22 mm	36	12250	10
DF8100.122	€ 2,89	125 x 22 mm	40	12250	10
DF8100.124	€ 2,89	125 x 22 mm	60	12250	10
DF8100.125	€ 2,89	125 x 22 mm	80	12250	10
DF8100.181	€ 4,80	180 x 22 mm	36	8500	10
DF8100.182	€ 4,80	180 x 22 mm	40	8500	10
DF8100.184	€ 4,80	180 x 22 mm	60	8500	10
DF8100.185	€ 4,80	180 x 22 mm	80	8500	10



DF8150-Z

DISCO LAMELLARE PROFESSIONAL CLASSIC



Art.	€	Dimensioni	Grana	Max rpm	Pack
DF8150.111	€ 2,31	115 x 22 mm	36	13300	10
DF8150.112	€ 2,31	115 x 22 mm	40	13300	10
DF8150.114	€ 2,31	115 x 22 mm	60	13300	10
DF8150.115	€ 2,31	115 x 22 mm	80	13300	10
DF8150.117	€ 2,31	115 x 22 mm	120	13300	10
DF8150.121	€ 2,89	125 x 22 mm	36	12250	10
DF8150.122	€ 2,89	125 x 22 mm	40	12250	10
DF8150.124	€ 2,89	125 x 22 mm	60	12250	10
DF8150.125	€ 2,89	125 x 22 mm	80	12250	10
DF8150.181	€ 4,80	180 x 22 mm	36	8500	10
DF8150.182	€ 4,80	180 x 22 mm	40	8500	10
DF8150.184	€ 4,80	180 x 22 mm	60	8500	10
DF8150.185	€ 4,80	180 x 22 mm	80	8500	10



**DN8100-Z****DISCO LAMELLARE PROFESSIONAL CLASSIC**

Art.	€	Dimensioni	Grana	Max rpm	Pack
DN8100.111	€ 2,31	115 x 22 mm	36	13300	10
DN8100.112	€ 2,31	115 x 22 mm	40	13300	10
DN8100.114	€ 2,31	115 x 22 mm	60	13300	10
DN8100.115	€ 2,31	115 x 22 mm	80	13300	10
DN8100.117	€ 2,31	115 x 22 mm	120	13300	10
DN8100.122	€ 2,89	125 x 22 mm	40	12250	10
DN8100.124	€ 2,89	125 x 22 mm	60	12250	10
DN8100.125	€ 2,89	125 x 22 mm	80	12250	10
DN8100.182	€ 4,80	180 x 22 mm	40	8500	10
DN8100.184	€ 4,80	180 x 22 mm	60	8500	10
DN8100.185	€ 4,80	180 x 22 mm	80	8500	10

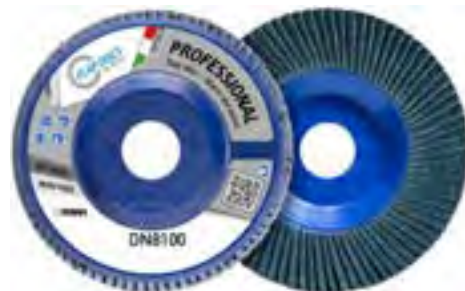
**DN8300-Z****DISCO LAMELLARE PROFESSIONAL DUAL FLAP**

Art.	€	Dimensioni	Grana	Max rpm	Pack
DN8300.111	€ 2,31	115 x 22 mm	36	13300	10
DN8300.112	€ 2,31	115 x 22 mm	40	13300	10
DN8300.114	€ 2,31	115 x 22 mm	60	13300	10
DN8300.115	€ 2,31	115 x 22 mm	80	13300	10
DN8300.117	€ 2,31	115 x 22 mm	120	13300	10
DN8300.122	€ 2,89	125 x 22 mm	40	12250	10
DN8300.124	€ 2,89	125 x 22 mm	60	12250	10
DN8300.125	€ 2,89	125 x 22 mm	80	12250	10
DN8300.182	€ 4,80	180 x 22 mm	40	8500	10
DN8300.184	€ 4,80	180 x 22 mm	60	8500	10
DN8300.185	€ 4,80	180 x 22 mm	80	8500	10

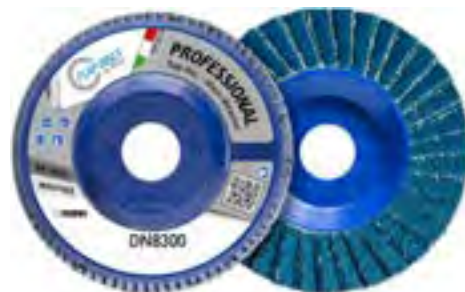
**DN8550-Z****DISCO LAMELLARE PROFESSIONAL REAL FLAT**

Questi dischi lamellari sono fabbricati con uno speciale supporto di forma convessa grazie al quale si ottiene un disco perfettamente piano con lamelle larghe e con densità e durezza costante sia al centro che sul diametro esterno.



Art.	€	Dimensioni	Grana	Max rpm	Pack
DN8550.112	€ 3,36	115 x 22 mm	40	13300	10
DN8550.114	€ 3,36	115 x 22 mm	60	13300	10
DN8550.115	€ 3,36	115 x 22 mm	80	13300	10
DN8550.117	€ 3,36	115 x 22 mm	120	13300	10



DF8600-Z
DISCO LAMELLARE PROFESSIONAL BIGGER

Con il disco lamellare bigger si smeriglia più a lungo, più velocemente, ottenendo una miglior finitura. La nuova struttura assicura migliori risultati se comparati ai dischi lamellari convenzionali o ad altri dischi abrasivi: 50% in più nella capacità di asportazione, con riduzione dei tempi di lavoro, doppia durata, ottimo rapporto qualità prezzo, taglio più freddo, riduzione dei tempi e dei costi.



Art.	€	Dimensioni	Grana	Max rpm	Pack
DF8600.112	€ 2,79	115 x 22 mm	40	13300	10
DF8600.114	€ 2,79	115 x 22 mm	60	13300	10
DF8600.115	€ 2,79	115 x 22 mm	80	13300	10
DF8600.117	€ 2,79	115 x 22 mm	120	13300	10
DF8600.122	€ 3,27	125 x 22 mm	40	12250	10
DF8600.124	€ 3,27	125 x 22 mm	60	12250	10
DF8600.125	€ 3,27	125 x 22 mm	80	12250	10
DF8600.127	€ 3,27	125 x 22 mm	120	12250	10
DF8600.182	€ 5,70	180 x 22 mm	40	8500	10
DF8600.184	€ 5,70	180 x 22 mm	60	8500	10
DF8600.185	€ 5,70	180 x 22 mm	80	8500	10
DF8600.187	€ 5,70	180 x 22 mm	120	8500	10

DF8700-Z
DISCO LAMELLARE PROFESSIONAL TIGER

Tiger è un disco lamellare con il 70% in più di tela abrasiva rispetto ai dischi professionali standard. La sua forma permette l'utilizzo completo della parte abrasiva oltre a renderlo particolarmente compatto. Questa caratteristica abbinata al supporto rinforzato, permette di esercitare una pressione specifica superiore e di conseguenza una asportazione più rapida.



Art.	€	Dimensioni	Grana	Max rpm	Pack
DF8700.112	€ 2,89	115 x 22 mm	40	13300	10
DF8700.114	€ 2,89	115 x 22 mm	60	13300	10
DF8700.115	€ 2,89	115 x 22 mm	80	13300	10
DF8700.117	€ 2,89	115 x 22 mm	120	13300	10



**DF8100-A****DISCO LAMELLARE PROFESSIONAL CLASSIC**

Art.	€	Dimensioni	Grana	Max rpm	Pack
DF8100.212	€ 2,21	115 x 22 mm	40	13300	10
DF8100.214	€ 2,21	115 x 22 mm	60	13300	10
DF8100.215	€ 2,21	115 x 22 mm	80	13300	10

**DF8150-A****DISCO LAMELLARE PROFESSIONAL CLASSIC**

Art.	€	Dimensioni	Grana	Max rpm	Pack
DF8150.212	€ 2,21	115 x 22 mm	40	13300	10
DF8150.214	€ 2,21	115 x 22 mm	60	13300	10
DF8150.215	€ 2,21	115 x 22 mm	80	13300	10

**DN8100-A****DISCO LAMELLARE PROFESSIONAL CLASSIC**

Art.	€	Dimensioni	Grana	Max rpm	Pack
DN8100.212	€ 2,21	115 x 22 mm	40	13300	10
DN8100.214	€ 2,21	115 x 22 mm	60	13300	10
DN8100.215	€ 2,21	115 x 22 mm	80	13300	10

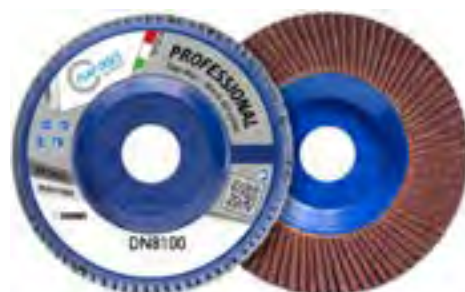
**DN8300-A****DISCO LAMELLARE PROFESSIONAL DUAL FLAP**

Art.	€	Dimensioni	Grana	Max rpm	Pack
DN8300.212	€ 2,21	115 x 22 mm	40	13300	10
DN8300.214	€ 2,21	115 x 22 mm	60	13300	10
DN8300.215	€ 2,21	115 x 22 mm	80	13300	10



PERFORMANCE

LA PRESTAZIONE SENZA IL BLASONE

Nuova gamma di dischi lamellari con tele in Zirconio e Ossido di Alluminio ad alte prestazioni.

Per produzioni massive e dove si richiede alta capacità di asportazione - Pensato per aziende di medie e grosse dimensioni. Ideale per utenti esigenti e per usi gravosi e lavorazioni in cui si richiede lunga vita del disco.

DF6100-Z

DISCO LAMELLARE PERFORMANCE CLASSIC



Art.	€	Dimensioni	Grana	Max rpm	Pack
DF6100.112	€ 2,12	115 x 22 mm	40	13300	10
DF6100.114	€ 2,12	115 x 22 mm	60	13300	10
DF6100.115	€ 2,12	115 x 22 mm	80	13300	10
DF6100.117	€ 2,12	115 x 22 mm	120	13300	10
DF6100.122	€ 2,60	125 x 22 mm	40	12250	10
DF6100.124	€ 2,60	125 x 22 mm	60	12250	10
DF6100.125	€ 2,60	125 x 22 mm	80	12250	10
DF6100.182	€ 4,32	180 x 22 mm	40	8500	10
DF6100.184	€ 4,32	180 x 22 mm	60	8500	10
DF6100.185	€ 4,32	180 x 22 mm	80	8500	10



DF6150-Z

DISCO LAMELLARE PERFORMANCE CLASSIC



Art.	€	Dimensioni	Grana	Max rpm	Pack
DF6150.112	€ 2,12	115 x 22 mm	40	13300	10
DF6150.114	€ 2,12	115 x 22 mm	60	13300	10
DF6150.115	€ 2,12	115 x 22 mm	80	13300	10
DF6150.117	€ 2,12	115 x 22 mm	120	13300	10
DF6150.122	€ 2,60	125 x 22 mm	40	12250	10
DF6150.124	€ 2,60	125 x 22 mm	60	12250	10
DF6150.125	€ 2,60	125 x 22 mm	80	12250	10
DF6150.182	€ 4,32	180 x 22 mm	40	8500	10
DF6150.184	€ 4,32	180 x 22 mm	60	8500	10
DF6150.185	€ 4,32	180 x 22 mm	80	8500	10





DN6100-Z

DISCO LAMELLARE PERFORMANCE CLASSIC

Zr Nylon T27 Singola EN 13743 Sgross. Acciaio Inox Ghisa Prep. Superficie 0-15° Smerigl. angolare Made In RIFLEX

Art.	€	Dimensioni	Grana	Max rpm	Pack
DN6100.112	€ 2,12	115 x 22 mm	40	13300	10
DN6100.114	€ 2,12	115 x 22 mm	60	13300	10
DN6100.115	€ 2,12	115 x 22 mm	80	13300	10
DN6100.117	€ 2,12	115 x 22 mm	120	13300	10
DN6100.122	€ 2,60	125 x 22 mm	40	12250	10
DN6100.124	€ 2,60	125 x 22 mm	60	12250	10
DN6100.125	€ 2,60	125 x 22 mm	80	12250	10
DN6100.182	€ 4,32	180 x 22 mm	40	8500	10
DN6100.184	€ 4,32	180 x 22 mm	60	8500	10
DN6100.185	€ 4,32	180 x 22 mm	80	8500	10

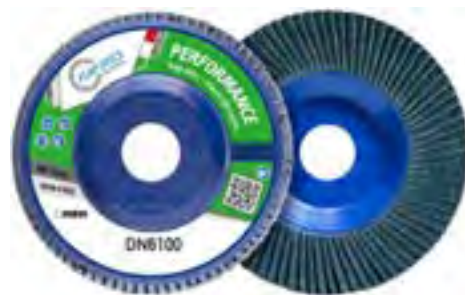

DN6300-Z

DISCO LAMELLARE PERFORMANCE DUAL FLAP

Zr Nylon T27 Doppia EN 13743 Sgross. Acciaio Inox Ghisa Prep. Superficie 0-15° Smerigl. angolare Made In RIFLEX

Art.	€	Dimensioni	Grana	Max rpm	Pack
DN6300.112	€ 2,12	115 x 22 mm	40	13300	10
DN6300.114	€ 2,12	115 x 22 mm	60	13300	10
DN6300.115	€ 2,12	115 x 22 mm	80	13300	10
DN6300.117	€ 2,12	115 x 22 mm	120	13300	10
DN6300.122	€ 2,60	125 x 22 mm	40	12250	10
DN6300.124	€ 2,60	125 x 22 mm	60	12250	10
DN6300.125	€ 2,60	125 x 22 mm	80	12250	10
DN6300.182	€ 4,32	180 x 22 mm	40	8500	10
DN6300.184	€ 4,32	180 x 22 mm	60	8500	10
DN6300.185	€ 4,32	180 x 22 mm	80	8500	10

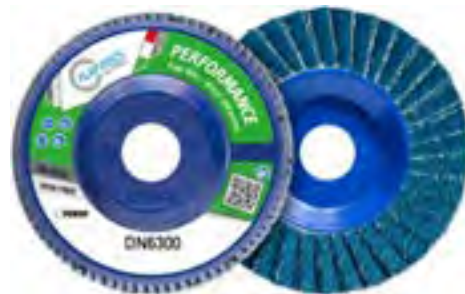

DN6550-Z

DISCO LAMELLARE PERFORMANCE REAL FLAT

Questi dischi lamellari sono fabbricati con uno speciale supporto di forma convessa grazie al quale si ottiene un disco perfettamente piano con lamelle larghe e con densità e durezza costante sia al centro che sul diametro esterno.

Zr Nylon T28 Doppia EN 13743 Sgross. Acciaio Inox Ghisa Prep. Superficie 0-15° Smerigl. angolare Made In RIFLEX

Art.	€	Dimensioni	Grana	Max rpm	Pack
DN6550.112	€ 2,89	115 x 22 mm	40	13300	10
DN6550.114	€ 2,89	115 x 22 mm	60	13300	10
DN6550.115	€ 2,89	115 x 22 mm	80	13300	10
DN6550.117	€ 2,89	115 x 22 mm	120	13300	10



DF6600-Z

DISCO LAMELLARE PERFORMANCE BIGGER

Con il disco lamellare bigger si smeriglia più a lungo, più velocemente, ottenendo una miglior finitura. la nuova struttura assicura migliori risultati se comparati ai dischi lamellari convenzionali o ad altri dischi abrasivi: 50% in più nella capacità di asportazione, con riduzione dei tempi di lavoro; doppia durata; ottimo rapporto qualità prezzo; taglio più freddo; riduzione dei tempi e dei costi.

Zr T27 EN 13743 Made in REFLEX

Art.	€	Dimensioni	Grana	Max rpm	Pack
DF6600.112	€ 2,60	115 x 22 mm	40	13300	10
DF6600.114	€ 2,60	115 x 22 mm	60	13300	10
DF6600.115	€ 2,60	115 x 22 mm	80	13300	10
DF6600.117	€ 2,60	115 x 22 mm	120	13300	10
DF6600.122	€ 2,98	125 x 22 mm	40	12250	10
DF6600.124	€ 2,98	125 x 22 mm	60	12250	10
DF6600.125	€ 2,98	125 x 22 mm	80	12250	10
DF6600.127	€ 2,98	125 x 22 mm	120	12250	10
DF6600.182	€ 5,30	180 x 22 mm	40	8500	10
DF6600.184	€ 5,30	180 x 22 mm	60	8500	10



DF6700-Z

DISCO LAMELLARE PERFORMANCE TIGER

Tiger è un disco lamellare con il 70% in più di tela abrasiva rispetto ai dischi professionali standard. la sua forma permette l'utilizzo completo della parte abrasiva oltre a renderlo particolarmente compatto. questa caratteristica abbinata al supporto rinforzato, permette di esercitare una pressione specifica superiore e di conseguenza una asportazione più rapida.

Zr T27 EN 13743 Made in REFLEX

Art.	€	Dimensioni	Grana	Max rpm	Pack
DF6700.112	€ 2,50	115 x 22 mm	40	13300	10
DF6700.114	€ 2,50	115 x 22 mm	60	13300	10
DF6700.115	€ 2,50	115 x 22 mm	80	13300	10
DF6700.117	€ 2,50	115 x 22 mm	120	13300	10





DF6100-A

DISCO LAMELLARE PERFORMANCE CLASSIC



Art.	€	Dimensioni	Grana	Max rpm	Pack
DF6100.212	€ 2,02	115 x 22 mm	40	13300	10
DF6100.214	€ 2,02	115 x 22 mm	60	13300	10
DF6100.215	€ 2,02	115 x 22 mm	80	13300	10



DF6150-A

DISCO LAMELLARE PERFORMANCE CLASSIC



Art.	€	Dimensioni	Grana	Max rpm	Pack
DF6150.212	€ 2,02	115 x 22 mm	40	13300	10
DF6150.214	€ 2,02	115 x 22 mm	60	13300	10
DF6150.215	€ 2,02	115 x 22 mm	80	13300	10



DN6100-A

DISCO LAMELLARE PERFORMANCE CLASSIC



Art.	€	Dimensioni	Grana	Max rpm	Pack
DN6100.212	€ 2,02	115 x 22 mm	40	13300	10
DN6100.214	€ 2,02	115 x 22 mm	60	13300	10
DN6100.215	€ 2,02	115 x 22 mm	80	13300	10



DN6300-A

DISCO LAMELLARE PERFORMANCE DUAL FLAP



Art.	€	Dimensioni	Grana	Max rpm	Pack
DN6300.212	€ 2,02	115 x 22 mm	40	13300	10
DN6300.214	€ 2,02	115 x 22 mm	60	13300	10
DN6300.215	€ 2,02	115 x 22 mm	80	13300	10





IL DISCO PIÙ VERSATILE

Il “best seller”, adatto per asportazioni massive e finitura e per lavorazioni su tutti i tipi di metalli, ferrosi e non ferrosi.

Per usi specifici, produzioni massive e finitura - Pensato per artigiani, grandi e medie industrie. Ideale per asportazione di cordoni di saldatura e lavorazioni in cui si richiede lunga durata del disco, oltre a sbavatura di lamiera.

DF4100-Z

DISCO LAMELLARE GRINDFLEX CLASSIC

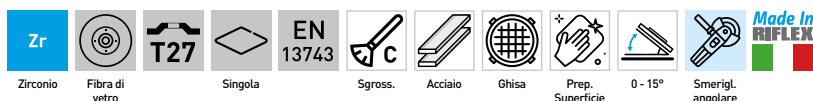

Art.	€	Dimensioni	Grana	Max rpm	Pack
DF4100.112	€ 1,93	115 x 22 mm	40	13300	10
DF4100.114	€ 1,93	115 x 22 mm	60	13300	10
DF4100.115	€ 1,93	115 x 22 mm	80	13300	10
DF4100.117	€ 1,93	115 x 22 mm	120	13300	10
DF4100.122	€ 2,31	125 x 22 mm	40	12250	10
DF4100.124	€ 2,31	125 x 22 mm	60	12250	10
DF4100.125	€ 2,31	125 x 22 mm	80	12250	10
DF4100.127	€ 2,31	125 x 22 mm	120	12250	10
DF4100.182	€ 3,84	180 x 22 mm	40	8500	10
DF4100.184	€ 3,84	180 x 22 mm	60	8500	10
DF4100.185	€ 3,84	180 x 22 mm	80	8500	10
DF4100.187	€ 3,84	180 x 22 mm	120	8500	10



DF4150-Z

DISCO LAMELLARE GRINDFLEX CLASSIC

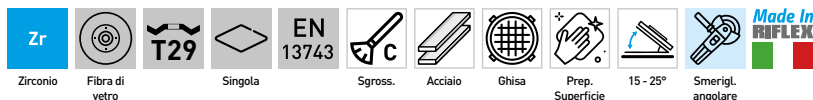

Art.	€	Dimensioni	Grana	Max rpm	Pack
DF4150.112	€ 1,93	115 x 22 mm	40	13300	10
DF4150.114	€ 1,93	115 x 22 mm	60	13300	10
DF4150.115	€ 1,93	115 x 22 mm	80	13300	10
DF4150.117	€ 1,93	115 x 22 mm	120	13300	10
DF4150.122	€ 2,31	125 x 22 mm	40	12250	10
DF4150.124	€ 2,31	125 x 22 mm	60	12250	10
DF4150.125	€ 2,31	125 x 22 mm	80	12250	10
DF4150.127	€ 2,31	125 x 22 mm	120	12250	10
DF4150.182	€ 3,84	180 x 22 mm	40	8500	10
DF4150.184	€ 3,84	180 x 22 mm	60	8500	10
DF4150.185	€ 3,84	180 x 22 mm	80	8500	10
DF4150.187	€ 3,84	180 x 22 mm	120	8500	10



**DN4100-Z****DISCO LAMELLARE GRINDFLEX CLASSIC**

Art.	€	Dimensioni	Grana	Max rpm	Pack
DN4100.112	€ 1,93	115 x 22 mm	40	13300	10
DN4100.114	€ 1,93	115 x 22 mm	60	13300	10
DN4100.115	€ 1,93	115 x 22 mm	80	13300	10
DN4100.122	€ 2,41	125 x 22 mm	40	12250	10
DN4100.124	€ 2,41	125 x 22 mm	60	12250	10

**DN4300-Z****DISCO LAMELLARE GRINDFLEX DUAL FLAP**

Art.	€	Dimensioni	Grana	Max rpm	Pack
DN4300.112	€ 1,93	115 x 22 mm	40	13300	10
DN4300.114	€ 1,93	115 x 22 mm	60	13300	10
DN4300.115	€ 1,93	115 x 22 mm	80	13300	10
DN4300.117	€ 1,93	115 x 22 mm	120	13300	10

**DN4550-Z****DISCO LAMELLARE GRINDFLEX REAL FLAT**

Questi dischi lamellari sono fabbricati con uno speciale supporto di forma convessa grazie al quale si ottiene un disco perfettamente piano con lamelle larghe e con densità e durezza costante sia al centro che sul diametro esterno.



Art.	€	Dimensioni	Grana	Max rpm	Pack
DN4550.112	€ 2,69	115 x 22 mm	40	13300	10
DN4550.114	€ 2,69	115 x 22 mm	60	13300	10



DF4600-Z

DISCO LAMELLARE GRINDFLEX BIGGER

Con il disco lamellare bigger si smeriglia più a lungo, più velocemente, ottenendo una miglior finitura. La nuova struttura assicura migliori risultati se comparati ai dischi lamellari convenzionali o ad altri dischi abrasivi: 50% in più nella capacità di asportazione, con riduzione dei tempi di lavoro, doppia durata, ottimo rapporto qualità prezzo, taglio più freddo, riduzione dei tempi e dei costi.

Zirconio	Fibra di vetro	T27	Singola	EN 13743	Sgross.	Acciaio	Ghisa	Prep. Superficie	0 - 15°	Smerigl. angolare	Made in REFLEX

Art.	€	Dimensioni	Grana	Max rpm	Pack
DF4600.112	€ 2,41	115 x 22 mm	40	13300	10
DF4600.114	€ 2,41	115 x 22 mm	60	13300	10
DF4600.115	€ 2,41	115 x 22 mm	80	13300	10
DF4600.117	€ 2,41	115 x 22 mm	120	13300	10
DF4600.122	€ 2,69	125 x 22 mm	40	12250	10
DF4600.124	€ 2,69	125 x 22 mm	60	12250	10
DF4600.182	€ 4,80	180 x 22 mm	40	8500	10
DF4600.184	€ 4,80	180 x 22 mm	60	8500	10





DF4100-A

DISCO LAMELLARE GRINDFLEX CLASSIC



Art.	€	Dimensioni	Grana	Max rpm	Pack
DF4100.212	€ 1,74	115 x 22 mm	40	13300	10
DF4100.214	€ 1,74	115 x 22 mm	60	13300	10
DF4100.215	€ 1,74	115 x 22 mm	80	13300	10



DF4150-A

DISCO LAMELLARE GRINDFLEX CLASSIC



Art.	€	Dimensioni	Grana	Max rpm	Pack
DF4150.212	€ 1,74	115 x 22 mm	40	13300	10
DF4150.214	€ 1,74	115 x 22 mm	60	13300	10
DF4150.215	€ 1,74	115 x 22 mm	80	13300	10



DN4100-A

DISCO LAMELLARE GRINDFLEX CLASSIC



Art.	€	Dimensioni	Grana	Max rpm	Pack
DN4100.212	€ 1,83	115 x 22 mm	40	13300	10
DN4100.214	€ 1,83	115 x 22 mm	60	13300	10



DN4300-A

DISCO LAMELLARE GRINDFLEX DUAL FLAP



Art.	€	Dimensioni	Grana	Max rpm	Pack
DN4300.212	€ 1,74	115 x 22 mm	40	13300	10
DN4300.214	€ 1,74	115 x 22 mm	60	13300	10
DN4300.215	€ 1,74	115 x 22 mm	80	13300	10



SMARTFLEX

VALUE FOR MONEY

Il miglior prezzo senza rinunciare alle prestazioni professionali. Per lavorazioni di asportazione e finitura.

Per usi comuni e basse produzioni - Pensato per hobbisti, cantieristica e piccoli artigiani (imprese individuali), che non vogliono rinunciare alle prestazioni. Ideale per asportazione di cordoni di saldatura, sbavatura di lamiere e finitura

DF2100-Z

DISCO LAMELLARE SMARTFLEX CLASSIC

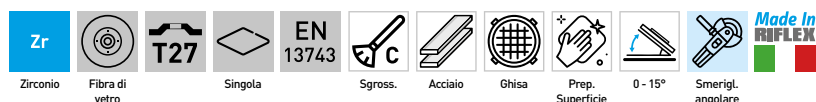

Art.	€	Dimensioni	Grana	Max rpm	Pack
DF2100.112	€ 1,74	115 x 22 mm	40	13300	10
DF2100.114	€ 1,74	115 x 22 mm	60	13300	10
DF2100.115	€ 1,74	115 x 22 mm	80	13300	10
DF2100.117	€ 1,74	115 x 22 mm	120	13300	10
DF2100.122	€ 2,12	125 x 22 mm	40	12250	10
DF2100.124	€ 2,12	125 x 22 mm	60	12250	10
DF2100.125	€ 2,12	125 x 22 mm	80	12250	10
DF2100.127	€ 2,12	125 x 22 mm	120	12250	10



DF2150-Z

DISCO LAMELLARE SMARTFLEX CLASSIC



Art.	€	Dimensioni	Grana	Max rpm	Pack
DF2150.112	€ 1,74	115 x 22 mm	40	13300	10
DF2150.114	€ 1,74	115 x 22 mm	60	13300	10
DF2150.115	€ 1,74	115 x 22 mm	80	13300	10
DF2150.117	€ 1,74	115 x 22 mm	120	13300	10
DF2150.122	€ 2,12	125 x 22 mm	40	12250	10
DF2150.124	€ 2,12	125 x 22 mm	60	12250	10
DF2150.125	€ 2,12	125 x 22 mm	80	12250	10
DF2150.127	€ 2,12	125 x 22 mm	120	12250	10



DN2100-Z

DISCO LAMELLARE SMARTFLEX CLASSIC

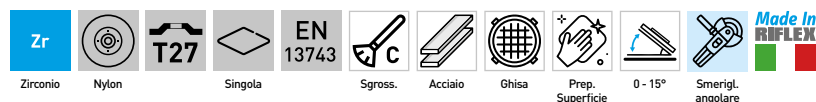

Art.	€	Dimensioni	Grana	Max rpm	Pack
DN2100.112	€ 1,74	115 x 22 mm	40	13300	10
DN2100.114	€ 1,74	115 x 22 mm	60	13300	10
DN2100.115	€ 1,74	115 x 22 mm	80	13300	10
DN2100.117	€ 1,74	115 x 22 mm	120	13300	10
DN2100.122	€ 2,12	125 x 22 mm	40	12250	10
DN2100.124	€ 2,12	125 x 22 mm	60	12250	10
DN2100.125	€ 2,12	125 x 22 mm	80	12250	10
DN2100.127	€ 2,12	125 x 22 mm	120	12250	10





DN2300-Z

DISCO LAMELLARE SMARTFLEX DUAL FLAP



Art.	€	Dimensioni	Grana	Max rpm	Pack
DN2300.112	€ 1,74	115 x 22 mm	40	13300	10
DN2300.114	€ 1,74	115 x 22 mm	60	13300	10
DN2300.115	€ 1,74	115 x 22 mm	80	13300	10
DN2300.117	€ 1,74	115 x 22 mm	120	13300	10
DN2300.122	€ 2,12	125 x 22 mm	40	12250	10
DN2300.124	€ 2,12	125 x 22 mm	60	12250	10
DN2300.125	€ 2,12	125 x 22 mm	80	12250	10
DN2300.127	€ 2,12	125 x 22 mm	120	12250	10



DF2100-A

DISCO LAMELLARE SMARTFLEX CLASSIC



Art.	€	Dimensioni	Grana	Max rpm	Pack
DF2100.212	€ 1,53	115 x 22 mm	40	13300	10
DF2100.214	€ 1,53	115 x 22 mm	60	13300	10
DF2100.215	€ 1,53	115 x 22 mm	80	13300	10



DF2150-A

DISCO LAMELLARE SMARTFLEX CLASSIC



Art.	€	Dimensioni	Grana	Max rpm	Pack
DF2150.212	€ 1,53	115 x 22 mm	40	13300	10
DF2150.214	€ 1,53	115 x 22 mm	60	13300	10
DF2150.215	€ 1,53	115 x 22 mm	80	13300	10



DN2100-A

DISCO LAMELLARE SMARTFLEX CLASSIC



Art.	€	Dimensioni	Grana	Max rpm	Pack
DN2100.212	€ 1,53	115 x 22 mm	40	13300	10
DN2100.214	€ 1,53	115 x 22 mm	60	13300	10
DN2100.215	€ 1,53	115 x 22 mm	80	13300	10



SPECIALTY INOX

Disco ideale per le lavorazioni di superfici in acciaio inossidabile, con tela zircoceramica con terzo strato refrigerante "top size".

Per applicazioni nei settori alimentare, farmaceutico e chimico. Pensato per gli specialisti dell'inox. Ideale per lavorazioni di lamiere sottili, importanti sbavature di cordoni di saldature e dove si richiede un prodotto che resista alla temperatura con elettrotensili da 1400w e oltre.

SPECIALTY INOX è un **disco lamellare** costituito da una tela abrasiva **"TOP SIZE"** con una miscela di **zirconio** e **abrasivo ceramico**. Questi materiali di elevata qualità consentono una **altissima velocità** di taglio assieme ad una **eccezionale durata** del disco. L'ulteriore strato **"TOP SIZE"** riduce drasticamente il surriscaldamento del disco e del pezzo da lavorare con **evidenti benefici nelle lavorazioni degli acciai inossidabili**. Il colore azzurro è per sua natura privo di ossidi di ferro in modo da prevenire la contaminazione degli acciai inossidabili ($\geq 0,1\%$ Fe, S, Cl)

DF9100-ZC

DISCO LAMELLARE ZIRCO CER CLASSIC



Art.	€	Dimensioni	Grana	Max rpm	Pack
DF9100.312	€ 3,08	115 x 22 mm	40+	13300	10
DF9100.314	€ 3,08	115 x 22 mm	60	13300	10
DF9100.322	€ 3,46	125 x 22 mm	40+	12250	10
DF9100.324	€ 3,46	125 x 22 mm	60	12250	10



DF9150-ZC

DISCO LAMELLARE ZIRCO CER CLASSIC



Art.	€	Dimensioni	Grana	Max rpm	Pack
DF9150.312	€ 3,08	115 x 22 mm	40+	13300	10
DF9150.314	€ 3,08	115 x 22 mm	60	13300	10
DF9150.322	€ 3,46	125 x 22 mm	40+	12250	10
DF9150.324	€ 3,46	125 x 22 mm	60	12250	10



DN9100-ZC

DISCO LAMELLARE ZIRCO CER CLASSIC

Zirconio
 Nylon
 T27
 Singola
 EN 13743
 Sgross.
 Inox
 Prep. Superficie
 0 - 15°
 Smerigl. angolare
 Made In REFLEX

Art.	€	Dimensioni	Grana	Max rpm	Pack
DN9100.312	€ 3,08	115 x 22 mm	40+	13300	10
DN9100.314	€ 3,08	115 x 22 mm	60	13300	10
DN9100.322	€ 3,46	125 x 22 mm	40+	12250	10
DN9100.324	€ 3,46	125 x 22 mm	60	12250	10



DF9800-ZC

DISCO LAMELLARE ZIRCO CER RAPTOR

Raptor ha una particolare costruzione che esalta le caratteristiche di velocità di asportazione

Zirconio
 Nylon
 T27
 Singola
 EN 13743
 Sgross.
 Inox
 Prep. Superficie
 0 - 15°
 Smerigl. angolare
 Made In REFLEX

Art.	€	Dimensioni	Grana	Max rpm	Pack
DF9800.312	€ 2,79	115 x 22 mm	40	13300	10
DF9800.322	€ 3,08	125 x 22 mm	40	12250	10



SPECIALTY CER

Disco ideale per le lavorazioni di superfici in acciaio inossidabile, soprattutto per forti asportazioni con la più alta velocità di taglio, con tela in abrasivo 100% ceramico con terzo strato refrigerante "top size".

Per applicazioni nei settori alimentare, farmaceutico e chimico. Pensato per gli specialisti dell'inox. Ideale per lavorazioni di lamiere sottili, importanti sbavature di cordoni di saldature e dove si richiede un prodotto che resista alla temperatura con elettrotensili da 1400w e oltre.

SPECIALTY CER è un **disco lamellare** costituito da una tela abrasiva **"TOP SIZE"** con un **abrasivo 100% ceramico**. Questi materiali di elevata qualità consentono una **massima velocità** di taglio assieme ad una **eccezionale durata** del disco. L'ulteriore strato **"TOP SIZE"** riduce drasticamente il surriscaldamento del disco e del pezzo da lavorare con **evidenti benefici nelle lavorazioni degli acciai inossidabili**. Il tessuto in polycotton particolarmente resistente permette **forti pressioni di lavoro**.

DF9101-C

NEW

DISCO LAMELLARE CERAMICO CLASSIC



Art.	€	Dimensioni	Grana	Max rpm	Pack
DF9101.312	€ 3,80	115 x 22 mm	40	13300	10
DF9101.314	€ 3,80	115 x 22 mm	60	13300	10
DF9101.322	€ 4,80	125 x 22 mm	40	12250	10
DF9101.324	€ 4,80	125 x 22 mm	60	12250	10



DN9101-C

NEW

DISCO LAMELLARE CERAMICO CLASSIC



Art.	€	Dimensioni	Grana	Max rpm	Pack
DN9101.312	€ 3,80	115 x 22 mm	40	13300	10
DN9101.314	€ 3,80	115 x 22 mm	60	13300	10
DN9101.322	€ 4,80	125 x 22 mm	40	12250	10
DN9101.324	€ 4,80	125 x 22 mm	60	12250	10



DF9801-C

NEW

DISCO LAMELLARE CERAMICO RAPTOR

Raptor ha una particolare costruzione che esalta le caratteristiche di velocità di asportazione



Art.	€	Dimensioni	Grana	Max rpm	Pack
DF9801.312	€ 3,80	115 x 22 mm	40	13300	10
DF9801.322	€ 4,80	125 x 22 mm	40	12250	10



SPECIALTY ALU

LOW TEMPERATURES, HIGH PERFORMANCE.

Disco ideale per le lavorazioni di superfici in alluminio, con tela Abranet®.

Per lavorazioni di sbavatura e finitura su alluminio e materiali non ferrosi come rame, zinco, ottone, magnesio, oltre che legno e materiali compositi e dove si potrebbe presentare il problema dell'intasamento.

SPECIALTY ALU è un disco speciale realizzato per le lavorazioni dell'Alluminio e, in genere, di tutti i metalli non ferrosi e materiali compositi. È realizzato con uno speciale supporto a rete in poliammide che evita l'intasamento dell'abrasivo e permette la lavorazione del materiale a bassa temperatura.

DF9103-M

DISCO LAMELLARE SPECIALTY ALU CLASSIC



Art.	€	Dimensioni	Grana	Max rpm	Pack
DF9103.512	€ 3,83	115 x 22 mm	40	13300	10
DF9103.514	€ 3,83	115 x 22 mm	60	13300	10
DF9103.515	€ 3,83	115 x 22 mm	80	13300	10
DF9103.517	€ 3,83	115 x 22 mm	120	13300	10
DF9103.522	€ 4,95	125 x 22 mm	40	12250	10
DF9103.524	€ 4,95	125 x 22 mm	60	12250	10
DF9103.525	€ 4,95	125 x 22 mm	80	12250	10
DF9103.527	€ 4,95	125 x 22 mm	120	12250	10



DF9153-M

DISCO LAMELLARE SPECIALTY ALU CLASSIC



Art.	€	Dimensioni	Grana	Max rpm	Pack
DF9153.512	€ 3,83	115 x 22 mm	40	13300	10
DF9153.514	€ 3,83	115 x 22 mm	60	13300	10
DF9153.515	€ 3,83	115 x 22 mm	80	13300	10
DF9153.517	€ 3,83	115 x 22 mm	120	13300	10
DF9153.522	€ 4,95	125 x 22 mm	40	12250	10
DF9153.524	€ 4,95	125 x 22 mm	60	12250	10
DF9153.525	€ 4,95	125 x 22 mm	80	12250	10
DF9153.527	€ 4,95	125 x 22 mm	120	12250	10





MFDXZ

MINI DISCO LAMELLARE

Ad attacco rapido. lunga durata e finitura costante, per asportare con precisione e per lavorare in piccole aree e sui bordi.

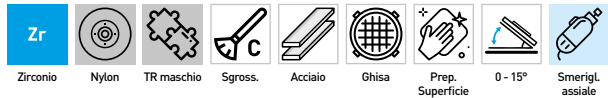

Art.	€	Diametro ø	Grana	Max rpm	Pack
MFD050/040Z	€ 2,22	50 mm	40	25000	10
MFD050/060Z	€ 2,22	50 mm	60	25000	10
MFD050/080Z	€ 2,22	50 mm	80	25000	10
MFD050/120Z	€ 2,22	50 mm	120	25000	10
MFD075/040Z	€ 3,75	75 mm	40	20000	10
MFD075/060Z	€ 3,75	75 mm	60	20000	10
MFD075/080Z	€ 3,75	75 mm	80	20000	10
MFD075/120Z	€ 3,75	75 mm	120	20000	10



MFDXZC

MINI DISCO LAMELLARE CERAMICO

Ad attacco rapido. abrasivo ceramico estremamente duro e tenace, ancora più performante dello zirconio per durata e capacità d'asportazione.

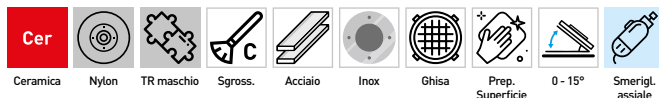

Art.	€	Diametro ø	Grana	Max rpm	Pack
MFD050/040ZC	€ 2,41	50 mm	40	25000	10
MFD050/060ZC	€ 2,41	50 mm	60	25000	10
MFD050/080ZC	€ 2,41	50 mm	80	25000	10

MCDXZ

MINI DISCO LAMELLARE A TAZZA

Ad attacco rapido. più flessibile della forma piana, si adatta a superfici sagomate.



Art.	€	Diametro ø	Grana	Max rpm	Pack
MCD050/040Z	€ 3,30	50 mm	40	25000	10
MCD050/060Z	€ 3,30	50 mm	60	25000	10
MCD050/080Z	€ 3,30	50 mm	80	25000	10
MCD050/120Z	€ 3,30	50 mm	120	25000	10

SGFX

SUPPORTO IN GOMMA

Monoblocco, adatto a tutti i tipi di fast lock.



Art.	€	Diametro ø	Gambo	Max rpm
SGF050/06	€ 8,70	50 mm	6 mm	30000
SGF075/06	€ 10,10	75 mm	6 mm	28000

SFFX

SUPPORTO IN GOMMA

In due parti sia con attacco M14 che con perno, adatto a tutti i tipi di fast-lock.

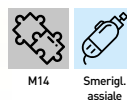

Art.	€	Diametro ø	Filetto	Gambo	Max rpm
SFF050/M14	€ 13,20	50 mm	M14	6 mm	30000
SFF075/M14	€ 14,90	75 mm	M14	6 mm	28000

RMTX

MICRO RUOTE LAMELLARI

ADR3/6 € 10,00

ADATTATORE GAMBO DA 3 mm A 6 mm



RGTX

RUOTE LAMELLARI CON GAMBO IN TELA ALL' OSSIDO DI ALLUMINIO



Art.	€	Diametro ø	H	Gambo	Grana	Max rpm	Pack
RMT1010/060	€ 2,37	10 mm	10 mm	3 mm	60	26000	25
RMT1010/080	€ 2,37	10 mm	10 mm	3 mm	80	26000	25
RMT1010/120	€ 2,37	10 mm	10 mm	3 mm	120	26000	25
RMT1515/060	€ 1,99	15 mm	15 mm	3 mm	60	26000	25
RMT1515/080	€ 1,99	15 mm	15 mm	3 mm	80	26000	25
RMT1515/120	€ 1,99	15 mm	15 mm	3 mm	120	26000	25



Art.	€	Dimensioni	Gambo	Grana	Max rpm	Pack
RGT2010/40	€ 2,16	20 x 10 mm	6 mm	40	26000	10
RGT2010/60	€ 2,16	20 x 10 mm	6 mm	60	26000	10
RGT2010/80	€ 2,16	20 x 10 mm	6 mm	80	26000	10
RGT2010/120	€ 2,16	20 x 10 mm	6 mm	120	26000	10
RGT2015/40	€ 2,16	20 x 15 mm	6 mm	40	25000	10
RGT2015/60	€ 2,16	20 x 15 mm	6 mm	60	25000	10
RGT2015/80	€ 2,16	20 x 15 mm	6 mm	80	25000	10
RGT2015/120	€ 2,16	20 x 15 mm	6 mm	120	25000	10
RGT2515/60	€ 2,05	25 x 15 mm	6 mm	60	25000	10
RGT2515/80	€ 2,05	25 x 15 mm	6 mm	80	25000	10
RGT2515/120	€ 2,05	25 x 15 mm	6 mm	120	25000	10
RGT2525/40	€ 2,04	25 x 25 mm	6 mm	40	25000	10
RGT2525/60	€ 2,04	25 x 25 mm	6 mm	60	25000	10
RGT2525/80	€ 2,04	25 x 25 mm	6 mm	80	25000	10
RGT2525/120	€ 2,04	25 x 25 mm	6 mm	120	25000	10
RGT3010/40	€ 1,97	30 x 10 mm	6 mm	40	22900	10
RGT3010/60	€ 1,97	30 x 10 mm	6 mm	60	22900	10
RGT3010/80	€ 1,97	30 x 10 mm	6 mm	80	22900	10
RGT3010/120	€ 1,97	30 x 10 mm	6 mm	120	22900	10
RGT3015/40	€ 2,16	30 x 15 mm	6 mm	40	22900	10
RGT3015/60	€ 2,16	30 x 15 mm	6 mm	60	22900	10
RGT3015/80	€ 2,16	30 x 15 mm	6 mm	80	22900	10
RGT3015/120	€ 2,16	30 x 15 mm	6 mm	120	22900	10
RGT3020/40	€ 2,29	30 x 20 mm	6 mm	40	22900	10
RGT3020/60	€ 2,29	30 x 20 mm	6 mm	60	22900	10
RGT3020/80	€ 2,29	30 x 20 mm	6 mm	80	22900	10
RGT3020/120	€ 2,29	30 x 20 mm	6 mm	120	22900	10
RGT4015/40	€ 2,31	40 x 15 mm	6 mm	40	17100	10
RGT4015/60	€ 2,31	40 x 15 mm	6 mm	60	17100	10
RGT4015/80	€ 2,38	40 x 15 mm	6 mm	80	17100	10
RGT4015/120	€ 2,38	40 x 15 mm	6 mm	120	17100	10
RGT4020/40	€ 2,38	40 x 20 mm	6 mm	40	17100	10
RGT4020/60	€ 2,38	40 x 20 mm	6 mm	60	17100	10
RGT4020/80	€ 2,38	40 x 20 mm	6 mm	80	17100	10
RGT4020/120	€ 2,38	40 x 20 mm	6 mm	120	17100	10
RGT4030/40	€ 2,72	40 x 30 mm	6 mm	40	17100	10
RGT4030/60	€ 2,72	40 x 30 mm	6 mm	60	17100	10
RGT4030/80	€ 2,72	40 x 30 mm	6 mm	80	17100	10
RGT4030/120	€ 2,72	40 x 30 mm	6 mm	120	17100	10
RGT5020/40	€ 2,48	50 x 20 mm	6 mm	40	13700	10
RGT5020/60	€ 2,48	50 x 20 mm	6 mm	60	13700	10
RGT5020/80	€ 2,48	50 x 20 mm	6 mm	80	13700	10
RGT5020/120	€ 2,48	50 x 20 mm	6 mm	120	13700	10
RGT5030/40	€ 2,93	50 x 30 mm	6 mm	40	11400	10
RGT5030/60	€ 2,93	50 x 30 mm	6 mm	60	11400	10
RGT5030/80	€ 2,93	50 x 30 mm	6 mm	80	11400	10
RGT5030/120	€ 2,93	50 x 30 mm	6 mm	120	11400	10
RGT6020/40	€ 3,28	60 x 20 mm	6 mm	40	11400	10
RGT6020/60	€ 3,28	60 x 20 mm	6 mm	60	11400	10
RGT6020/80	€ 3,28	60 x 20 mm	6 mm	80	11400	10
RGT6020/120	€ 3,28	60 x 20 mm	6 mm	120	11400	10
RGT6030/40	€ 3,60	60 x 30 mm	6 mm	40	11400	10
RGT6030/60	€ 3,60	60 x 30 mm	6 mm	60	11400	10
RGT6030/80	€ 3,60	60 x 30 mm	6 mm	80	11400	10
RGT6030/120	€ 3,60	60 x 30 mm	6 mm	120	11400	10

RGMX

RUOTE CON GAMBO MISTE IN TELA E PANNO ABRASIVO

Costituite da lamelle di panno abrasivo intercalate a lamelle di tela disposte in senso radiale.



Art.	€	Dimensioni	Gambo	Panno	Tela	Pack
RGM030/20M	€ 4,34	30 x 20 mm	6 mm	A/O-M	60	10
RGM030/20F	€ 4,34	30 x 20 mm	6 mm	A/O-F	100	10
RGM030/20VF	€ 4,34	30 x 20 mm	6 mm	A/O-VF	150	10
RGM040/20M	€ 5,20	40 x 20 mm	6 mm	A/O-M	60	10
RGM040/20F	€ 5,20	40 x 20 mm	6 mm	A/O-F	100	10
RGM040/20VF	€ 5,20	40 x 20 mm	6 mm	A/O-VF	150	10
RGM050/30M	€ 5,80	50 x 30 mm	6 mm	A/O-M	60	10
RGM050/30F	€ 5,80	50 x 30 mm	6 mm	A/O-F	100	10
RGM050/30VF	€ 5,80	50 x 30 mm	6 mm	A/O-VF	150	10
RGM060/30M	€ 6,60	60 x 30 mm	6 mm	A/O-M	60	10
RGM060/30F	€ 6,60	60 x 30 mm	6 mm	A/O-F	100	10
RGM060/30VF	€ 6,60	60 x 30 mm	6 mm	A/O-VF	150	10
RGM080/50M	€ 8,60	80 x 50 mm	6 mm	A/O-M	60	10
RGM080/50F	€ 8,60	80 x 50 mm	6 mm	A/O-F	100	10
RGM080/50VF	€ 8,60	80 x 50 mm	6 mm	A/O-VF	150	10



RFTX

RUOTE LAMELLARI CON FORO IN TELA ALL'OSSIDO DI ALLUMINIO

Le ruote si possono contro sagomare sul profilo del pezzo da lavorare. lubrificando la ruota con olio o con grasso, si migliora il grado di finitura, la durata della ruota stessa e si svolge un'azione antipolvere.

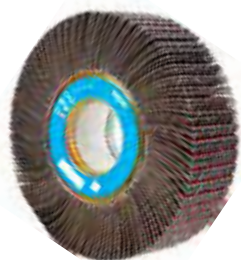

Art.	€	Dimensioni	Grana	Max rpm
RFT165/25040	€ 20,20	165 x 25 x 54 mm	40	5200
RFT165/25060	€ 20,80	165 x 25 x 54 mm	60	5200
RFT165/25080	€ 21,00	165 x 25 x 54 mm	80	5200
RFT165/25120	€ 21,60	165 x 25 x 54 mm	120	5200
RFT165/25220	€ 27,30	165 x 25 x 54 mm	220	5200
RFT165/30040	€ 21,10	165 x 30 x 54 mm	40	5200
RFT165/30060	€ 34,10	165 x 30 x 54 mm	60	5200
RFT165/30080	€ 21,80	165 x 30 x 54 mm	80	5200
RFT165/30120	€ 22,70	165 x 30 x 54 mm	120	5200
RFT165/30220	€ 44,80	165 x 30 x 54 mm	220	5200
RFT165/50040	€ 40,00	165 x 50 x 54 mm	40	5200
RFT165/50060	€ 43,20	165 x 50 x 54 mm	60	5200
RFT165/50080	€ 44,10	165 x 50 x 54 mm	80	5200
RFT165/50120	€ 47,90	165 x 50 x 54 mm	120	5200
RFT165/50220	€ 41,20	165 x 50 x 54 mm	220	5200
RFT165/50040A	€ 29,30	165 x 50 x 25 mm	40	5200
RFT165/50060A	€ 29,80	165 x 50 x 25 mm	60	5200
RFT165/50080A	€ 30,90	165 x 50 x 25 mm	80	5200
RFT165/50120A	€ 31,90	165 x 50 x 25 mm	120	5200
RFT165/50220A	€ 41,20	165 x 50 x 25 mm	220	5200
RFT200/50040	€ 34,80	200 x 50 x 54 mm	40	3800
RFT200/50060	€ 38,30	200 x 50 x 54 mm	60	3800
RFT200/50080	€ 39,70	200 x 50 x 54 mm	80	3800
RFT200/50120	€ 41,00	200 x 50 x 54 mm	120	3800
RFT250/50040	€ 66,20	250 x 50 x 100 mm	40	3400
RFT250/50060	€ 70,40	250 x 50 x 100 mm	60	3400
RFT250/50080	€ 114,00	250 x 50 x 100 mm	80	3400
RFT250/50120	€ 118,00	250 x 50 x 100 mm	120	3400

FRFX

COPPIA DI FLANGE



Art.	€	Misura	Foro
FRF54/20	€ 17,00	54 mm	20 mm
FRF54/25	€ 17,00	54 mm	25 mm

RGPX

RUOTE CON GAMBO IN PANNO ABRASIVO

Costituite da lamelle disposte in senso radiale



Art.	€	Dimensioni	Gambo	Grana	Pack
RGPO30/20C	€ 3,76	30 x 20 mm	6 mm	COARSE	10
RGPO30/20M	€ 3,76	30 x 20 mm	6 mm	MEDIUM	10
RGPO30/20F	€ 3,76	30 x 20 mm	6 mm	FINE	10
RGPO30/20VF	€ 3,76	30 x 20 mm	6 mm	VERY FINE	10
RGPO40/20C	€ 4,02	40 x 20 mm	6 mm	COARSE	10
RGPO40/20M	€ 4,02	40 x 20 mm	6 mm	MEDIUM	10
RGPO40/20F	€ 4,02	40 x 20 mm	6 mm	FINE	10
RGPO40/20VF	€ 4,02	40 x 20 mm	6 mm	VERY FINE	10
RGPO50/30C	€ 5,10	50 x 30 mm	6 mm	COARSE	10
RGPO50/30M	€ 5,10	50 x 30 mm	6 mm	MEDIUM	10
RGPO50/30F	€ 5,10	50 x 30 mm	6 mm	FINE	10
RGPO50/30VF	€ 5,10	50 x 30 mm	6 mm	VERY FINE	10
RGPO60/30C	€ 5,30	60 x 30 mm	6 mm	COARSE	10
RGPO60/30M	€ 5,30	60 x 30 mm	6 mm	MEDIUM	10
RGPO60/30F	€ 5,30	60 x 30 mm	6 mm	FINE	10
RGPO60/30VF	€ 5,30	60 x 30 mm	6 mm	VERY FINE	10
RGPO80/50C	€ 8,20	80 x 50 mm	6 mm	COARSE	10
RGPO80/50M	€ 8,20	80 x 50 mm	6 mm	MEDIUM	10
RGPO80/50F	€ 8,20	80 x 50 mm	6 mm	FINE	10
RGPO80/50VF	€ 8,20	80 x 50 mm	6 mm	VERY FINE	10

RLFX

RUOTE LAMELLARI CON FORO FILETTATO

Per l'impiego con smerigliatrici angolari (foro filettato M14), per rimuovere leggere saldature su superfici tonde e sagomate.



Art.	€	Misura	Filetto	Grana	Max rpm
RLF115/040	€ 13,10	Ø 115 x 20 mm	M14	40	9000
RLF115/060	€ 13,10	Ø 115 x 20 mm	M14	60	9000
RLF115/080	€ 13,10	Ø 115 x 20 mm	M14	80	9000
RLF115/120	€ 13,10	Ø 115 x 20 mm	M14	120	9000
RLF125/040	€ 14,30	Ø 115 x 20 mm	M14	40	9000
RLF125/060	€ 14,30	Ø 125 X 20 mm	M14	60	9000
RLF125/080	€ 14,30	Ø 125 X 20 mm	M14	80	9000
RLF125/120	€ 14,30	Ø 125 X 20 mm	M14	120	9000

RFPX

RUOTE CON FORO IN PANNO ABRASIVO

Costituite da lamelle di panno abrasivo disposte in senso radiale.



Art.	€	Dimensioni	Grana
RFP165/50M	€ 16,20	165 x 50 x 65 mm	Medium
RFP165/50F	€ 16,20	165 x 50 x 65 mm	Fine
RFP165/50VF	€ 16,20	165 x 50 x 65 mm	Very Fine
RFP200/50M	€ 22,70	200 x 50 x 110 mm	Medium
RFP200/50F	€ 22,70	200 x 50 x 110 mm	Fine
RFP200/50VF	€ 22,70	200 x 50 x 110 mm	Very Fine

RLMX

RUOTE LAMELLARI MISTE



Art.	€	Dimensioni	Panno	Tela	Diametro foro
RLM100/060C	€ 18,10	100 x 100 mm	A/C	60	19 mm
RLM100/080M	€ 18,10	100 x 100 mm	A/M	80	19 mm
RLM100/150F	€ 18,10	100 x 100 mm	A/F	150	19 mm

NAS100X-Z

NASTRI IN ZIRCONIO



Art.	€	Dimensioni	Grana
NAS100/040Z	€ 2,63	90 x 100 mm	40
NAS100/060Z	€ 2,63	90 x 100 mm	60
NAS100/080Z	€ 2,63	90 x 100 mm	80
NAS100/120Z	€ 2,63	90 x 100 mm	120

RLTX

RUOTE LAMELLARI IN TELA



Art.	€	Dimensioni	Grana	Diametro foro
RLT050/040	€ 15,20	100 x 50 mm	40	19 mm
RLT050/060	€ 15,20	100 x 50 mm	60	19 mm
RLT050/080	€ 15,20	100 x 50 mm	80	19 mm
RLT050/120	€ 15,20	100 x 50 mm	120	19 mm
RLT100/040	€ 22,10	100 x 100 mm	40	19 mm
RLT100/060	€ 22,10	100 x 100 mm	60	19 mm
RLT100/080	€ 23,10	100 x 100 mm	80	19 mm
RLT100/120	€ 23,10	100 x 100 mm	120	19 mm

RLPX

RUOTE LAMELLARI IN PANNO ABRASIVO

Colore diversificato in base alla grana



Art.	€	Dimensioni	Grana	Diametro foro
RLP100/C	€ 16,00	100 x 100 mm	A/O-C	19 mm
RLP100/M	€ 15,10	100 x 100 mm	A/O-M	19 mm
RLP100/F	€ 15,10	100 x 100 mm	A/O-F	19 mm
RLP100/VF	€ 15,10	100 x 100 mm	A/O-VF	19 mm

NAS100X-A

NASTRI IN OSSIDO DI ALLUMINIO



Art.	€	Dimensioni	Grana
NAS100/180A	€ 2,38	90 x 100 mm	180
NAS100/240A	€ 2,38	90 x 100 mm	240



NAS100X-C

NASTRI CERAMICI



Art.	€	Dimensioni	Grana
NAS100/040C	€ 5,30	90 x 100 mm	40
NAS100/060C	€ 4,79	90 x 100 mm	60
NAS100/080C	€ 4,55	90 x 100 mm	80
NAS100/120C	€ 4,13	90 x 100 mm	120

NAT100X

NASTRI TRIZACT

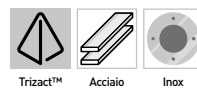

Art.	€	Dimensioni	Grana
NAT100/A006	€ 8,50	90 x 100 mm	A6
NAT100/A016	€ 8,50	90 x 100 mm	A16
NAT100/A030	€ 8,50	90 x 100 mm	A30
NAT100/A045	€ 8,50	90 x 100 mm	A45
NAT100/A065	€ 8,50	90 x 100 mm	A65
NAT100/A100	€ 8,50	90 x 100 mm	A100
NAT100/A160	€ 8,50	90 x 100 mm	A160

SCSX

NASTRI SURFACE CONDITIONING



Art.	€	Dimensioni	Grana
SCS100/C	€ 13,60	90 x 100 mm	Coarse
SCS100/M	€ 12,90	90 x 100 mm	Medium
SCS100/VF	€ 12,90	90 x 100 mm	Very fine

RPW090

€ 89,90

ESPANSORE PNEUMATICO



Dimensioni	90 x 90 mm
Foro	19.1 mm
Max rpm	6000

ERW100

€ 75,50

ESPANSORE CENTRIFUGO



Dimensioni	90 x 100 mm
Foro	19.1 - 35 mm
Max rpm	6000

SWS100

€ 82,10

RUOTA IN FILI DI ACCIAIO OTTONATO

Per sbavare, sverniciare, eliminare ruggine e calamina e rusticare il legno.



Dimensioni	100 x 100 mm
Foro	19.1 mm
Filo	0.3 mm
Max rpm	6800

SWS100/M € 94,80

RUOTA IN FILI DI ACCIAIO OTTONATO

Adatto a macchine Makita, per sbavare, sverniciare, eliminare ruggine e calamina e rusticare il legno



Dimensioni	100 x 100 mm
Foro	13 mm
Filo	0.3 mm
Max rpm	6800

NWS100 € 142,00

RUOTE IN FILO DI NYLON ABRASIVO

Per pulire i metalli e rusticare il legno.



Dimensioni	100 x 100 mm
Foro	19.1 mm
Grana	80
Max rpm	6800

NWS100/M € 152,00

RUOTE IN FILO DI NYLON ABRASIVO

Adatto a macchine Makita, per pulire i metalli e rusticare il legno



Dimensioni	100 x 100 mm
Foro	13 mm
Grana	80
Max rpm	6800



**FDCX****FIBRODISCO FLESSIBILE VIPER**

Disco flessibile innovativo a centro depresso con supporto in fibra integrato per una operazione di sbavatura veloce precisa e confortevole di superfici piane e curve, cordoni di saldatura e spigoli vivi

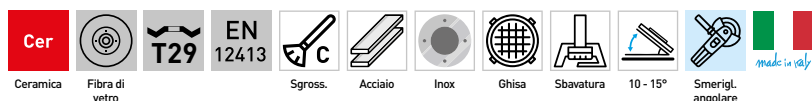

Art.	€	Dimensioni	Durezza	Max rpm	Pack
FDC115/036	€ 4,56	115x22,23 mm	SG 36	13300	25
FDC115/060	€ 4,56	115x22,23 mm	SG 60	13300	25
FDC115/120	€ 4,56	115x22,23 mm	SG 120	13300	25
FDC125/036	€ 4,72	125x22,23 mm	SG 36	12250	25

**DFVX-XZ****DISCHI IN FIBRA VULCANIZZATA**

I dischi in fibra sono costituiti da un supporto di spessore 0,8 mm in fibra di cellulosa vulcanizzata sulla quale vengono depositi vari tipi di abrasivo. questi sono legati con un doppio strato di resina termoindurente additivata con cariche attive che conferiscono ai prodotti proprietà raffreddanti e anti intasamento. applicati ad un platello di supporto, vengono usati su levigatrici portatili.

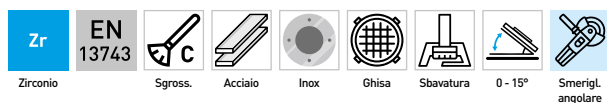

Art.	€	Dimensioni	Grana	Max rpm	Pack
DFV115/036Z	€ 0,83	115 x 22 mm	36	13300	25
DFV115/040Z	€ 0,74	115 x 22 mm	40	13300	25
DFV115/060Z	€ 0,68	115 x 22 mm	60	13300	25
DFV115/080Z	€ 0,63	115 x 22 mm	80	13300	25
DFV115/120Z	€ 0,55	115 x 22 mm	120	13300	25
DFV180/036Z	€ 1,87	180 x 22 mm	36	8600	25
DFV180/040Z	€ 1,67	180 x 22 mm	40	8600	25
DFV180/060Z	€ 1,43	180 x 22 mm	60	8600	25
DFV180/080Z	€ 1,38	180 x 22 mm	80	8600	25
DFV180/120Z	€ 1,22	180 x 22 mm	120	8600	25

**DFVX-XA****DISCHI IN FIBRA VULCANIZZATA**

I dischi in fibra sono costituiti da un supporto di spessore 0,8 mm in fibra di cellulosa vulcanizzata sulla quale vengono depositi vari tipi di abrasivo. questi sono legati con un doppio strato di resina termoindurente additivata con cariche attive che conferiscono ai prodotti proprietà raffreddanti e anti intasamento. applicati ad un platello di supporto, vengono usati su levigatrici portatili.



Art.	€	Dimensioni	Grana	Max rpm	Pack
DFV115/024A	€ 0,59	115 x 22 mm	24	13300	25
DFV115/036A	€ 0,63	115 x 22 mm	36	13300	25
DFV115/060A	€ 0,59	115 x 22 mm	60	13300	25
DFV115/080A	€ 0,48	115 x 22 mm	80	13300	25
DFV115/120A	€ 0,48	115 x 22 mm	120	13300	25
DFV180/024A	€ 1,32	180 x 22 mm	24	8600	25
DFV180/036A	€ 1,28	180 x 22 mm	36	8600	25
DFV180/060A	€ 1,19	180 x 22 mm	60	8600	25
DFV180/080A	€ 1,13	180 x 22 mm	80	8600	25



PFBX

PLATORELLI DI SUPPORTO

Standard per dischi fibriati, di tipo professionale, duro.

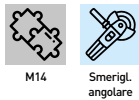

Art.	€	Diametro ø	Filetto	Max rpm
PFB115	€ 5,10	115 mm	M14	13300
PFB180	€ 8,80	180 mm	M14	8500

PFSX

PLATORELLI DI SUPPORTO

Per dischi fibriati. le scanalature favoriscono una dispersione del calore e un contatto più aggressivo con la superficie. adatto per lavorazioni con pressioni forti sul disco, per utilizzo di grane grosse. molto duro.

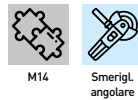

Art.	€	Diametro ø	Filetto	Max rpm
PFS115	€ 9,80	115 mm	M14	13300
PFS180	€ 17,60	180 mm	M14	8500

MDAXZT

FAST LOCK ZIRCONIO TOP SIZE

Ad attacco rapido. lunga durata e finitura costante, per asportare con precisione e per lavorare in piccole aree e sui bordi.



Art.	€	Diametro ø	Grana	Max rpm	Pack
MDA050/036ZT	€ 0,77	50 mm	36	25000	25
MDA050/060ZT	€ 0,76	50 mm	60	25000	25
MDA050/080ZT	€ 0,76	50 mm	80	25000	25
MDA050/120ZT	€ 0,76	50 mm	120	25000	25
MDA075/036ZT	€ 1,28	75 mm	36	20000	25
MDA075/060ZT	€ 1,21	75 mm	60	20000	25
MDA075/080ZT	€ 1,21	75 mm	80	20000	25
MDA075/120ZT	€ 1,21	75 mm	120	20000	25

D17X

DISCHI ABRASIVI CON SUPPORTO ADESIVO



Art.	€	Misure	Grana	Pack
D174	€ 1,34	150 mm	60	10
D175	€ 1,34	150 mm	100	10
D178/060	€ 1,34	200 mm	60	10
D178/100	€ 1,34	200 mm	100	10
D176	€ 2,26	226 mm	60	10
D177	€ 2,26	226 mm	100	10



VDAX

DISCHI VELCRATI

Corindone resinato su carta pesante (peso F), cosparsione chiusa



Art.	€	Diametro ø	Fori	Grana	Pack
VDA115/040	€ 0,30	115 mm	-	40	50
VDA115/060	€ 0,30	115 mm	-	60	100
VDA115/080	€ 0,30	115 mm	-	80	100
VDA115/100	€ 0,30	115 mm	-	100	100
VDA115/120	€ 0,30	115 mm	-	120	100
VDA115/180	€ 0,30	115 mm	-	180	100
VDA115/220	€ 0,30	115 mm	-	220	100
VDA125/40F8	€ 0,37	125 mm	8	40	50
VDA125/60F8	€ 0,34	125 mm	8	60	100
VDA125/80F8	€ 0,34	125 mm	8	80	100
VDA125/100F8	€ 0,34	125 mm	8	100	100
VDA125/120F8	€ 0,34	125 mm	8	120	100
VDA125/180F8	€ 0,34	125 mm	8	180	100
VDA125/220F8	€ 0,34	125 mm	8	220	100
VDA150/040	€ 0,47	150 mm	-	40	50
VDA150/060	€ 0,43	150 mm	-	60	100
VDA150/080	€ 0,43	150 mm	-	80	100
VDA150/100	€ 0,43	150 mm	-	100	100
VDA150/120	€ 0,43	150 mm	-	120	100
VDA150/180	€ 0,43	150 mm	-	180	100
VDA150/220	€ 0,43	150 mm	-	220	100
VDA150/040F6	€ 0,47	150 mm	6	40	50
VDA150/060F6	€ 0,43	150 mm	6	60	100
VDA150/080F6	€ 0,43	150 mm	6	80	100
VDA150/100F6	€ 0,43	150 mm	6	100	100
VDA150/120F6	€ 0,43	150 mm	6	120	100
VDA150/180F6	€ 0,43	150 mm	6	180	100
VDA150/220F6	€ 0,43	150 mm	6	220	100

VDGX

DISCO VELCRATO GOLD

Corindone stearato doppia resina su carta leggera (peso C), cosparsione semi aperta. L'aggiunta di stearato di zinco previene l'intasamento.



Art.	€	Diametro	Grana	Fori	Pack
VDG150/060	€ 0,45	ø 150 mm	60	-	100
VDG150/080	€ 0,43	ø 150 mm	80	-	100
VDG150/120	€ 0,43	ø 150 mm	120	-	100
VDG150/150	€ 0,43	ø 150 mm	150	-	100
VDG150/180	€ 0,43	ø 150 mm	180	-	100
VDG150/220	€ 0,43	ø 150 mm	220	-	100
VDG150/320	€ 0,43	ø 150 mm	320	-	100
VDG150/400	€ 0,43	ø 150 mm	400	-	100
VDG150/600	€ 0,43	ø 150 mm	600	-	100
VDG150/800	€ 0,43	ø 150 mm	800	-	100
VDG150/060F6	€ 0,45	ø 150 mm	60	6	100
VDG150/080F6	€ 0,43	ø 150 mm	80	6	100
VDG150/120F6	€ 0,43	ø 150 mm	120	6	100
VDG150/150F6	€ 0,43	ø 150 mm	150	6	100
VDG150/180F6	€ 0,43	ø 150 mm	180	6	100
VDG150/220F6	€ 0,43	ø 150 mm	220	6	100
VDG150/320F6	€ 0,43	ø 150 mm	320	6	100
VDG150/400F6	€ 0,43	ø 150 mm	400	6	100
VDG150/600F6	€ 0,43	ø 150 mm	600	6	100
VDG150/800F6	€ 0,43	ø 150 mm	800	6	100
VDG150/060F8	€ 0,45	ø 150 mm	60	8	100
VDG150/080F8	€ 0,43	ø 150 mm	80	8	100
VDG150/120F8	€ 0,43	ø 150 mm	120	8	100
VDG150/150F8	€ 0,43	ø 150 mm	150	8	100
VDG150/180F8	€ 0,43	ø 150 mm	180	8	100
VDG150/220F8	€ 0,43	ø 150 mm	220	8	100
VDG150/320F8	€ 0,43	ø 150 mm	320	8	100
VDG150/400F8	€ 0,43	ø 150 mm	400	8	100
VDG150/600F8	€ 0,43	ø 150 mm	600	8	100
VDG150/800F8	€ 0,43	ø 150 mm	800	8	100

ZSAX
DISCHI VELCRATI

Corindone stearato doppia resina su carta leggera (peso C), cosparsione chiusa. L'aggiunta di stearato di zinco previene l'intasamento.

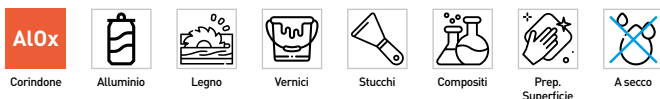

Art.	€	Diametro ø	Fori	Grana	Pack
ZSA150/080	€ 0,43	150 mm	-	80	100
ZSA150/120	€ 0,39	150 mm	-	120	100
ZSA150/180	€ 0,39	150 mm	-	180	100
ZSA150/240	€ 0,39	150 mm	-	240	100
ZSA150/320	€ 0,39	150 mm	-	320	100
ZSA150/400	€ 0,39	150 mm	-	400	100
ZSA150/80F6	€ 0,43	150 mm	6	80	100
ZSA150/120F6	€ 0,39	150 mm	6	120	100
ZSA150/180F6	€ 0,39	150 mm	6	180	100
ZSA150/240F6	€ 0,39	150 mm	6	240	100
ZSA150/320F6	€ 0,39	150 mm	6	320	100
ZSA150/400F6	€ 0,39	150 mm	6	400	100

VDZX
DISCHI VELCRATI

Zirconio resinato su carta pesante (peso F), cosparsione chiusa. Qualità top, molto aggressivo e di lunga durata, il supporto resiste a sollecitazioni e velocità più elevate dei dischi di carta.

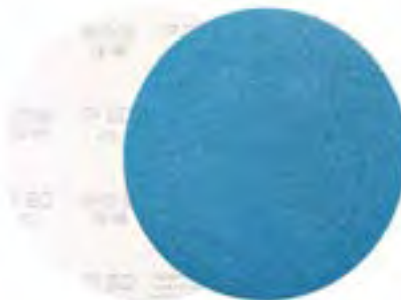

Art.	€	Diametro ø	Grana	Pack
VDZ115/040	€ 0,65	115 mm	40	50
VDZ115/060	€ 0,63	115 mm	60	100
VDZ115/080	€ 0,58	115 mm	80	100
VDZ115/120	€ 0,54	115 mm	120	100
VDZ125/040	€ 0,78	125 mm	40	100
VDZ125/060	€ 0,67	125 mm	60	100
VDZ125/080	€ 0,65	125 mm	80	100
VDZ125/120	€ 0,58	125 mm	120	100
VDZ150/040	€ 1,03	150 mm	40	50
VDZ150/060	€ 0,87	150 mm	60	100
VDZ150/080	€ 0,82	150 mm	80	100
VDZ150/120	€ 0,78	150 mm	120	100

VDRX
DISCHI IN RETE VELCRATI

Supporto fatto di rete permette di aspirare fino al 90% delle polveri generate dall'abrasione, resiste al calore rendendoli utilizzabili anche con smerigliatrici angolari, utilizzabile a secco e umido. Durata più lunga ed ambiente di lavoro più sano grazie all'aspirazione dei residui.



Art.	€	Diametro ø	Grana	Pack
VDR150/080	€ 0,82	150 mm	80	50
VDR150/120	€ 0,82	150 mm	120	50
VDR150/180	€ 0,82	150 mm	180	50
VDR150/240	€ 0,82	150 mm	240	50
VDR150/320	€ 0,82	150 mm	320	50
VDR150/400	€ 0,82	150 mm	400	50
VDR150/600	€ 0,82	150 mm	600	50

PDBX
PLATORELLI SENZA MOUSSE

Per dischi velcrati



Art.	€	Diametro ø	Filetto	Max rpm
PDB115/M14	€ 9,20	115 mm	M14	13300
PDB125/M14	€ 10,50	125 mm	M14	12200
PDB150/M14	€ 14,10	150 mm	M14	10000

PDMX
PLATORELLI CON MOUSSE

Versione professionale, per dischi velcrati, per adattarsi meglio al pezzo da lavorare.



Art.	€	Diametro ø	Spessore	Filetto	Max rpm
PDM115/12M14	€ 16,40	115 mm	12 mm	M14	13300
PDM125/12M14	€ 18,70	125 mm	12 mm	M14	12200
PDM150/12M14	€ 21,30	150 mm	12 mm	M14	10000

**PMEX****PLATORELLI CON MOUSSE**

Per dischi velcrati, per adattarsi meglio al pezzo da lavorare.



M14



A secco

Smerigl.
angolareLevigatrice
Orbitale

Art.	€	Diametro ø	Spessore	Filetto	Max rpm
PME125/18M14	€ 5,10	125 mm	18 mm	M14	6800
PME150/12M14	€ 7,20	150 mm	12 mm	M14	10000

PPSX**PLATORELLI IN POLIURETANO**

Per dischi velcrati, versione morbida.



M14



A secco

Smerigl.
angolareLevigatrice
Orbitale

Art.	€	Diametro ø	Spessore	Filetto	Max rpm
PPS125/27M14	€ 20,10	125 mm	27 mm	M14	8000
PPS150/29M14	€ 21,60	150 mm	29 mm	M14	7000

PDVX-M14**PLATORELLO CON VENTILAZIONE**

Per dischi velcrati, le scanalature migliorano la dispersione del calore aumentando la vita dell'abrasivo evitando il surriscaldamento del pezzo da lavorare.



M14



A secco

Smerigl.
angolareLevigatrice
Orbitale

Art.	€	Diametro ø	Filetto
PDV115/M14	€ 31,20	115 mm	M14
PDV125/M14	€ 32,00	125 mm	M14
PDV150/M14	€ 35,20	150 mm	M14

0459

€ 7,10

PLATORELLO CON FISSAGGIO A STRAPPO

Da 150mm, con 6 fori, filetto maschio da 5/16"-24 filetti per pollice.



Append.



Diametro disco	150 mm - 6"
Velocità max di utilizzo	12000 rpm

PFLX**PLATORELLI PER LEVIGATRICI ROTORBITALI**

A secco

Levigatrice
Orbitale

Art.	€	Diametro ø	Spessore	Gambo	Fori	Max rpm
PFL125/10F8	€ 14,70	125 mm	10 mm	5/16" mm	8	12000
PFL150/10	€ 17,10	150 mm	10 mm	5/16" mm	-	10000
PFL150/10F6	€ 18,40	150 mm	10 mm	5/16" mm	6	10000

**TEV120**

€ 9,80

BLOCCO PER DISCHI VELCRATI

Forma ergonomica, cambio rapido del foglio abrasivo.



A secco

Utilizzo
Manuale

Misura	70 x 120 mm
--------	-------------

TDV

€ 17,90

BLOCCO PER DISCHI VELCRATI

Consente di usare a mano i dischi a strappo.



A secco

Utilizzo
Manuale

Misura	150 mm
--------	--------

RASX

ROTOLI ANTI SPRECO

Tela extra flessibile doppia resina. Specifica per torneria, stampi, armi e per tutte le lavorazioni che necessitano di una tela ad elevata flessibilità e durata superiore

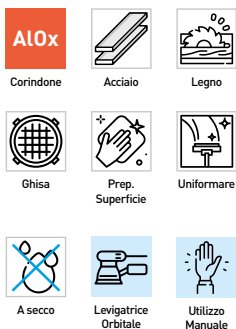

Art.	€	Dimensioni	Grana
RAS40	€ 26,90	50 mm x 25 m	40
RAS60	€ 24,20	50 mm x 25 m	60
RAS80	€ 23,00	50 mm x 25 m	80
RAS120	€ 20,10	50 mm x 25 m	120
RAS180	€ 20,10	50 mm x 25 m	180
RAS220	€ 20,10	50 mm x 25 m	220
RAS320	€ 20,10	50 mm x 25 m	320
RAS400	€ 20,10	50 mm x 25 m	400

RSSX

ROTOLI ANTI SPRECO IN SPUGNA

Carta auto lubrificante peso C al corindone accoppiata con spugna.

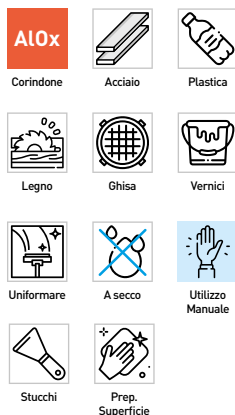

Art.	€	Dimensioni	Grana
RSS150	€ 67,20	115 mm x 25 m	150
RSS180	€ 67,20	115 mm x 25 m	180
RSS240	€ 67,20	115 mm x 25 m	240
RSS320	€ 67,20	115 mm x 25 m	320
RSS400	€ 67,20	115 mm x 25 m	400
RSS500	€ 67,20	115 mm x 25 m	500
RSS600	€ 67,20	115 mm x 25 m	600
RSS800	€ 67,20	115 mm x 25 m	800
RSS1000	€ 67,20	115 mm x 25 m	1000

RSRX

ROTOLI A STRAPPO VELCRATI DI CARTA RESINATA

Carta al corindone antistatica, cosparsione semi aperta, peso E. Uso a secco, adatta alla lavorazione di legno, pelle, stucchi e metallo.



Art.	€	Dimensioni	Grana
RSR115/050/040	€ 61,40	115 x 25 m	40
RSR115/050/060	€ 53,10	115 x 25 m	60
RSR115/050/080	€ 49,20	115 x 25 m	80
RSR115/050/120	€ 48,10	115 x 25 m	120

RSAX

ROTOLI A STRAPPO VELCRATI DI CARTA AUTOLUBRIFICANTE

Corindone stearato su carta leggera (peso C), cosparsione semi aperta, uso a secco



Art.	€	Dimensioni	Grana
RSA115/25/080	€ 47,30	115 mm x 25 m	80
RSA115/25/120	€ 47,30	115 mm x 25 m	120
RSA115/25/150	€ 47,30	115 mm x 25 m	150
RSA115/25/180	€ 47,30	115 mm x 25 m	180
RSA115/25/220	€ 47,30	115 mm x 25 m	220
RSA115/25/320	€ 47,30	115 mm x 25 m	320

**FTRX****FOGLI DI TELA RESINATA**

Tela flessibile con supporto in cotone



Corindone



Acciaio



Alluminio



Legno



Ghisa

Prep.
Superficie

Uniformare



A secco

Levigatrice
OrbitaleUtilizzo
Manuale

Art.	€	Dimensioni	Grana	Pack
FTR230/040	€ 1,35	230 x 280 mm	40	50
FTR230/060	€ 1,21	230 x 280 mm	60	50
FTR230/080	€ 1,11	230 x 280 mm	80	50
FTR230/120	€ 0,98	230 x 280 mm	120	50
FTR230/180	€ 0,98	230 x 280 mm	180	50
FTR230/220	€ 0,98	230 x 280 mm	220	50
FTR230/320	€ 0,98	230 x 280 mm	320	50
FTR230/400	€ 0,98	230 x 280 mm	400	50
FTR230/600	€ 1,11	230 x 280 mm	600	50

RCLX**ROLOI DI CARTA LATTICE**

Carta supporto lattice per finitura a secco o umido, impiegata per la finitura e levigatura di stampi metallici, pezzi di fibra di carbonio, fibra di vetro, materiali compositi e strumenti di precisione.



Corindone



Finitura



Acciaio



Compositi



Uniformare



Acqua



A secco

Utilizzo
Manuale

Art.	€	Dimensioni	Grana
RCL115/100/080	€ 117,00	115 mm x 100 m	80
RCL115/100/100	€ 117,00	115 mm x 100 m	100
RCL115/100/120	€ 117,00	115 mm x 100 m	120
RCL115/100/150	€ 117,00	115 mm x 100 m	150
RCL115/100/180	€ 117,00	115 mm x 100 m	180

RTFX**ROLOI DI TELA RESINATA**

Molto flessibile e resistente. Adatta per lavorare superfici sia piane che sagomate.



Corindone



Acciaio



Alluminio



Legno



Ghisa

Prep.
Superficie

Uniformare



A secco

Levigatrice
OrbitaleUtilizzo
Manuale

Art.	€	Dimensioni	Grana	Pack
RTF120/005/040	€ 7,20	115 mm x 5 m	40	10
RTF120/005/060	€ 7,20	115 mm x 5 m	60	10
RTF120/005/080	€ 7,20	115 mm x 5 m	80	10
RTF120/005/100	€ 7,20	115 mm x 5 m	100	10
RTF120/005/120	€ 7,20	115 mm x 5 m	120	10
RTF120/050/040	€ 59,00	115 mm x 50 m	40	10
RTF120/050/060	€ 59,00	115 mm x 50 m	60	10
RTF120/050/080	€ 59,00	115 mm x 50 m	80	10
RTF120/050/100	€ 59,00	115 mm x 50 m	100	10
RTF120/050/120	€ 59,00	115 mm x 50 m	120	10

RCSX**ROLOI DI CARTA STEARATA**

Rotoli al corindone, anti intasamento, ideale per superfici verniciate. Flessibile e resistente. L'aggiunta di stearato di zinco previene l'intasamento.



Corindone



Legno



Vernici



Stucchi



Compositi

Prep.
Superficie

Uniformare



A secco

Utilizzo
Manuale

Art.	€	Dimensioni	Grana
RCS115/050/150	€ 64,10	115 mm x 50 m	150
RCS115/050/180	€ 64,10	115 mm x 50 m	180
RCS115/050/240	€ 64,10	115 mm x 50 m	240
RCS115/050/320	€ 64,10	115 mm x 50 m	320
RCS115/050/400	€ 64,10	115 mm x 50 m	400
RCS115/050/600	€ 64,10	115 mm x 50 m	600

FLIX

CARTA LATTICE IMPERMEABILE

Carta supporto lattice al carburo di silicio di alta qualità, molto flessibile per finitura a secco o a umido. Per superfici verniciate, carrozzeria, elettronica, metalli preziosi, strumenti musicali, modellismo.

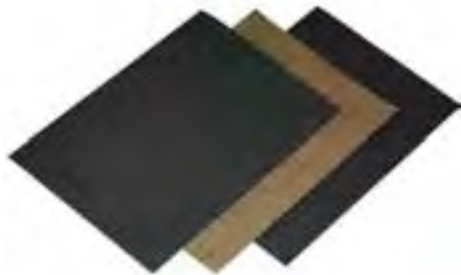

SPIXZ

ANELLI ABRASIVI RINFORZATI SPIRABANDS

Creati con strisce di tela abrasiva, avvolta e incollata su un supporto di cotone, ideali per la rettifica di alluminio o acciaio. Da utilizzare con i relativi portamanicotti in gomma. Per raggiungere parti difficilmente accessibili o mantenere le raggature.



SiC
Carburo di Silicio

F Finitura
A Acciaio
Al Alluminio
P Plastica
V Vernici
C Compositi
U Uniformare

H₂O Acqua
A A secco
S Smerigl. assiale
M Utilizzo Manuale

Art.	€	Dimensioni	Grana	Pack
FLI230/240	€ 0,60	230 x 280 mm	240	100
FLI230/320	€ 0,60	230 x 280 mm	320	100
FLI230/400	€ 0,60	230 x 280 mm	400	100
FLI230/600	€ 0,60	230 x 280 mm	600	100
FLI230/800	€ 0,60	230 x 280 mm	800	100
FLI230/1000	€ 0,60	230 x 280 mm	1000	100
FLI230/1200	€ 0,60	230 x 280 mm	1200	100

Zr
Zirconio

F Finitura
A Acciaio
In Inox
Al Alluminio
U Uniformare
A A secco
S Smerigl. assiale

Art.	€	Dimensioni	Grana	Max rpm	Pack
SPI1020/040Z	€ 0,31	10 x 20 mm	40	36000	100
SPI1020/060Z	€ 0,30	10 x 20 mm	60	36000	100
SPI1020/080Z	€ 0,30	10 x 20 mm	80	36000	100
SPI1020/120Z	€ 0,30	10 x 20 mm	120	36000	100
SPI1530/040Z	€ 0,43	15 x 30 mm	40	26000	100
SPI1530/060Z	€ 0,41	15 x 30 mm	60	26000	100
SPI1530/080Z	€ 0,41	15 x 30 mm	80	26000	100
SPI1530/120Z	€ 0,41	15 x 30 mm	120	26000	100
SPI2030/040Z	€ 0,51	20 x 30 mm	40	18000	100
SPI2030/060Z	€ 0,48	20 x 30 mm	60	18000	100
SPI2030/080Z	€ 0,48	20 x 30 mm	80	18000	100
SPI2030/120Z	€ 0,48	20 x 30 mm	120	18000	100
SPI2220/040Z	€ 0,41	22 x 20 mm	40	17000	100
SPI2220/060Z	€ 0,41	22 x 20 mm	60	17000	100
SPI2220/080Z	€ 0,41	22 x 20 mm	80	17000	100
SPI2220/120Z	€ 0,41	22 x 20 mm	120	17000	100
SPI2525/040Z	€ 0,55	25 x 25 mm	40	15000	100
SPI2525/060Z	€ 0,51	25 x 25 mm	60	15000	100
SPI2525/080Z	€ 0,51	25 x 25 mm	80	15000	100
SPI2525/120Z	€ 0,51	25 x 25 mm	120	15000	100
SPI3030/040Z	€ 0,60	30 x 30 mm	40	13000	100
SPI3030/060Z	€ 0,59	30 x 30 mm	60	13000	100
SPI3030/080Z	€ 0,59	30 x 30 mm	80	13000	100
SPI3030/120Z	€ 0,59	30 x 30 mm	120	13000	100
SPI4530/040Z	€ 0,82	45 x 30 mm	40	8500	100
SPI4530/060Z	€ 0,74	45 x 30 mm	60	8500	100
SPI4530/080Z	€ 0,74	45 x 30 mm	80	8500	100
SPI4530/120Z	€ 0,74	45 x 30 mm	120	8500	100

**SGCX****PORTAMANICOTTI**

Portamanicotti ad espansione, per il fissaggio dei manicotti abrasivi.

Smerigl.
assiale

Art.	€	Dimensioni	Gambo	Max rpm
SGC1020	€ 6,60	10 x 20 mm	6 mm	36000
SGC1530	€ 6,00	15 x 30 mm	6 mm	26000
SGC2030	€ 8,40	20 x 30 mm	6 mm	18000
SGC2220	€ 6,20	22 x 20 mm	6 mm	17000
SGC2525	€ 8,40	25 x 25 mm	6 mm	15000
SGC3030	€ 8,60	30 x 30 mm	6 mm	13300
SGC4530	€ 10,40	45 x 30 mm	6 mm	8500

CRDXT**RULLINI AVVOLTI**

Utensili di piccole dimensioni per operazioni di smerigliatura in punti di difficile accesso, può lavorare anche di punta. La tela avvolta su se stessa dà all'utensile una maggiore durata rispetto ai manicotti tradizionali. Utilizzo universale su acciaio, metalli non ferrosi e plastica.



A10x



Acciaio



Inox



Alluminio



Plastica



Ghisa



Sbavatura

Smerigl.
assiale

Art.	€	Dimensioni	Grana	Forma	Pack
CRD1038/060T	€ 0,77	10 x 38 mm	60	Conica	50
CRD1038/080T	€ 0,77	10 x 38 mm	80	Conica	50
CRD1038/120T	€ 0,77	10 x 38 mm	120	Conica	50
CRD1238/060T	€ 0,93	12 x 38 mm	60	Conica	50
CRD1238/080T	€ 0,93	12 x 38 mm	80	Conica	50
CRD1238/120T	€ 0,93	12 x 38 mm	120	Conica	50

CRDXC**RULLINI AVVOLTI**

Utensili di piccole dimensioni per operazioni di smerigliatura in punti di difficile accesso, può lavorare anche di punta. La tela avvolta su se stessa dà all'utensile una maggiore durata rispetto ai manicotti tradizionali. Utilizzo universale su acciaio, metalli non ferrosi e plastica.



A10x



Acciaio



Inox



Alluminio



Plastica



Ghisa



Sbavatura

Smerigl.
assiale

Art.	€	Dimensioni	Grana	Forma	Pack
CRD0638/060C	€ 0,51	6 x 38 mm	60	Cilindrica	50
CRD0638/080C	€ 0,51	6 x 38 mm	80	Cilindrica	50
CRD0638/120C	€ 0,51	6 x 38 mm	120	Cilindrica	50
CRD1038/040C	€ 0,68	10 x 38 mm	40	Cilindrica	50
CRD1038/060C	€ 0,68	10 x 38 mm	60	Cilindrica	50
CRD1038/080C	€ 0,68	10 x 38 mm	80	Cilindrica	50
CRD1038/120C	€ 0,68	10 x 38 mm	120	Cilindrica	50

PCR6338**€ 8,50****GAMBO PER RULLINI AVVOLTI**Smerigl.
assiale

NTXA

NASTRI ABRASIVI



NTXZ

NASTRI ABRASIVI

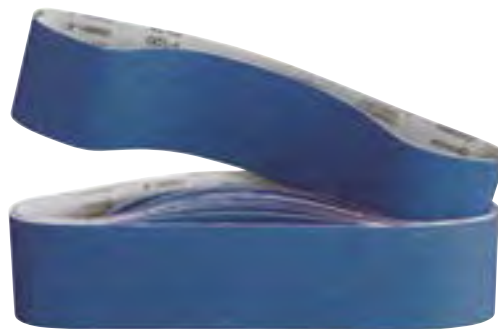

Art.	€	Dimensioni	Grana	Pack
NT0440/035/040A	€ 1,79	440 x 35 mm	40	10
NT0440/035/060A	€ 1,79	440 x 35 mm	60	10
NT0440/035/080A	€ 1,79	440 x 35 mm	80	10
NT0440/035/120A	€ 1,79	440 x 35 mm	120	10
NT0533/075/040A	€ 3,40	533 x 75 mm	40	10
NT0533/075/060A	€ 3,40	533 x 75 mm	60	10
NT0533/075/080A	€ 3,40	533 x 75 mm	80	10
NT0533/075/120A	€ 3,40	533 x 75 mm	120	10
NT0686/050/040A	€ 5,00	686 x 50 mm	40	10
NT0686/050/060A	€ 5,00	686 x 50 mm	60	10
NT0686/050/080A	€ 5,00	686 x 50 mm	80	10
NT0686/050/100A	€ 5,00	686 x 50 mm	100	10
NT0686/050/120A	€ 5,00	686 x 50 mm	120	10
NT0914/100/040A	€ 7,00	914 x 100 mm	40	10
NT0914/100/060A	€ 7,00	914 x 100 mm	60	10
NT0914/100/080A	€ 7,00	914 x 100 mm	80	10
NT0914/100/100A	€ 7,00	914 x 100 mm	100	10
NT0914/100/120A	€ 7,00	914 x 100 mm	120	10
NT1000/100/040A	€ 7,20	1000 x 100 mm	40	10
NT1000/100/060A	€ 7,20	1000 x 100 mm	60	10
NT1000/100/080A	€ 7,20	1000 x 100 mm	80	10
NT1000/100/120A	€ 7,20	1000 x 100 mm	120	10
NT1075/025/040A	€ 4,39	1075 x 25 mm	40	10
NT1075/025/060A	€ 4,39	1075 x 25 mm	60	10
NT1075/025/080A	€ 4,39	1075 x 25 mm	80	10
NT1075/025/100A	€ 4,39	1075 x 25 mm	100	10
NT1075/025/120A	€ 4,39	1075 x 25 mm	120	10
NT1219/152/040A	€ 7,90	1219 x 152 mm	40	10
NT1219/152/060A	€ 7,90	1219 x 152 mm	60	10
NT1219/152/080A	€ 7,90	1219 x 152 mm	80	10
NT1219/152/100A	€ 7,90	1219 x 152 mm	100	10
NT1219/152/120A	€ 7,90	1219 x 152 mm	120	10
NT1500/120/040A	€ 6,70	1500 x 120 mm	40	10
NT1500/120/060A	€ 6,70	1500 x 120 mm	60	10
NT1500/120/080A	€ 6,70	1500 x 120 mm	80	10
NT1500/120/120A	€ 6,70	1500 x 120 mm	120	10
NT1750/150/040A	€ 9,80	1750 x 150 mm	40	10
NT1750/150/060A	€ 9,80	1750 x 150 mm	60	10
NT1750/150/080A	€ 9,80	1750 x 150 mm	80	10
NT1750/150/120A	€ 9,80	1750 x 150 mm	120	10



Art.	€	Dimensioni	Grana	Pack
NT0330/010/040Z	€ 0,76	330 x 10 mm	40	10
NT0330/010/060Z	€ 0,66	330 x 10 mm	60	10
NT0330/010/080Z	€ 0,66	330 x 10 mm	80	10
NT0330/010/120Z	€ 0,66	330 x 10 mm	120	10
NT520/020/040Z	€ 1,02	520 x 20 mm	40	10
NT520/020/060Z	€ 0,87	520 x 20 mm	60	10
NT520/020/080Z	€ 0,77	520 x 20 mm	80	10
NT520/020/120Z	€ 0,68	520 x 20 mm	120	10
NT0610/100/040Z	€ 3,83	610 x 100 mm	40	10
NT0610/100/060Z	€ 3,37	610 x 100 mm	60	10
NT0610/100/080Z	€ 3,19	610 x 100 mm	80	10
NT0610/100/120Z	€ 3,13	610 x 100 mm	120	10
NT0760/040/040Z	€ 2,07	760 x 40 mm	40	10
NT0760/040/060Z	€ 1,79	760 x 40 mm	60	10
NT0760/040/080Z	€ 1,79	760 x 40 mm	80	10
NT0760/040/120Z	€ 1,79	760 x 40 mm	120	10
NT0914/100/040Z	€ 5,00	914 x 100 mm	40	10
NT0914/100/060Z	€ 4,81	914 x 100 mm	60	10
NT0914/100/080Z	€ 4,81	914 x 100 mm	80	10
NT0914/100/120Z	€ 4,81	914 x 100 mm	120	10
NT1000/100/040Z	€ 4,90	1000 x 100 mm	40	10
NT1000/100/060Z	€ 4,15	1000 x 100 mm	60	10
NT1000/100/080Z	€ 4,15	1000 x 100 mm	80	10
NT1000/100/120Z	€ 4,05	1000 x 100 mm	120	10
NT1219/152/040Z	€ 10,40	1219 x 152 mm	40	10
NT1219/152/060Z	€ 8,50	1219 x 152 mm	60	10
NT1219/152/080Z	€ 8,50	1219 x 152 mm	80	10
NT1219/152/120Z	€ 8,50	1219 x 152 mm	120	10
NT1500/120/040Z	€ 8,30	1500 x 120 mm	40	10
NT1500/120/060Z	€ 7,00	1500 x 120 mm	60	10
NT1500/120/080Z	€ 7,00	1500 x 120 mm	80	10
NT1500/120/120Z	€ 7,00	1500 x 120 mm	120	10
NT1750/150/040Z	€ 8,50	1750 x 150 mm	40	10
NT1750/150/060Z	€ 7,70	1750 x 150 mm	60	10
NT1750/150/080Z	€ 7,70	1750 x 150 mm	80	10
NT1750/150/120Z	€ 7,70	1750 x 150 mm	120	10
NT2000/050/040Z	€ 4,72	2000 x 50 mm	40	10
NT2000/050/060Z	€ 3,77	2000 x 50 mm	60	10
NT2000/050/080Z	€ 3,77	2000 x 50 mm	80	10
NT2000/050/120Z	€ 3,77	2000 x 50 mm	120	10
NT2000/150/040Z	€ 15,10	2000 x 150 mm	40	10
NT2000/150/060Z	€ 13,20	2000 x 150 mm	60	10
NT2000/150/080Z	€ 13,20	2000 x 150 mm	80	10
NT2000/150/120Z	€ 13,20	2000 x 150 mm	120	10



SURFACE CONDITIONING

SCDX

DISCHI LAMELLARI SURFACE CONDITIONING

Composto da lamelle di surface conditioning, finitura satinata, uniforme e controllata, ridotto sviluppo di calore, ridotto intasamento



Surface Cond.	Fibra di vetro	T27	Singola	EN 13743	Acciaio	Inox	Ghisa
Svernici.	Uniformare	0 - 15°	Smerigl. angolare	Made in REFLEX			

Art.	€	Dimensioni	Grana	Max rpm	Pack
SCD115/C	€ 6,50	Ø 115 x 22 mm	Coarse	13300	10
SCD115/M	€ 6,50	Ø 115 x 22 mm	Medium	13300	10
SCD115/VF	€ 6,50	Ø 115 x 22 mm	Very Fine	13300	10
SCD125/C	€ 8,00	Ø 125 x 22 mm	Coarse	12200	10
SCD125/M	€ 8,00	Ø 125 x 22 mm	Medium	12200	10
SCD125/VF	€ 8,00	Ø 125 x 22 mm	Very Fine	12200	10

SPA115/M14

€ 19,90

PLATORELLO DI SUPPORTO

Per dischi surface conditioning



M14	Smerigl. angolare

Diametro Ø	115 mm
Filetto	M14
Max rpm	13300

VSCX

DISCHI SURFACE CONDITIONING

Prodotto ideale per preparare le superfici alla verniciatura, per mascherare i difetti lasciando una finitura satinata e uniforme. rimuove ossidazioni, graffi, vernici, segni di saldatura.



Surface Cond.	Acciaio	Inox	Ghisa	Svernici.	Uniformare	Smerigl. angolare

Art.	€	Diametro Ø	Grana	Max rpm	Pack
VSC115/080C	€ 3,80	115 mm	Coarse (80)	5100	10
VSC115/120M	€ 3,80	115 mm	Medium (120)	5100	10
VSC115/240VF	€ 3,80	115 mm	Very Fine (240)	5100	10

MSCX

FAST LOCK SURFACE CONDITIONING

Rimuove ossidazioni, graffi, vernici, segni di saldatura.



Surface Cond.	Nylon	TR maschio	Acciaio	Inox	Ghisa	Svernici.	Uniformare	Smerigl. assiale

Art.	€	Diametro Ø	Grana	Max rpm	Pack
MSC050/C	€ 1,96	50 mm	Coarse	25000	10
MSC050/M	€ 1,96	50 mm	Medium	25000	10
MSC050/VF	€ 1,87	50 mm	Very Fine	25000	10
MSC075/C	€ 2,49	75 mm	Coarse	20000	25
MSC075/M	€ 2,49	75 mm	Medium	20000	25
MSC075/VF	€ 2,49	75 mm	Very Fine	20000	25

PARX

ROTOLI NON TESSUTO

Composti di fibra sintetica non tessuta, unita a particelle di grana abrasiva tramite resina. Resistenti ad acqua e lubrificanti, adatti per satinare, levigare, rimuovere residui di vernice o graffi, impiegati in settori diversi: metallo, legno, vernici, materie plastiche, ceramica



FPA120-

FOGLI IN PANNO ABRASIVO

Composti di fibra sintetica non tessuta, unita a particelle di grana abrasiva tramite resina. Resistenti ad acqua e lubrificanti, adatti per satinare, levigare, rimuovere residui di vernice o graffi, impiegati in settori diversi: metallo, legno, vernici, materie plastiche, ceramica



Art.	€	Dimensioni	Grana
PAR115/120AM	€ 41,10	115 mm x 10 m	A.Medium (120)
PAR115/180AF	€ 41,10	115 mm x 10 m	A.Fine (180)
PAR115/320AVF	€ 41,10	115 mm x 10 m	A.Very Fine (320)
PAR115/600AUF	€ 41,10	115 mm x 10 m	A.Ultra Fine (600)



Art.	€	Dimensioni	Grana	Pack
FPA120/M	€ 1,68	115 x 280 mm	A.Medium (120)	10
FPA120/F	€ 1,68	115 x 280 mm	A.Fine (180)	10
FPA120/VF	€ 1,68	115 x 280 mm	A.Very Fine (320)	10
FPA120/UF	€ 1,68	115 x 280 mm	S.Ultra Fine (600)	10





CLEAN STRIP

CSCD-

DISCHI IN NYLON ABRASIVO

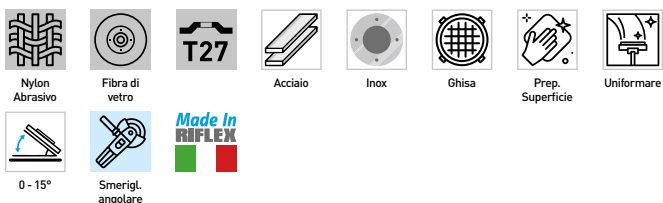

Art.	€	Dimensioni	Max rpm	Pack
CSCD/F115	€ 6,20	115 x 22 mm	11000	5
CSCD/F180	€ 9,00	180 x 22 mm	7000	5
CSCD/F115HD	€ 6,80	115 x 22 mm	11000	5

ADF-

ALBERINI DI FISSAGGIO

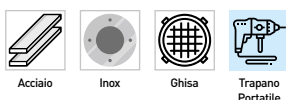

Art.	€	Dimensioni	Tipo	Pack
ADF/01	€ 1,96	10 x 6 mm	25	10
ADF/02	€ 2,05	12,8 x 8 mm	24	10

CSDS-

DISCHI PIANI CON FORO PER TRAPANO

Dischi piani con foro per trapano



Art.	€	Diametro	Max rpm
CSDS/100	€ 4,11	100 mm	8000
CSDS/150	€ 6,70	150 mm	5350
CSDS/200	€ 10,30	200 mm	4000

CSF-

BLACK CLEANER IN NYLON ABRASIVO

Attacco rapido. per rimuovere ruggine, vernice, colle, ossidazioni, calamine.

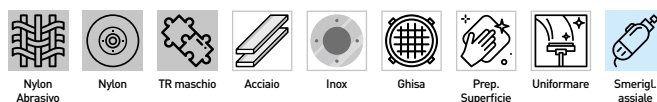

Art.	€	Diametro Ø	Max rpm	Pack
CSF/050	€ 2,93	50 mm	12000	10
CSF/075	€ 4,51	75 mm	8000	10



UNCD-

DISCHI NON-WOVEN PER FINITURA

Dischi in tessuto non tessuto abrasivo compresso ed imbevuto di resina.



Art.	€	Dimensioni	Grana	Max rpm	Pack
UNCD/F115F	€ 14,50	115 x 22 mm	S/C-F	11000	5
UNCD/F115M	€ 14,50	115 x 22 mm	S/C-M	11000	5
UNCD/F115C	€ 14,50	115 x 22 mm	A/O-C	11000	5



UNPX

DISCO NON TESSUTO COMPRESSO

Lo spessore sottile permette di svolgere la finitura e la pulizia degli angoli interni con smerigliatrici angolari a basso numero di giri. il prodotto deve lavorare di testa, non esercitare pressioni laterali



Art.	€	Diametro Ø	Spessore	Foro	Grana	Max rpm	Pack
UNP115/6/3SF	€ 11,20	115 mm	6 mm	22 mm	3 S.Fine	5000	5
UNP115/6/6SM	€ 13,00	115 mm	6 mm	22 mm	6 S.Medium	5000	5
UNP125/6/3SF	€ 13,00	125 mm	6 mm	22 mm	3 S.Fine	5000	5
UNP125/6/6SM	€ 15,10	125 mm	6 mm	22 mm	6 S.Medium	5000	5



UNFX

DISCO NON TESSUTO COMPRESSO

3am durezza media, grana media. sbavatura di piccole bave, mascheratura di passaggi precedenti con l'abrasivo, rimozione ossidazioni. 6ac dura, grana grossa. sbavatura, mascheratura di graffi profondi lasciati dall'abrasivo, rimozione di ossidazioni. 6sf molto dura, grana fine. si adatta meno alla sagoma del pezzo ma dura di più ed è più resistente in presenza di leggere bave.



Art.	€	Diametro Ø	Spessore	Foro	Grana	Max rpm	Pack
UNF150/6/3AM	€ 18,50	150 mm	6 mm	25 mm	3 A.Medium	5000	5
UNF150/6/6SF	€ 18,70	150 mm	6 mm	25 mm	6 S.Fine	5000	5
UNF150/6/6AC	€ 22,00	150 mm	6 mm	25 mm	6 A.Coarse	5000	5

MDUX

FAST LOCK UNITIZED

Sbavatura e finitura di bordi e angoli, saldature, rimozione di graffi e ossidazioni leggere.

Finitura superficiale di qualità superiore.



Art.	€	Diametro Ø	Grana	Max rpm
MDU075/2SF	€ 10,40	75 mm	2SF	20000
MDU075/6SF	€ 11,90	75 mm	6SF	20000
MDU075/6AM	€ 14,00	75 mm	6AM	20000



PAS-

PASTE ABRASIVE

Bianca: pasta grassa per accompagnare la sgrossatura ed il primo passaggio con sisal, tampico, filo di acciaio o filo di nylon. per ottone, argento, zama, inox. azzurra: pasta medio grassa per taglio fine, brillantatura, secondo passaggio. accompagna i dischi in cotone su acciaio, zama, ottone. rosa: pasta medio/grassa per lucidare e brillantare; accompagna la tela nel secondo passaggio e nella lucidatura di ottone, argento, alluminio, cromo e zama. verde: pasta medio grassa per accompagnare il sisal nella finitura dell'inox. gialla: molto tagliente per eliminare graffi da preziosi argenteria.



Art.	€	Colore
PAS/W	€ 6,40	Bianco
PAS/B	€ 8,50	Blu
PAS/P	€ 8,20	Rosa
PAS/Y	€ 7,20	Giallo
PAS/G	€ 6,90	Verde

DLFX

DISCHI LAMELLARI IN FELTRO

Per la lucidatura a specchio accompagnata da pasta abrasiva o compound, le lamelle in feltro sono flessibili e aiutano a prevenire il surriscaldamento.



Art.	€	Dimensioni	Max rpm	Pack
DLF115	€ 4,94	Ø 115 x 22 mm	6000	10
DLF125	€ 5,80	Ø 125 x 22 mm	6000	10

S169

€ 9,40

SET PASTE PER LUCIDATURA METALLI

Verde e rosa: pasta per l'esecuzione di lucidature di finitura sulle principali categorie di metalli. Marrone e nero: Per l'esecuzione di lucidature di finitura grossa/media su materiali come ottone, alluminio e zinco. Bianca: per l'esecuzione di lucidature di finitura grossa/media su materiali come ferro, inox e rame.



MDFX

FAST LOCK FELTRO

Per la lucidatura a specchio accompagnata da pasta abrasiva o compound



Art.	€	Diametro Ø	Max rpm	Pack
MDF050	€ 2,64	50 mm	25000	10
MDF075	€ 3,63	75 mm	20000	10

RGFX

RUOTE LAMELLARI IN FELTRO

Per la lucidatura a specchio accompagnata da pasta abrasiva o compound. le lamelle in feltro sono flessibili e aiutano a prevenire il surriscaldamento oltre ad adattarsi alla superficie da lavorare, garantendo un impatto morbido e controllato.



Art.	€	Diametro Ø	Spessore	Gambo	Max rpm	Pack
RGF030/30	€ 4,94	30 mm	30 mm	6 mm	12500	10
RGF040/30	€ 5,50	40 mm	30 mm	6 mm	9500	10
RGF050/30	€ 6,30	50 mm	30 mm	6 mm	7500	10
RGF060/30	€ 6,90	60 mm	30 mm	6 mm	6000	10
RGF080/30	€ 9,30	80 mm	30 mm	6 mm	4500	10

DFFX

DISCHI IN FELTRO

Per pulitura e lucidatura a specchio. velocità raccomandata 5-10 m/s



Art.	€	Diametro ø	Spessore	Foro
DFF100/13	€ 6,40	100 mm	13 mm	10 mm
DFF150/13	€ 11,40	150 mm	13 mm	15 mm
DFF150/25	€ 20,60	150 mm	25 mm	15 mm
DFF200/13	€ 17,60	200 mm	13 mm	15 mm
DFF200/25	€ 36,00	200 mm	25 mm	15 mm

VDFX

DISCO VELCRATO IN FELTRO

Per pulitura e lucidatura a specchio. Da usare con pasta abrasiva o diamantata.



Art.	€	Diametro ø	Spessore	Max rpm	Pack
VDF075	€ 3,86	75 mm	5 mm	6000	10
VDF115	€ 4,50	115 mm	5 mm	4000	10
VDF125	€ 5,10	125 mm	5 mm	3500	10
VDF150	€ 7,10	150 mm	5 mm	3000	10
VDF180	€ 9,40	180 mm	5 mm	2500	10

MFGX

FELTRINI SU GAMBO

Per pulitura e lucidatura a specchio. si usano per lucidare gli stampi, accompagnati da pasta diamantata. velocità raccomandata 5-10 m/s.

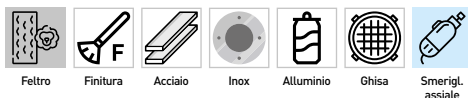

Art.	€	Forma	Diametro ø	Spessore	Gambo	Pack
MFG0610/03A	€ 1,28	A	6 mm	10 mm	3 mm	10
MFG0810/03A	€ 1,28	A	8 mm	10 mm	3 mm	10
MFG1014/06A	€ 1,34	A	10 mm	14 mm	6 mm	10
MFG1520/06A	€ 1,43	A	15 mm	20 mm	6 mm	10
MFG0812/03K	€ 1,35	K	8 mm	12 mm	3 mm	10
MFG1018/06K	€ 1,43	K	10 mm	18 mm	6 mm	10
MFG1530/06K	€ 2,45	K	15 mm	30 mm	6 mm	10
MFG1530/06C	€ 2,44	C	15 mm	30 mm	6 mm	10
MFG2025/06C	€ 2,58	C	20 mm	25 mm	6 mm	10
MFG2530/06C	€ 3,86	C	25 mm	30 mm	6 mm	10
MFG2025/06L	€ 2,49	L	20 mm	25 mm	6 mm	10
MFG2530/06L	€ 3,38	L	25 mm	30 mm	6 mm	10



DFC115/M14

€ 18,00

DISCO IN FELTRO CONICO

Per pulitura e lucidatura a specchio. da usare con pasta abrasiva o diamantata



Diametro ø	115 mm
Spessore	12 mm
Filetto	M14
Max rpm	12500

RFF100

€ 54,60

RUOTA CON FORO IN FELTRO

Per pulitura e lucidatura a specchio. da usare con pasta abrasiva o diamantata

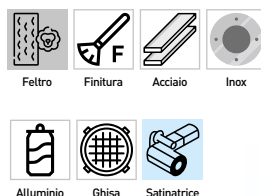

Dimensioni	110 x 100 mm
Diametro foro	19 mm



DCK100

€ 4,42

DISCHETTI IN COTONE VENTILATI

Per la lucidatura a specchio di inox, rame, ottone, alluminio. 10 dischi per comporre un blocco di spessore 100 mm



Diametro ø	100 mm
Foro	19,1 mm
Pack	10

DSK100

€ 7,00

DISCHETTI IN SISAL E COTONE

Per eliminare i segni dell'abrasivo e preparare la superficie per la lucidatura con panno o feltro. 7 dischi per comporre un blocco di spessore 100 mm

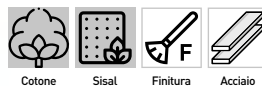

Diametro ø	100 mm
Foro	19,1 mm
Pack	10

DCTX

DISCHI IN COTONE TRAPUNTATO

Dischi in cotone cuciti tra loro. da usare con pasta abrasiva per lucidare.



Art.	€	Diametro ø	Foro
DCT150	€ 4,85	150 mm	12 mm
DCT200	€ 7,70	200 mm	20 mm
DCT250	€ 14,10	250 mm	20 mm

DSCX

DISCHI IN SISAL E COTONE

Per eliminare i segni dell'abrasivo e preparare la superficie per la lucidatura con panno o feltro. accompagnare con pasta abrasiva.



Art.	€	Diametro ø	Foro
DSC150	€ 6,40	150 mm	20 mm
DSC200	€ 12,40	200 mm	20 mm
DSC250	€ 15,80	250 mm	20 mm

DSTX

DISCHI TRAPUNTATI IN SISAL

Per eliminare i segni dell'abrasivo e preparare la superficie per la lucidatura con panno o feltro. accompagnare con pasta abrasiva.



Art.	€	Diametro ø	Foro
DST150	€ 6,60	150 mm	20 mm
DST200	€ 13,00	200 mm	20 mm
DST250	€ 18,90	250 mm	20 mm

DCVX

DISCHI VENTILATI

Dischi ventilati in cotone



Art.	€	Diametro ø	Foro	Falde
DCV150	€ 4,26	150 mm	20 mm	8
DCV200	€ 11,40	200 mm	20 mm	16

DMV150

€ 4,94

DISCHI VENTILATI

Dischi ventilati in sisal e cotone



Diametro ø	150 mm
Foro	20 mm
Falde	2

DC200

€ 21,60

DISCHI ONDULATI

In cotone con nucleo di cartone.



Diametro ø	200 mm
Foro	20 mm
Falde	14

DNW100

€ 2,80

DISCO NON TESSUTO BIANCO



Diametro ø	100 mm
Foro	10 mm
Pack	10

DCGX

DISCHI IN COTONE CON GAMBO

Per lucidare, da usare con la pasta abrasiva. velocità periferica ottimale 5-10 m/s



Art.	€	Diametro ø	Spessore	Gambo	Pack
DCG050	€ 3,49	50 mm	12 mm	6 mm	10
DCG080	€ 4,41	80 mm	12 mm	6 mm	10
DCG100	€ 5,30	100 mm	12 mm	6 mm	10

FCGX

COTONE A FUNGO CON GAMBO



Art.	€	Diametro ø	Gambo	Pack
FCG50	€ 4,24	50 mm	6 mm	10
FCG75	€ 6,40	75 mm	6 mm	10

CCGX

CONO DI COTONE

Per lucidare, da usare con la pasta abrasiva. velocità periferica ottimale 5-10 m/s.



Art.	€	Diametro ø	Gambo	Pack
CCG50	€ 6,30	50 mm	6 mm	5
CCG75	€ 9,80	75 mm	6 mm	5



PNS € 2,14

PERNO

Perno per dischi DNW



Smerigl
assiale



PLV175 € 25,60

PLATORELLO PER DISCHI IN LANA

Platorello di supporto specifico per VLA200.



M14 Levigatrice
Orbitale



Diametro ø	175 mm
Filetto	M14

VSPX

PLATORELLI IN POLIURETANO

Platorelli morbidi ad alto e medio profilo per la lucidatura dei bordi. pur molded, morbido, buon rimbalzo e durata. ideale per lucidatura frontale dell'auto, pezzi in fibra di vetro, barca, pavimenti ecc. consigliato per lavorare con dischi in lana, spugna e dischi abrasivi.



M14 Levigatrice
Orbitale



Art.	€	Diametro ø	Filetto	Max rpm
VSP075	€ 8,90	75 mm	M14	12200
VSP115	€ 9,70	115 mm	M14	10000
VSP125	€ 10,10	125 mm	M14	10000
VSP150	€ 11,60	150 mm	M14	7000
VSP180	€ 12,20	180 mm	M14	5000

VLA200 € 19,00

DISCO IN LANA ATTORCIGLIATA

Per lucidare superfici verniciate e marmo



Diametro ø	200 mm
------------	--------

VDLX

DISCHI IN LANA VELCRATI

Disco in lana merinos per lucidare superfici verniciate, con attacco velcrato.



Art.	€	Diametro ø
VDL075	€ 5,80	75 mm
VDL115	€ 7,10	115 mm
VDL125	€ 8,00	125 mm
VDL150	€ 9,70	150 mm
VDL180	€ 12,20	180 mm



BSAX

BLOCCHETTI DI SPUGNA ABRASIVA

Spugna semirigida, si adatta alla sagoma della superficie da lavorare e mantiene la forma piana sui quattro lati. impiegato nella lavorazione del legno, per porte e finestre, per angoli e scanalature. si può usare a secco e ad umido e si può risciacquare dopo l'uso.



FSAX

FOGLI DI SPUGNA ABRASIVA

Molto flessibile, si adatta alla sagoma della superficie da lavorare. impiegato nella lavorazione del legno, nell'industria del mobile, nelle carrozzerie. si può usare a secco e ad umido e si può risciacquare dopo l'uso.



Art.	€	Dimensioni	Grana	Pack
BSA100/060C	€ 0,90	98 x 69 x 26 mm	Coarse (60)	20
BSA100/100M	€ 0,90	98 x 69 x 26 mm	Medium (100)	20
BSA100/180F	€ 0,90	98 x 69 x 26 mm	Fine (180)	20



Art.	€	Dimensioni	Grana	Pack
FSA120/060C	€ 0,84	120 x 98 x 13 mm	Coarse (60)	20
FSA120/100M	€ 0,84	120 x 98 x 13 mm	Medium (100)	20
FSA120/180F	€ 0,84	120 x 98 x 13 mm	Fine (180)	20

BGAX

BLOCCHETTI IN GOMMA

Utilizzabili per varie operazioni di pulizia e finitura manuale



SALX

SPUGNE PER LUCIDARE

Disponibile in diverse durezze e porosità, per accompagnare le varie paste nelle fasi di lucidatura. giallo: prima lucidatura, durezza media, porosa blu: prima lucidatura, durezza media, fine arancione: lucidatura, durezza media, fine bianco: lucidatura, morbido, fine nera: super morbido, fine, lucidatura finale



Art.	€	Dimensioni	Grana
BGA8050/036	€ 9,20	80 x 50 x 20 mm	36
BGA8050/060	€ 9,20	80 x 50 x 20 mm	60
BGA8050/120	€ 9,20	80 x 50 x 20 mm	120
BGA8050/240	€ 9,20	80 x 50 x 20 mm	240



Art.	€	Diametro Ø	Spessore	Colore	Max rpm
SAL80Y	€ 4,75	80 mm	25 mm	Giallo	8000
SAL80B	€ 3,59	80 mm	25 mm	Blu	8000
SAL800	€ 3,57	80 mm	25 mm	Arancione	8000
SAL80K	€ 3,37	80 mm	25 mm	Nero	8000
SAL150Y	€ 13,10	150 mm	50 mm	Giallo	4500
SAL150B	€ 10,20	150 mm	50 mm	Blu	4500
SAL1500	€ 9,90	150 mm	50 mm	Arancione	4500
SAL150K	€ 8,20	150 mm	50 mm	Nero	4500



SRFX

SPAZZOLA CIRCOLARE CON FILI ONDOLATI

Per spazzolatura fatta con macchine stazionarie e mole da banco. per applicazioni medie e gravose: lunga vita, aggressive, molto resistenti



Art.	€	Dimensioni	Foro	Filo	Max rpm
SRF125/25	€ 7,00	Ø 125 x 20 mm	16, 12,7 mm	0,3 mm	6000
SRF150/25	€ 8,50	Ø 150 x 32 mm	25, 22, 20, 16, 12,7 mm	0,3 mm	6000
SRF175/25	€ 9,70	Ø 175 x 32 mm	25, 22, 20, 16 mm	0,3 mm	6000
SRF200/25	€ 12,10	Ø 200 x 32 mm	25, 22, 20, 16 mm	0,3 mm	4500
SRF250/25	€ 23,20	Ø 250 x 32 mm	25, 22, 20, 16 mm	0,3 mm	3000

SRFXI

SPAZZOLA CIRCOLARE CON FILI ONDOLATI

Per spazzolatura fatta con macchine stazionarie e mole da banco. per applicazioni medie e gravose: lunga vita, aggressive, molto resistenti

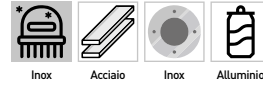

Art.	€	Dimensioni	Foro	Filo	Max rpm
SRF125/25I	€ 12,50	Ø 125 x 20 mm	16, 12,7 mm	0,3 mm	6000
SRF150/25I	€ 15,40	Ø 150 x 32 mm	25, 22, 20, 16, 12,7 mm	0,3 mm	6000
SRF175/25I	€ 18,40	Ø 175 x 32 mm	25, 22, 20, 16 mm	0,3 mm	6000
SRF200/25I	€ 22,50	Ø 200 x 32 mm	25, 22, 20, 16 mm	0,3 mm	4500
SRF250/25I	€ 34,50	Ø 250 x 32 mm	25, 22, 20, 16 mm	0,3 mm	3000

STFX

SPAZZOLA A TAZZA A FILI ONDOLATI

Per l'uso con smerigliatrici angolari, per bave, adatta a spazzolare grandi superfici.

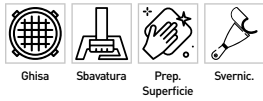
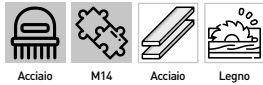

Art.	€	Diametro ø	Filetto	Filo	Max rpm
STF060	€ 3,45	60 mm	M14	0,3 mm	12500
STF080	€ 4,09	80 mm	M14	0,3 mm	11000
STF100	€ 6,00	100 mm	M14	0,3 mm	8500
STF120	€ 10,70	120 mm	M14	0,3 mm	6500

STFXI

SPAZZOLA A TAZZA A FILI ONDOLATI

Per l'uso con smerigliatrici angolari, per bave, adatta a spazzolare grandi superfici.



Art.	€	Diametro ø	Filetto	Filo	Max rpm
STF060I	€ 6,10	60 mm	M14	0,3 mm	12500
STF080I	€ 7,60	80 mm	M14	0,3 mm	11000
STF100I	€ 10,70	100 mm	M14	0,3 mm	8500
STF120I	€ 15,70	120 mm	M14	0,3 mm	6500

SCFX

SPAZZOLA CONICA A FILI ONDOLATI

Per l'uso con smerigliatrici angolari.



Art.	€	Filetto	Filo	Max rpm	Diametro ø
SCF090	€ 4,00	M14	0,3 mm	125000	90 mm
SCF120	€ 5,40	M14	0,3 mm	125000	120 mm
SCF150	€ 10,50	M14	0,3 mm	6500	150 mm

SCFXI

SPAZZOLA CONICA A FILI ONDOLATI

Per l'uso con smerigliatrici angolari.

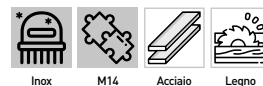

Art.	€	Filetto	Filo	Max rpm	Diametro ø
SCF090I	€ 6,00	M14	0,3 mm	125000	90 mm
SCF120I	€ 8,10	M14	0,3 mm	12500	120 mm
SCF150I	€ 15,70	M14	0,3 mm	6000	150 mm

SRRX

SPAZZOLA CIRCOLARE A MAZZETTI RITORTI

Per lavorazioni gravose, pulizia cordoni di saldatura, per ottenere una superficie con tracce più evidenti.

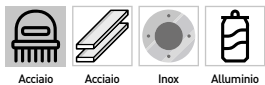

Art.	€	Diametro ø	Foro	Filo	Max rpm
SRR100	€ 6,20	100 mm	22 mm	0,5 mm	12500
SRR150	€ 12,10	150 mm	22 mm	0,5 mm	9000
SRR200	€ 17,30	200 mm	22 mm	0,5 mm	6000

SRRX-M14

SPAZZOLA CIRCOLARE A MAZZETTI RITORTI

Per lavorazioni gravose, pulizia cordoni di saldatura, per ottenere una superficie con tracce più evidenti.

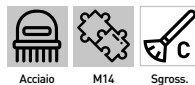

Art.	€	Diametro ø	Filetto	Filo	Max rpm
SRR100/M14	€ 6,10	100 mm	M14	0,5 mm	12500
SRR115/M14	€ 7,50	115 mm	M14	0,5 mm	12500
SRR125/M14	€ 9,00	125 mm	M14	0,5 mm	11000

STRX

SPAZZOLA A TAZZA A MAZZETTI RITORTI

Per la lavorazione di grandi superfici, per eliminare la calamina, la vernice, la ruggine.

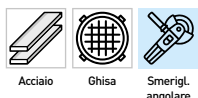
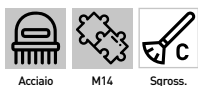

Art.	€	Diametro ø	Filetto	Filo	Max rpm
STR065	€ 6,80	65 mm	M14	0,5 mm	12500
STR075	€ 7,90	75 mm	M14	0,5 mm	8500
STR080	€ 9,20	80 mm	M14	0,5 mm	8500
STR100	€ 12,10	100 mm	M14	0,5 mm	8500
STR120	€ 15,70	120 mm	M14	0,5 mm	6500

STRXI

SPAZZOLA A TAZZA A MAZZETTI RITORTI

Per la lavorazione di grandi superfici, per eliminare la calamina, la vernice, la ruggine.



Art.	€	Diametro ø	Filetto	Filo	Max rpm
STR065I	€ 9,80	65 mm	M 14	0,5 mm	12500
STR075I	€ 12,20	75 mm	M 14	0,5 mm	8500
STR080I	€ 16,30	80 mm	M 14	0,5 mm	8500
STR100I	€ 19,10	100 mm	M 14	0,5 mm	8500
STR120I	€ 24,70	120 mm	M 14	0,5 mm	6500

SCRX

SPAZZOLA CONICA A MAZZETTI RITORTI

Per la lavorazione di grandi superfici, per eliminare la calamina, la vernice, la ruggine. indicata per raggiungere meglio gli angoli.



Art.	€	Diametro ø	Filetto	Filo	Max rpm
SCR100	€ 6,50	100 mm	M14	0,5 mm	12500
SCR120	€ 9,20	120 mm	M14	0,5 mm	12500

SCRXI

SPAZZOLA CONICA A MAZZETTI RITORTI

Per la lavorazione di grandi superfici, per eliminare la calamina, la vernice, la ruggine. indicata per raggiungere meglio gli angoli.



Art.	€	Diametro ø	Filetto	Filo	Max rpm
SCR100I	€ 9,80	100 mm	M14	0,5 mm	12500
SCR120I	€ 13,70	120 mm	M14	0,5 mm	12500



SRGX

SPAZZOLA CIRCOLARE CON GAMBO

Per pulizia di saldature, per leggere bave, sverniciature, calamine, ruggine.



Art.	€	Diametro ø	Spessore	Gambo	Filo	Max rpm
SRG030/05	€ 0,97	30 mm	5 mm	6 mm	0,3 mm	4500
SRG040/05	€ 1,07	40 mm	5 mm	6 mm	0,3 mm	4500
SRG050/06	€ 1,30	50 mm	6 mm	6 mm	0,3 mm	4500
SRG060/06	€ 1,49	60 mm	6 mm	6 mm	0,3 mm	4500
SRG070/08	€ 1,74	70 mm	8 mm	6 mm	0,3 mm	4500
SRG080/08	€ 1,90	80 mm	8 mm	6 mm	0,3 mm	4500
SRG100/10	€ 2,05	100 mm	10 mm	6 mm	0,3 mm	4500
SRG100/15	€ 3,33	100 mm	15 mm	6 mm	0,3 mm	4500

SRGXI

SPAZZOLA CIRCOLARE CON GAMBO

Per pulizia di saldature, per leggere bave, sverniciature, calamine, ruggine.



Art.	€	Diametro ø	Spessore	Gambo	Filo	Max rpm
SRG030/05I	€ 1,60	30 mm	5 mm	6 mm	0,3 mm	4500
SRG040/05I	€ 1,72	40 mm	5 mm	6 mm	0,3 mm	4500
SRG050/06I	€ 2,24	50 mm	6 mm	6 mm	0,3 mm	4500
SRG060/06I	€ 2,34	60 mm	6 mm	6 mm	0,3 mm	4500
SRG070/08I	€ 2,71	70 mm	8 mm	6 mm	0,3 mm	4500
SRG080/08I	€ 3,76	80 mm	8 mm	6 mm	0,3 mm	4500
SRG100/10I	€ 4,09	100 mm	10 mm	6 mm	0,3 mm	4500
SRG100/15I	€ 5,50	100 mm	15 mm	6 mm	0,3 mm	4500

SNGX

SPAZZOLA CIRCOLARE IN NYLON CON GAMBO

Più flessibile e resistente alla rottura del filo d'acciaio. Sui metalli rimuove l'ossido e i residui di vernice graffiando meno ed evitando la ruggine, sui legni prepara la superficie.



Art.	€	Diametro ø	Gambo	Grana	Colore	Max rpm
SNG075/080R	€ 5,80	75 mm	6 mm	80	Rosso	4500
SNG075/180B	€ 5,80	75 mm	6 mm	180	Blu	4500
SNG100/080R	€ 6,70	100 mm	6 mm	80	Rosso	4500
SNG100/180B	€ 6,90	100 mm	6 mm	180	Blu	4500

SGR075

€ 3,86

SPAZZOLA CON GAMBO A MAZZETTI RITORTI

Per pulire, eliminare ruggine, per cordoni di saldatura.



Diametro ø	75 mm
Gambo	6 mm
Filo	0,5 mm
Max rpm	12000

SGR075I

€ 4,86

SPAZZOLA CON GAMBO A MAZZETTI RITORTI

Per pulire, eliminare ruggine, per cordoni di saldatura.

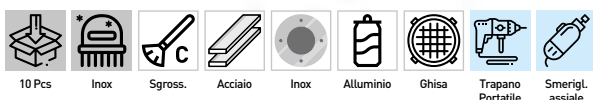

Diametro ø	75 mm
Gambo	6 mm
Filo	0,5 mm
Max rpm	12000

SCG090

€ 4,09

SPAZZOLA CONICA CON GAMBO

Per pulizia di punti difficili da raggiungere di saldature, per leggere bave, sverniciature, calamine, ruggine.



Diametro ø	90 mm
Gambo	6 mm
Filo	0,3 mm
Max rpm	12500

SCG090I

€ 5,90

SPAZZOLA CONICA CON GAMBO

Per pulizia di punti difficili da raggiungere di saldature, per leggere bave, sverniciature, calamine, ruggine.



Diametro ø	90 mm
Gambo	6 mm
Filo	0,3 mm
Max rpm	12500

STGX

SPAZZOLA A TAZZA CON GAMBO

Per pulizia frontale di saldature, per leggere bave, sverniciature, calamine, ruggine.



Art.	€	Diametro ø	Gambo	Filo	Max rpm
STG050I	€ 2,45	50 mm	6 mm	0,3 mm	6500
STG070I	€ 3,12	70 mm	6 mm	0,3 mm	4500

SFGXI

SPAZZOLA FRONTALE

Per lavorazioni frontali e in aree di difficile accesso.



Art.	€	Diametro ø	Gambo	Filo	Max rpm
SFG010I	€ 1,78	10 mm	6 mm	0,3 mm	20000
SFG015I	€ 2,51	15 mm	6 mm	0,3 mm	20000
SFG020I	€ 3,09	20 mm	6 mm	0,3 mm	20000
SFG025I	€ 3,33	25 mm	6 mm	0,3 mm	20000
SFG030I	€ 4,94	30 mm	6 mm	0,3 mm	20000

STGX

SPAZZOLA A TAZZA CON GAMBO

Per pulizia frontale di saldature, per leggere bave, sverniciature, calamine, ruggine.



Art.	€	Diametro ø	Gambo	Filo	Max rpm
STG050	€ 1,61	50 mm	6 mm	0,3 mm	6500
STG070	€ 2,08	70 mm	6 mm	0,3 mm	4500

SFGX

SPAZZOLA FRONTALE

Per lavorazioni frontali e in aree di difficile accesso.



Art.	€	Diametro ø	Gambo	Filo	Max rpm
SFG010	€ 1,37	10 mm	6 mm	0,3 mm	20000
SFG015	€ 1,80	15 mm	6 mm	0,3 mm	20000
SFG020	€ 2,24	20 mm	6 mm	0,3 mm	20000
SFG025	€ 2,52	25 mm	6 mm	0,3 mm	20000
SFG030	€ 3,33	30 mm	6 mm	0,3 mm	20000

SFPX

SPAZZOLA FRONTALE A PUNTA

Per lavorazioni frontali e in aree di difficile accesso.



Art.	€	Diametro ø	Gambo	Filo	Max rpm
SFP012	€ 2,12	12 mm	6 mm	0,3 mm	20000
SFP024	€ 3,09	24 mm	6 mm	0,3 mm	20000



SFPXI

SPAZZOLA FRONTALE A PUNTA

Per lavorazioni frontali e in aree di difficile accesso.



Art.	€	Diametro ø	Gambo	Filo	Max rpm
SFP012I	€ 1,60	12 mm	6 mm	0.3 mm	20000
SFP024I	€ 3,87	24 mm	6 mm	0.3 mm	20000

SFRX

SPAZZOLA FRONTALE A MAZZETTI RITORTI

Per lavorazioni frontali e in aree di difficile accesso.



Art.	€	Diametro ø	Gambo	Filo	Max rpm
SFR019	€ 4,15	19 mm	6 mm	0,5 mm	20000
SFR022	€ 4,57	22 mm	6 mm	0,5 mm	20000

SFRXI

SPAZZOLA FRONTALE A MAZZETTI RITORTI

Per lavorazioni frontali e in aree di difficile accesso.

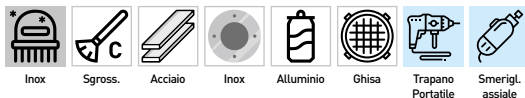

Art.	€	Diametro ø	Gambo	Filo	Max rpm
SFR019I	€ 6,40	19 mm	6 mm	0,5 mm	20000
SFR022I	€ 7,00	22 mm	6 mm	0,5 mm	20000

0331

€ 31,50

SET SPAZZOLE PER L'OFFICINA E L'AUTORIPARATORE

Con prolunga e manico in plastica



Misure Ø 9 - 11 - 13 - 15 - 17 - 19 mm
 Materiale Nylon - Acciaio - Ottone

SMC275

€ 1,67

SPAZZOLA A MANO

Per svariate operazioni di pulizia manuale



Misura 275 mm

SMC275I

€ 3,36



SPAZZOLA A MANO

Per svariate operazioni di pulizia manuale

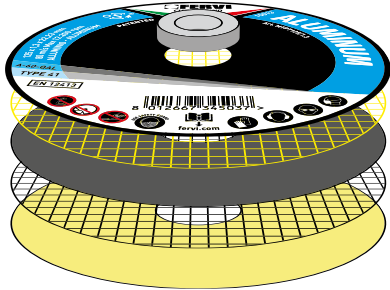

Misura 275 mm

COSTRUZIONE DEL DISCO

<p>Un disco abrasivo è costituito da grani abrasivi (~75%) legati insieme con resine (~25%) e reti in fibra di vetro per aumentare la resistenza del prodotto. I minerali usati nella produzione degli abrasivi vengono scelti sulla base della loro durezza, tenacità, resistenza al calore, composizione e forma del grano da cui dipende la capacità di taglio propria di quell'abrasivo.</p>	
<p>Gli abrasivi comunemente utilizzati nella produzione di un disco abrasivo sono i seguenti:</p> <ul style="list-style-type: none"> -Corindone modificato allo zirconio: è dotato di un'elevata tenacità e la proprietà di spezzarsi ad elevate temperature facendo sì che il grano si rigeneri creando nuovi "spigoli" taglienti. Questa tipologia di abrasivo si ottiene mettendo nell'elettrofusione ossido di zirconio. Questo abrasivo è uno dei più efficaci e duraturi in commercio: ha elevatissima tenacità e resistenza alle più gravose sollecitazioni. Inoltre, grazie alla capacità di autorinnovare i propri spigoli taglienti, si ottiene un'altissima velocità di taglio. - Corindone Rosso Bruno: si tratta del più comune degli abrasivi: ha un livello medio di tenacità e friabilità. E' formato da un cristallo di ossido di alluminio contenente una piccola percentuale di ossido di ferro e di ossido di titanio che ne migliorano le caratteristiche della tenacità dello stesso. 	

GUIDA ALLA SCELTA DELLO SPESSORE DEL DISCO DA TAGLIO

Diametro del disco	Spessore	Tipologia di utilizzo
75 - 125 mm	1.0mm	Spessore finalizzato alla rapidità di lavorazione, comfort di utilizzo e qualità del taglio.
	1.3 - 1.6mm	Spessore finalizzato alla durata del disco e al confort di utilizzo.
	≥ 2mm	Utilizzo Gravoso
150 - 230 mm	2mm	Spessore finalizzato alla durata del disco e al confort di utilizzo.
	≥ 3mm	Utilizzo Gravoso

I nostri test sono effettuati utilizzando un elettrotensile da 1200W tagliando un tubo sezione rettangolare 40 x 15 x 1.5 in AISI 304 utilizzando dischi diametro 125 mm e spessore nominale 1.0 mm effettuando tutti i tagli possibili con il disco fino a fine vita dello stesso.

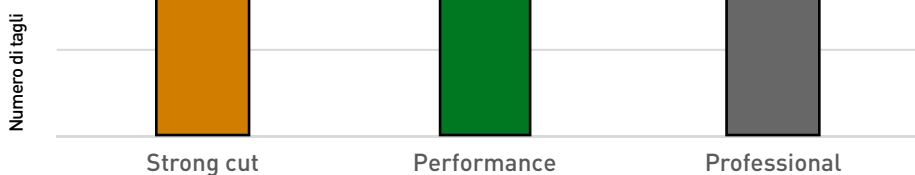

**ZTD8X****DISCO DA TAGLIO PROFESSIONAL ALLO ZIRCONIO**

Dischi a cupola stretta, per massimizzare l'area piana di lavoro. Consente di effettuare più tagli, più profondi rispetto ad un disco a centro depresso e la stessa durata e capacità di taglio di un disco piano con il vantaggio della maggiore rigidità data dalla forma a centro depresso e dalla cupola. Lo spessore estremamente sottile permette l'esecuzione di tagli con minima formazione di bave.

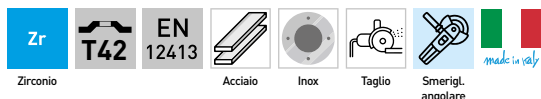

Art.	€	Dimensioni	Specifica	Pack
ZTD8115/1.0	€ 2,31	115 x 1,0 x 22 mm	ZA-60-SXBF	25
ZTD8125/1.0	€ 2,52	125 x 1,0 x 22 mm	ZA-60-SXBF	25

**MTP8X****DISCO DA TAGLIO PROFESSIONAL**

Per usi specifici. Pensato per professionisti che necessitano di un numero elevato di tagli di alta qualità. Vantano una conformazione a coste elicoidali su entrambi i lati, che permette di avere un taglio più veloce e più freddo. La massima evoluzione dei dischi da taglio sottili.



Art.	€	Dimensioni	Specifica	Pack
MTP8115/1.0	€ 1,64	115 x 1,0 x 22 mm	A60S	25
MTP8115/1.3	€ 1,68	115 x 1,3 x 22 mm	A60S	25
MTP8115/1.6	€ 1,74	115 x 1,6 x 22 mm	A60S	25
MTP8125/1.0	€ 1,75	125 x 1,0 x 22 mm	A60S	25
MTP8125/1.3	€ 1,79	125 x 1,3 x 22 mm	A60S	25
MTP8230/2.0	€ 3,66	230 x 2,0 x 22 mm	A60S	25
MTP8125/1.6	€ 1,94	125 x 1,6 x 22 mm	A60S	25

**MTP6X****DISCO DA TAGLIO PERFORMANCE**

Per usi generici. Pensato per artigiani e piccole aziende. Buona qualità del taglio.

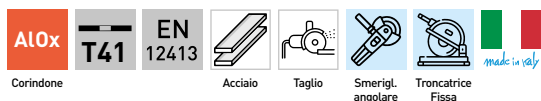

Art.	€	Dimensioni	Specifica	Pack
MTP6075/1.5	€ 1,48	75 x 1,5 x 10 mm	A46-S-BF 80	25
MTP6115/1.0	€ 1,30	115 x 1,0 x 22 mm	A46-R-BF 80	25
MTP6115/1.3	€ 1,30	115 x 1,3 x 22 mm	A46-R-BF 80	25
MTP6115/1.6	€ 1,30	115 x 1,6 x 22 mm	A46-R-BF 80	25
MTP6125/1.0	€ 1,39	125 x 1,0 x 22 mm	A46-S5-BF	25
MTP6125/1.3	€ 1,39	125 x 1,3 x 22 mm	A46-S5-BF	25
MTP6125/1.6	€ 1,39	125 x 1,6 x 22 mm	A46-S5-BF	25
MTP6230/2.0	€ 3,42	230 x 2,0 x 22 mm	A30-R-BF 80	25
MTP6350/3.0	€ 10,30	350 x 3,0 x 25.4 mm	A46-S-BF 80	25



MTD6X

DISCO DA TAGLIO PERFORMANCE

Per usi generici. Pensato per artigiani e piccole aziende. Buona qualità del taglio.



Art.	€	Dimensioni	Specifica	Pack
MTD6115/3.0	€ 1,48	115 x 3,0 x 22 mm	A30-R-BF 80	25
MTD6125/3.2	€ 1,75	125 x 3,2 x 22 mm	A30-S-BF	25
MTD6230/3.0	€ 2,96	230 x 3,0 x 22 mm	A30-R-BF 80	25



MTP4X

DISCO DA TAGLIO STRONG CUT

Per usi generici. Pensato per hobbisti, artigiani e piccole aziende. Ideale sia su acciaio che su inox. Ottimo rapporto qualità/prezzo.

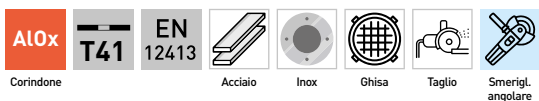

Art.	€	Dimensioni	Specifica	Pack
MTP4075/1.5	€ 0,92	75 x 1,5 x 9,53 mm	A60TBF	100
MTP4115/1.0	€ 0,83	115 x 1,0 x 22 mm	A60TBF	50
MTP4115/1.3	€ 0,83	115 x 1,3 x 22 mm	A60TBF	50
MTP4115/1.6	€ 0,83	115 x 1,6 x 22 mm	A46TBF	50
MTP4125/1.0	€ 0,92	125 x 1,0 x 22 mm	A60TBF	50
MTP4125/1.3	€ 0,92	125 x 1,3 x 22 mm	A60TBF	50
MTP4125/1.6	€ 0,92	125 x 1,6 x 22 mm	A46TBF	50
MTP4230/2.0	€ 2,96	230 x 2,0 x 22 mm	A46TBF	25
MTP4350/3.0	€ 7,90	350 x 3,0 x 22 mm	A30SBF	10



MTD4X

DISCO DA TAGLIO STRONG CUT

Per usi generici. Pensato per hobbisti, artigiani e piccole aziende. Ideale sia su acciaio che su inox. Ottimo rapporto qualità/prezzo.

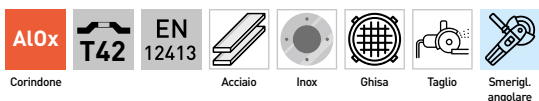

Art.	€	Dimensioni	Specifica	Pack
MTD4115/3.0	€ 1,11	115 x 3,0 x 22 mm	A30SBF	50
MTD4125/3.0	€ 1,39	125 x 3,0 x 22 mm	A30SBF	50
MTD4180/3.0	€ 2,03	180 x 3,0 x 22 mm	A30SBF	25
MTD4230/3.0	€ 2,68	230 x 3,0 x 22 mm	A30SBF	25





MTP9X

DISCO DA TAGLIO INOX

Per usi specifici. Pensato per professionisti dell'inox che necessitano di un numero elevato di tagli di alta qualità. Vantano una conformazione a coste elicoidali su entrambi i lati che permette di avere un taglio più veloce e più freddo.

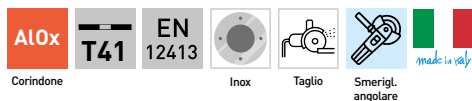

Art.	€	Dimensioni	Specifica	Pack
MTP9115/1.0	€ 1,77	115 x 1,0 x 22 mm	A60SX	25
MTP9115/1.3	€ 1,88	115 x 1,3 x 22 mm	A60SX	25
MTP9115/1.6	€ 1,96	115 x 1,6 x 22 mm	A60SX	25
MTP9125/1.0	€ 1,94	125 x 1,0 x 22 mm	A60SX	25
MTP9125/1.3	€ 2,11	125 x 1,3 x 22 mm	A60SX	25
MTP9125/1.6	€ 2,16	125 x 1,6 x 22 mm	A60SX	25
MTP9230/2.0	€ 4,52	230 x 2,0 x 22 mm	A60SX	25



MTP7X

DISCO DA TAGLIO PER ALLUMINIO

Per usi specifici. Pensato per professionisti dell'alluminio e serramentisti. Ideale su cassonati in alluminio, in fonderie di leghe leggere e si necessita di un numero elevato di tagli di alta qualità. Vanta una conformazione a coste elicoidali su entrambi i lati che permette di avere un taglio più veloce e più freddo, con basso intasamento.



Art.	€	Dimensioni	Specifica	Pack
MTP7115/1.3	€ 1,81	115 x 1,3 x 22 mm	A-60-QAL	25
MTP7125/1.3	€ 2,22	125 x 1,3 x 22 mm	A-60-QAL	25



MTD7X

DISCO DA TAGLIO PER ALLUMINIO

Per usi specifici. Pensato per professionisti dell'alluminio e serramentisti. Ideale su cassonati in alluminio, in fonderie di leghe leggere e si necessita di un numero elevato di tagli di alta qualità. Lunga durata e prestazioni costanti grazie all'aggiunta di additivi specifici anti intasanti



Art.	€	Dimensioni	Specifica	Pack
MTD7230/3.2	€ 4,99	230 x 3,2 x 22 mm	A-30-36-QAL	25



ZSD8X

DISCO DA SBAVO PROFESSIONAL ALLO ZIRCONIO

Per usi specifici e gravosi. Pensato per un uso professionale. Ideale per asportazioni veloci di cordoni di saldatura, cianfrinatura, asportazione di calamina e tubi (vedi oil & gas). Trova applicazione su ghisa, acciaio inox materiali forgiati.

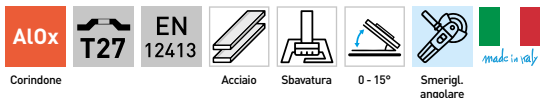

Art.	€	Dimensioni	Specifica	Pack
ZSD8115/7.0	€ 4,16	115 x 7,0 x 22 mm	ZA-60-SXBF	25
ZSD8125/7.0	€ 4,80	125 x 7,0 x 22 mm	ZA-60-SXBF	25
ZSD8230/7.0	€ 13,20	230 x 7,0 x 22 mm	ZA-60-SXBF	25



MSD8X

DISCO DA SBAVO PROFESSIONAL

Per usi specifici. Pensato per professionisti che necessitano di alta capacità di asportazione e resistenza alla fatica. Ideale su lamiere con calamina, per l'asportazione di cordoni importanti e bave da ossitaglio.

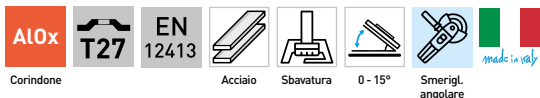

Art.	€	Dimensioni	Specifica	Pack
MSD8115/6.5	€ 2,49	115 x 6,5 x 22 mm	A-Q	25
MSD8125/6.5	€ 2,74	125 x 6,5 x 22 mm	A-Q	25
MSD8230/7.0	€ 6,70	230 x 7,0 x 22 mm	A-Q	25



MSD6X

DISCO DA SBAVO PERFORMANCE

Per usi generici. Pensato per artigiani e piccole aziende. Con una buona qualità su cordoni di saldatura, lamiere con calamina e sbavatura in genere.

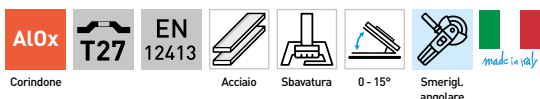

Art.	€	Dimensioni	Specifica	Pack
MSD6115/6.0	€ 2,03	115 x 6,0 x 22 mm	A24-R-BF 80	25
MSD6125/6.5	€ 2,41	125 x 6,5 x 22 mm	A30-S-BF	25
MSD6230/6.0	€ 5,70	230 x 6,0 x 22 mm	A24-R-BF 80	25





MSD4X

DISCO DA SBAVO STRONG CUT

Per usi generici. Pensato per hobbisti, artigiani e piccole aziende. Ideale sia su acciaio che su inox. Ottimo rapporto qualità/prezzo.

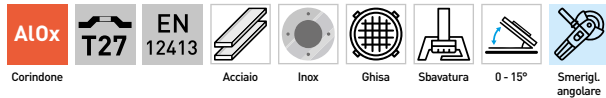

Art.	€	Dimensioni	Specifica	Pack
MSD4115/6.0	€ 1,57	115 x 6.0 x 22 mm	A24RBF	25
MSD4125/6.0	€ 1,94	125 x 6.0 x 22 mm	A24RBF	25
MSD4180/6.0	€ 3,97	180 x 6.0 x 22 mm	A24RBF	20
MSD4230/6.0	€ 5,10	230 x 6.0 x 22 mm	A24RBF	15



MSD7X

DISCO DA SBAVO PER ALLUMINIO

Per usi specifici. Pensato per professionisti dell'alluminio e serramentisti. Ideale su cassonati in alluminio, in fonderie di leghe leggere e si necessita di una grande capacità di asportazione. Lunga durata e prestazioni costanti grazie all'aggiunta di additivi specifici anti intasanti



Art.	€	Dimensioni	Specifica	Pack
MSD7230/7.0	€ 9,20	230 x 7,0 x 22 mm	A-24-30-36-QAL	25



M16X

MOLE ABRASIVE

Corindone rosa



AIOx

Corindone

Art.	€	Dimensioni	Specifiche
M159	€ 7,70	Ø 100 x 4,5 x 10 mm	GR80
M160	€ 7,70	Ø 100 x 3,2 x 10 mm	GR80
M163	€ 14,10	Ø 145 x 3,2 x 22,3 mm	GR 80
M162	€ 14,10	Ø 145 x 4,7 x 22,3 mm	GR80

MGX

MOLE ABRASIVA IN CORINDONE GRIGIO

Per sgrassatura acciai, dotata di riduttori concentrici per adattarsi a tutte le macchine fisse.



AIOx

Corindone



Art.	€	Dimensioni	Grana	Velocità max di utilizzo		Adattatori
MG01/36	€ 7,30	150 x 20 x 32 mm	36	4500 rpm	35 m/s	12,7 - 16 - 20 - 25 mm
MG01/46	€ 7,30	150 x 20 x 32 mm	46	4500 rpm	35 m/s	12,7 - 16 - 20 - 25 mm
MG01/60	€ 7,30	150 x 20 x 32 mm	60	4500 rpm	35 m/s	12,7 - 16 - 20 - 25 mm
MG01/80	€ 7,30	150 x 20 x 32 mm	80	4500 rpm	35 m/s	12,7 - 16 - 20 - 25 mm
MG02/36	€ 7,80	200 x 20 x 32 mm	36	3350 rpm	35 m/s	12,7 - 16 - 20 - 25 mm
MG02/46	€ 7,80	200 x 20 x 32 mm	46	3350 rpm	35 m/s	12,7 - 16 - 20 - 25 mm
MG02/60	€ 7,80	200 x 20 x 32 mm	60	3350 rpm	35 m/s	12,7 - 16 - 20 - 25 mm
MG02/80	€ 7,80	200 x 20 x 32 mm	80	3350 rpm	35 m/s	12,7 - 16 - 20 - 25 mm
MG03/36	€ 10,30	200 x 25 x 32 mm	36	3350 rpm	35 m/s	12,7 - 16 - 20 - 25 mm
MG03/46	€ 10,30	200 x 25 x 32 mm	46	3350 rpm	35 m/s	12,7 - 16 - 20 - 25 mm
MG03/60	€ 10,30	200 x 25 x 32 mm	60	3350 rpm	35 m/s	12,7 - 16 - 20 - 25 mm
MG03/80	€ 10,30	200 x 25 x 32 mm	80	3350 rpm	35 m/s	12,7 - 16 - 20 - 25 mm
MG04/36	€ 15,60	250 x 25 x 32 mm	36	3350 rpm	35 m/s	12,7 - 16 - 20 - 25 mm
MG04/46	€ 15,60	250 x 25 x 32 mm	46	2650 rpm	35 m/s	12,7 - 16 - 20 - 25 mm
MG04/60	€ 15,60	250 x 25 x 32 mm	60	2650 rpm	35 m/s	12,7 - 16 - 20 - 25 mm
MG04/80	€ 15,60	250 x 25 x 32 mm	80	2650 rpm	35 m/s	12,7 - 16 - 20 - 25 mm
MG06/80	€ 19,30	200 x 40 x 20 mm	80	3350 rpm	35 m/s	- mm

MVX

MOLE ABRASIVA IN CARBURO DI SILICIO

Per la sbavatura metalli non ferrosi, dotata di riduttori concentrici per adattarsi a tutte le macchine fisse.



SiC

Carburo di Silicio



Alluminio



HM



Smerigl. Fissa

Art.	€	Dimensioni	Grana	Velocità max di utilizzo		Adattatori
MV01/80	€ 12,20	150 x 20 x 32 mm	80	4500 rpm	35 m/s	12,7 - 16 - 20 - 25 mm
MV02/80	€ 14,50	200 x 20 x 32 mm	80	3350 rpm	35 m/s	12,7 - 16 - 20 - 25 mm
MV03/80	€ 17,70	200 x 25 x 32 mm	80	3350 rpm	35 m/s	12,7 - 16 - 20 - 25 mm
MV04/80	€ 27,90	250 x 25 x 32 mm	80	2650 rpm	35 m/s	12,7 - 16 - 20 - 25 mm

MBX

MOLE ABRASIVA IN CORINDONE BIANCO

Per finitura acciai, dotata di riduttori concentrici per adattarsi a tutte le macchine fisse.



AIOx

Corindone



HSS



Sbavatura



Smerigl. Fissa

Art.	€	Dimensioni	Grana	Velocità max di utilizzo		Adattatori
MB01/60	€ 7,70	150 x 20 x 32 mm	60	4500 rpm	35 m/s	12,7 - 16 - 20 - 25 mm
MB02/60	€ 8,10	200 x 20 x 32 mm	60	3350 rpm	35 m/s	12,7 - 16 - 20 - 25 mm
MB03/60	€ 10,90	200 x 25 x 32 mm	60	3350 rpm	35 m/s	12,7 - 16 - 20 - 25 mm
MB04/60	€ 22,30	250 x 25 x 32 mm	60	2650 rpm	35 m/s	12,7 - 16 - 20 - 25 mm

**MCGXA****MOLE VETRIFICATE ROSA**

Forma cilindrica "A" impiegate per sgrossare, smerigliare e finire piccole superfici di difficile accesso. Le molette vetrificate sono indicate per acciai teneri, bassolegati, ghisa.

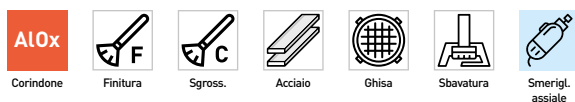

Art.	€	Misura	Gambo	Max rpm	Pack
MCG0306/03A	€ 0,53	Ø 3 x 6 mm	3 mm	50000	25
MCG0408/03A	€ 0,53	Ø 4 x 8 mm	3 mm	50000	25
MCG0510/03A	€ 0,53	Ø 5 x 10 mm	3 mm	50000	25
MCG0610/03A	€ 0,53	Ø 6 x 10 mm	3 mm	47750	25
MCG0610/06A	€ 0,53	Ø 6 x 10 mm	6 mm	47750	25
MCG0810/03A	€ 0,53	Ø 8 x 10 mm	3 mm	38590	25
MCG0810/06A	€ 0,53	Ø 8 x 10 mm	6 mm	38590	25
MCG1010/03A	€ 0,63	Ø 10 x 10 mm	3 mm	28640	25
MCG1010/06A	€ 0,83	Ø 10 x 10 mm	6 mm	28640	25
MCG1020/06A	€ 0,87	Ø 10 x 20 mm	6 mm	28640	25



Art.	€	Misura	Gambo	Max rpm	Pack
MCG1520/06A	€ 0,93	Ø 15 x 20 mm	6 mm	19000	25
MCG1530/06A	€ 1,19	Ø 15 x 30 mm	6 mm	19000	25
MCG2020/06A	€ 1,19	Ø 20 x 20 mm	6 mm	14320	25
MCG2025/06A	€ 1,39	Ø 20 x 25 mm	6 mm	14320	25
MCG2030/06A	€ 1,50	Ø 20 x 30 mm	6 mm	14320	25
MCG2525/06A	€ 1,39	Ø 25 x 25 mm	6 mm	11460	25
MCG3030/06A	€ 1,93	Ø 30 x 30 mm	6 mm	9540	25
MCG4020/06A	€ 2,51	Ø 40 x 20 mm	6 mm	7150	25
MCG4040/06A	€ 3,62	Ø 40 x 40 mm	6 mm	7150	25
MCG5010/06A	€ 2,51	Ø 50 x 10 mm	6 mm	5750	25

MCGXC**MOLE VETRIFICATE ROSA**

Forma conica "C" impiegate per sgrossare, smerigliare e finire piccole superfici di difficile accesso. Le molette vetrificate sono indicate per acciai teneri, bassolegati, ghisa.



Art.	€	Misura	Gambo	Max rpm	Pack
MCG1020/06C	€ 1,00	10 x 20 mm	6 mm	28640	25
MCG1520/06C	€ 1,09	15 x 20 mm	6 mm	19000	25
MCG1540/06C	€ 1,81	15 x 40 mm	6 mm	19000	25
MCG2030/06C	€ 1,50	20 x 30 mm	6 mm	14320	25
MCG2540/06C	€ 2,70	25 x 40 mm	6 mm	11460	25
MCG3040/06C	€ 2,44	30 x 40 mm	6 mm	9540	25

**MCGXS****MOLE VETRIFICATE ROSA**

Forma sferica "S" impiegate per sgrossare, smerigliare e finire piccole superfici di difficile accesso. Le molette vetrificate sono indicate per acciai teneri, bassolegati, ghisa.



Art.	€	Misura	Gambo	Max rpm	Pack
MCG10/06S	€ 1,09	Ø 10 mm	6 mm	28640	25
MCG15/06S	€ 0,98	Ø 15 mm	6 mm	19000	25
MCG20/06S	€ 1,36	Ø 20 mm	6 mm	14320	25
MCG25/06S	€ 1,97	Ø 25 mm	6 mm	11640	25
MCG30/06S	€ 2,13	Ø 30 mm	6 mm	9540	25

**MCG2050/06G****€ 2,41****MOLE VETRIFICATE ROSA**

Forma ogiva "G" impiegate per sgrossare, smerigliare e finire piccole superfici di difficile accesso. Le molette vetrificate sono indicate per acciai teneri, bassolegati, ghisa.



Misura	Ø 20 x 50 mm
Gambo	6 mm
Max rpm	14320
Pack	25

**MBGXA****MOLE RESINOIDI IN BAKELITE**

Forma conica "C" impiegate per sgrossare, smerigliare e finire piccole superfici di difficile accesso. Le molette in bakelite sono indicate per acciai teneri, bassolegati, ghisa.



Art.	€	Misura	Gambo
MBG1030/06A	€ 1,50	Ø 10 x 30 mm	6 mm
MBG1530/06A	€ 1,64	Ø 15 x 30 mm	6 mm
MBG2020/06A	€ 1,47	Ø 20 x 20 mm	6 mm
MBG2030/06A	€ 1,69	Ø 20 x 30 mm	6 mm
MBG2040/06A	€ 2,15	Ø 20 x 40 mm	6 mm
MBG2525/06A	€ 1,69	Ø 25 x 25 mm	6 mm
MBG2535/06A	€ 2,02	Ø 25 x 35 mm	6 mm
MBG3010/06A	€ 1,39	Ø 30 x 10 mm	6 mm
MBG3030/06A	€ 1,95	Ø 30 x 30 mm	6 mm
MBG4020/06A	€ 2,47	Ø 40 x 20 mm	6 mm
MBG4035/06A	€ 3,22	Ø 40 x 35 mm	6 mm
MBG5010/06A	€ 2,47	Ø 50 x 10 mm	6 mm



MBGXC

MOLE RESINOIDI IN BAKELITE

Forma conica "C" impiegate per sgrassare, smerigliare e finire piccole superfici di difficile accesso. Le molette in bakelite sono indicate per acciai teneri, bassolegati, ghisa.



Art.	€	Misura	Gambo
MBG1540/06C	€ 2,56	Ø 15 x 40 mm	6 mm
MBG2040/06C	€ 2,76	Ø 20 x 40 mm	6 mm
MBG2535/06C	€ 2,56	Ø 25 x 35 mm	6 mm

0163

€ 8,30

SET MOLE ABRASIVE



10 Pcs

Gambo

Ø 3 - 6 mm

0816

€ 6,40

PIETRA PER AFFILARE IN CARBURO DI SILICIO GRANA MEDIA E GRANA FINE



SiC

Carburo di Silicio

Dimensioni

200 x 50 x 25h mm

0817

€ 6,10

PIETRA PER AFFILARE IN OSSIDO DI ALLUMINIO GRANA MEDIA E GRANA FINE



AlOx

Corindone

Dimensioni

200 x 50 x 25h mm

D100

€ 46,20

DIAMANTE PER RAVVIVARE MOLE

Tipo naturale

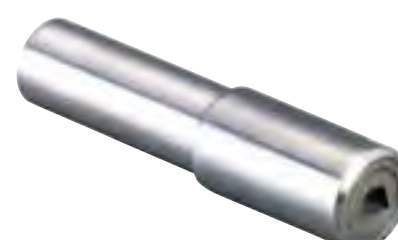

Diamante

Gambo	Ø 10 mm
Lunghezza	48 mm
Carati	1

D100/S

€ 31,90

DIAMANTE PER RAVVIVARE MOLE

Tipo sintetico



Diamante

Gambo	Ø 10 mm
Lunghezza	48 mm
Carati	1

**D045-****DISCHI DIAMANTATI CORONA CONTINUA**

Uso generale, per il taglio di marmo, piastrelle e ceramica con acqua.



Art.	€	Diametro	Foro	Altezza diamante	Spessore taglio	Max rpm
D045/115	€ 5,00	Ø 115 mm	Ø 22,2 mm	5 mm	2.0	13300
D045/180	€ 14,60	Ø 180 mm	Ø 22,2 mm	5 mm	2.4	8500
D045/230	€ 20,60	Ø 230 mm	Ø 22,2 mm	5 mm	2.8	6600

**D070-****DISCHI DIAMANTATI PER GRES PORCELLANATO PROFESSIONALI**

Speciali per il taglio di gres porcellanato, klinker, travertino, cotto, ceramica dura, piastrelle, marmo con acqua e senz'acqua



Art.	€	Diametro	Foro	Altezza diamante	Spessore taglio	Max rpm
D070/115	€ 27,30	Ø 115 mm	Ø 22,2 mm	10 mm	1.3 mm	13300
D070/180	€ 56,40	Ø 180 mm	Ø 22,2 mm	10 mm	1.6 mm	8500
D070/230	€ 79,80	Ø 230 mm	Ø 22,2 mm	10 mm	2.0 mm	6600

**PRO****D060-****DISCHI DIAMANTATI VENTILATI PROFESSIONALI**

Long life, per il taglio di muro, cemento, piastrelle, pietra, marmo con e senz'acqua



Art.	€	Diametro	Foro	Altezza diamante	Spessore taglio	Max rpm
D060/115	€ 13,90	Ø 115 mm	Ø 22,2 mm	10 mm	1.4 mm	13300
D060/180	€ 49,30	Ø 180 mm	Ø 22,2 mm	10 mm	1.8 mm	8500
D060/230	€ 68,90	Ø 230 mm	Ø 22,2 mm	10 mm	2.4 mm	6600

**PRO****D059-****DISCHI DIAMANTATI VENTILATI**

Uso generale, per il taglio di muro, cemento, piastrelle, pietra, marmo con acqua e senz'acqua



Art.	€	Diametro	Foro	Altezza diamante	Spessore taglio	Max rpm
D059/115	€ 8,10	Ø 115 mm	Ø 22,2 mm	7 mm	2.0 mm	13300
D059/180	€ 20,60	Ø 180 mm	Ø 22,2 mm	7 mm	2.4 mm	8500
D059/230	€ 38,30	Ø 230 mm	Ø 22,2 mm	7 mm	2.8 mm	6600



D055-

PRO

DISCHI DIAMANTATI VENTILATI A SEGMENTI PROFESSIONALI

Long life, per il taglio di muro, cemento, pietra, marmo senz'acqua



Art.	€	Diametro	Foro	Altezza diamante	Segmenti	Spessore taglio	Max rpm
D055/115	€ 15,50	Ø 115 mm	Ø 22,2 mm	10 mm	9	1.9 mm	13300
D055/180	€ 45,10	Ø 180 mm	Ø 22,2 mm	10 mm	14	2.2 mm	8500
D055/230	€ 68,90	Ø 230 mm	Ø 22,2 mm	10 mm	18	2.6 mm	6600



D054-

DISCHI DIAMANTATI VENTILATI A SEGMENTI

Uso generale, per il taglio di muro, cemento, pietra, marmo senz'acqua



Art.	€	Diametro	Foro	Altezza diamante	Segmenti	Spessore taglio	Max rpm
D054/115	€ 6,30	Ø 115 mm	Ø 22,2 mm	7 mm	9	2.0	13300
D054/180	€ 17,90	Ø 180 mm	Ø 22,2 mm	7 mm	14	2.4	8500
D054/230	€ 26,50	Ø 230 mm	Ø 22,2 mm	7 mm	18	2.8	6600



0350

€ 46,80

DISCO DIAMANTATO TURBO VENTILATO



Dimensioni	Ø 230 mm
Foro	Ø 22,2 mm
Secco - Acqua	



0709

€ 12,80

DISCO DIAMANTATO TURBO VENTILATO

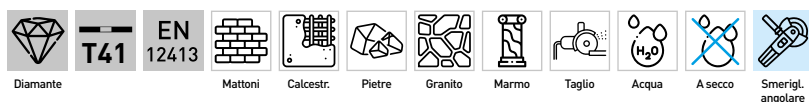

Dimensioni	Ø 115 mm
Foro	Ø 22,2 mm
Secco - Acqua	





0833

€ 62,80

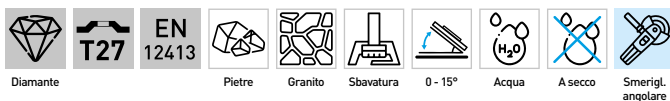
PLATORELLO DIAMANTATO TURBO A TAZZA PER GRANITO E PIETRE

Dimensioni	Ø 100 mm
Foro	Ø 22,2 mm
Secco - Acqua	



D040-

PLATORELLO DIAMANTATO A SEGMENTI







Uso generale, per gres porcellanato, klinker, travertino, cotto, ceramica dura, piastrelle, marmo con acqua e senz'acqua







Art.	€	Diametro	Foro	Segmenti	Max rpm
D040/115	€ 26,80	Ø 115 mm	Ø 22,2 mm	8 + 8	13300
D040/180	€ 53,80	Ø 180 mm	Ø 22,2 mm	14 + 14	8500









	 ARREDAMENTO DA OFFICINA
p. 310	 — Arredamenti modulari
p. 319	 — Banchi da lavoro
p. 320	 — Armadietti e contenitori
p. 325	 — Carrelli portautensili
p. 328	 — Cassette e valigette

	 MORSE DA BANCO E INCUDINI
p. 333	 — Morse da banco
p. 335	 — Morsetti
p. 337	 — Incudini

	 MACCHINE PER TRATTAMENTI E FINITURE
p. 338	 — Sabbiatrici
p. 347	 — Lavapezzi
p. 349	 — Aspirapolvere aspiraliquidi
p. 352	 — Marcatura

	 PRESSE E DIVARICATORI
p. 355	 — Presse idrauliche
p. 358	 — Presse manuali
p. 359	 — Pompe idrauliche

	 OFFICINA AUTO E MOTO
p. 360	 — Cric a carrello e cavalletti
p. 362	 — Gruette e supporti motore
p. 364	 — Unità raccogli olio
p. 365	 — Argani per auto
p. 366	 — Caricabatterie
p. 367	 — Sollevatori da moto e quad
p. 369	 — Carrellini sottauto

	 SOLLEVAMENTO E MOVIMENTAZIONE
p. 370	 — Cric idraulici
p. 371	 — Carrelli
p. 373	 — Paranchi
p. 374	 — Accessori per il sollevamento
p. 377	 — Argani e tendi cavi
p. 378	 — Movimentazione pallet



LA SOLUZIONE OTTIMALE PER ARREDARE LA TUA OFFICINA, IL TUO GARAGE O IL TUO ANGOLO RACING

SCEGLI TRA LE COMPOSIZIONI CREATE PER TE DA FERVI O CONFIGURA IL TUO ARREAMENTO DA OFFICINA MODULARE ED AUTOPORTANTE SECONDO LE TUE ESIGENZE.

A007/07

PROFILO DI GIUNZIONE PER PANNELLI FORATI
NECESSARI PER COLLEGARE I MODULI

A007/02

ARMADIO ALTO
CON 3 PIANI INTERNI

A007/10

PANNELLO FORATO

A007/01

ARMADIO PENSILE
DA FISSARE AL PANNELLO FORATO

A007/11

TERMINALE PER PANNELLI FORATI
PER TERMINARE LA CONFIGURAZIONE SENZA ARMADIO

A007/09

PIANI DI LAVORO
DISPONIBILI IN 3 MISURE E 2 MATERIALI

A007/03

ARMADIO BASSO A DUE ANTE
CON UN PIANO INTERNO

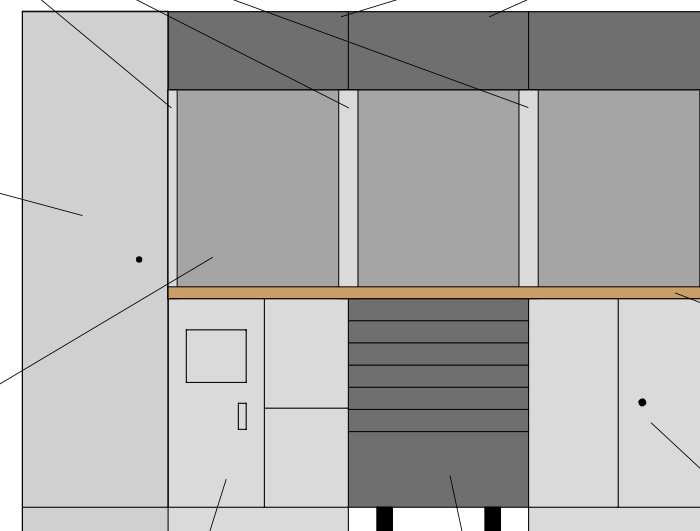

A007/06

ARMADIO BASSO MULTIFUNZIONE

A007/16

CASSETTIERA A CARRELLO
DEVE ESSERE INSERITA NELLO SPAZIO CENTRALE DI UN PIANO A 3 MODULI

ESEMPIO DI CONFIGURAZIONE A TRE MODULI CON ARMADIO

**A007A**

€ 4480,00

ARREDAMENTO MODULARE PER OFFICINA

La soluzione ottimale per arredare la tua officina, il tuo garage o il tuo angolo racing

- 4 ARMADI PENSILI CON AMMORTIZZATORI A GAS [A007/01]
- 2 ARMADI ALTI CON 3 PIANI INTERNI [A007/02]
- 1 ARMADIO BASSO A DUE ANTE CON UN PIANO INTERNO [A007/03]
- 1 CASSETTIERA A 4 CASSETTI SU CUSCINETTI [A007/04]
- 2 CASSETTIERE A 5 CASSETTI SU CUSCINETTI [A007/05]
- 5 PROFILI DI GIUNZIONE PER PANNELLI FORATI [A007/07]
- 2 PIANI IN LEGNO [A007/08]
- 4 PANNELLI FORATI [A007/10]

Dimensioni 3920 x 498 x 2000h mm

**A008A** € 4710,00

CON PIANO IN ACCIAIO INOX

A007B

€ 4390,00

ARREDAMENTO MODULARE PER OFFICINA

La soluzione ottimale per arredare la tua officina, il tuo garage o il tuo angolo racing

- 4 ARMADI PENSILI CON AMMORTIZZATORI A GAS [A007/01]
- 2 ARMADI ALTI CON 3 PIANI INTERNI [A007/02]
- 1 ARMADIO BASSO A DUE ANTE CON UN PIANO INTERNO [A007/03]
- 2 CASSETTIERE A 5 CASSETTI SU CUSCINETTI [A007/05]
- 1 ARMADIO BASSO MULTIFUNZIONE [A007/06]
- 5 PROFILI DI GIUNZIONE PER PANNELLI FORATI [A007/07]
- 2 PIANI IN LEGNO [A007/08]
- 4 PANNELLI FORATI [A007/10]

Dimensioni 3920 x 498 x 2000h mm

**A008B** € 4590,00

CON PIANO IN ACCIAIO INOX

A007C

€ 2160,00

ARREDAMENTO MODULARE PER OFFICINA

La soluzione ottimale per arredare la tua officina, il tuo garage o il tuo angolo racing

- 2 ARMADI PENSILI CON AMMORTIZZATORI A GAS [A007/01]
- 1 ARMADI ALTI CON 3 PIANI INTERNI [A007/02]
- 1 ARMADIO BASSO A DUE ANTE CON UN PIANO INTERNO [A007/03]
- 1 CASSETTIERA A 5 CASSETTI SU CUSCINETTI [A007/05]
- 2 PROFILI DI GIUNZIONE PER PANNELLI FORATI [A007/07]
- 1 PIANO IN LEGNO [A007/08]
- 2 PANNELLI FORATI [A007/10]
- 1 PROFILO PER PANNELLI FORATI [A007/11]

Dimensioni 1960 x 498 x 2000h mm

**A008C** € 2270,00

CON PIANO IN ACCIAIO INOX

A007D

€ 3010,00

ARREDAMENTO MODULARE PER OFFICINA

La soluzione ottimale per arredare la tua officina, il tuo garage o il tuo angolo racing

- 3 ARMADI PENSILI CON AMMORTIZZATORI A GAS [A007/01]
- 1 ARMADIO ALTO CON 3 PIANI INTERNI [A007/02]
- 1 ARMADIO BASSO A DUE ANTE CON UN PIANO INTERNO [A007/03]
- 1 CASSETTIERA A 4 CASSETTI SU CUSCINETTI [A007/04]
- 1 CASSETTIERE A 5 CASSETTI SU CUSCINETTI [A007/05]
- 3 PROFILI DI GIUNZIONE PER PANNELLI FORATI [A007/07]
- 1 PIANO IN LEGNO [A007/09]
- 3 PANNELLI FORATI [A007/10]
- 1 PROFILO PER PANNELLO FORATO [A007/11]

Dimensioni 2640 x 498 x 2000h mm

**A008D** € 3150,00

CON PIANO IN ACCIAIO INOX

A007E

€ 2480,00

ARREDAMENTO MODULARE PER OFFICINA

La soluzione ottimale per arredare la tua officina, il tuo garage o il tuo angolo racing

- 3 ARMADI PENSILI CON AMMORTIZZATORI [A007/01]
- 1 ARMADIO ALTO CON 3 PIANI INTERNI [A007/02]
- 1 ARMADIO BASSO A DUE ANTE CON PIANO INTERNO [A007/03]
- 1 ARMADIO BASSO MULTIFUNZIONE [A007/06]
- 3 PROFILI DI GIUNZIONE PER PANNELLI FORATI [A007/07]
- 1 PIANO IN LEGNO [A007/09]
- 3 PANNELLI FORATI [A007/10]
- 1 CASSETTIERA A CARRELLO CON 7 CASSETTI SU CUSCINETTI [A007/16]

Dimensioni 2640 x 498 x 2000h mm



A008E

€ 2580,00

CON PIANO IN ACCIAIO INOX

A007F

€ 1160,00

ANGOLO PER ARREDAMENTO MODULARE DA OFFICINA

La soluzione ottimale per arredare la tua officina, il tuo garage o il tuo angolo racing

- 2 PROFILI DI GIUNZIONE PER PANNELLI FORATI [A007/07]
- 2 PROFILI PER PANNELLO FORATO [A007/11]
- 2 PANNELLI FORATI PER ANGOLO [A007/12]
- 1 ARMADIO PENSILE PER ANGOLO CON AMMORTIZZATORI A GAS [A007/13]
- 1 PIANO IN LEGNO PER ANGOLO [A007/14]
- 1 ARMADIO BASSO ANGOLARE CON UN PIANO INTERNO [A007/15]

Dimensioni 864 x 864 x 2000h mm



A008F

€ 1220,00

CON PIANO IN ACCIAIO INOX

A007G

€ 2560,00

ARREDAMENTO MODULARE PER OFFICINA

La soluzione ottimale per arredare la tua officina, il tuo garage o il tuo angolo racing

- 3 ARMADI PENSILI CON AMMORTIZZATORI [A007/01]
- 1 ARMADIO ALTO CON 3 PIANI INTERNI [A007/02]
- 1 ARMADIO BASSO A DUE ANTE CON UN PIANO INTERNO [A007/03]
- 1 ARMADIO BASSO MULTIFUNZIONE [A007/06]
- 3 PROFILI DI GIUNZIONE PER PANNELLI FORATI [A007/07]
- 1 PIANO IN LEGNO [A007/09]
- 3 PANNELLI FORATI [A007/10]
- 1 PROFILO PER PANNELLI FORATI [A007/11]
- 1 CASSETTIERA CON 7 CASSETTI SU CUSCINETTI [A007/17]

Dimensioni 2640 x 498 x 2000h mm



A008G

€ 2700,00

CON PIANO IN ACCIAIO INOX

A007H

€ 4850,00

ARREDAMENTO MODULARE PER OFFICINA

La soluzione ottimale per arredare la tua officina, il tuo garage o il tuo angolo racing

- 5 ARMADI PENSILI CON AMMORTIZZATORI [A007/01]
- 1 ARMADIO ALTO CON 3 PIANI INTERNI [A007/02]
- 1 ARMADIO BASSO A DUE ANTE CON UN PIANO INTERNO [A007/03]
- 1 CASSETTIERA A 4 CASSETTI SU CUSCINETTI [A007/04]
- 1 CASSETTIERA A 5 CASSETTI SU CUSCINETTI [A007/05]
- 1 ARMADIO BASSO MULTIFUNZIONE [A007/06]
- 6 PROFILI DI GIUNZIONE PER PANNELLI FORATI [A007/07]
- 1 PIANO IN LEGNO [A007/08]
- 1 PIANO IN LEGNO [A007/09]
- 5 PANNELLI FORATI [A007/10]
- 3 PROFILI PER PANNELLI FORATI [A007/11]
- 2 PANNELLI FORATI PER ANGOLARE [A007/12]
- 1 ARMADIO ANGOLARE PENSILE CON AMMORTIZZATORI [A007/13]
- 1 PIANO IN LEGNO ANGOLARE [A007/14]
- 1 ARMADIO BASSO ANGOLARE CON UN PIANO INTERNO [A007/15]
- 1 CASSETTIERA A CARRELLO CON 7 CASSETTI SU CUSCINETTI [A007/16]



Dimensioni 3500 x 2250 x 2000h mm
Profondità 498 mm

A008H

€ 5100,00

CON PIANO IN ACCIAIO INOX

**A007I**

€ 2320,00

ARREDAMENTO MODULARE PER OFFICINA

La soluzione ottimale per arredare la tua officina, il tuo garage o il tuo angolo racing

- 2 ARMADI PENSILI CON AMMORTIZZATORI A GAS [A007/01]
- 1 ARMADIO ALTO CON 3 PIANI INTERNI [A007/02]
- 1 ARMADIO BASSO MULTIFUNZIONE [A007/06]
- 2 PROFILI DI GIUNZIONE PER PANNELLI FORATI [A007/07]
- 1 PIANO IN LEGNO [A007/08]
- 2 PANNELLI FORATI [A007/10]
- 1 PROFILO PER PANNELLI FORATI [A007/11]
- 1 CASSETTIERA A 7 CASSETTI SU CUSCINETTI [A007/17]

Dimensioni 1960 x 498 x 2000h mm

**A008I** € 2430,00

CON PIANO IN ACCIAIO INOX

A007L

€ 5110,00

ARREDAMENTO MODULARE PER OFFICINA

La soluzione ottimale per arredare la tua officina, il tuo garage o il tuo angolo racing

- 4 ARMADI PENSILI CON AMMORTIZZATORI A GAS [A007/01]
- 2 ARMADIO ALTO CON 3 PIANI INTERNI [A007/02]
- 1 ARMADIO BASSO A DUE ANTE CON UN PIANO INTERNO [A007/03]
- 1 CASSETTIERA A 4 CASSETTI SU CUSCINETTI [A007/04]
- 1 ARMADIO BASSO MULTIFUNZIONE [A007/06]
- 6 PROFILI DI GIUNZIONE PER PANNELLI FORATI [A007/07]
- 2 PIANI IN LEGNO [A007/08]
- 4 PANNELLI FORATI [A007/10]
- 2 PROFILI PER PANNELLI FORATI [A007/11]
- 2 PANNELLI FORATI PER ANGOLARE [A007/12]
- 1 ARMADIO ANGOLARE PENSILE CON AMMORTIZZATORI A GAS [A007/13]
- 1 PIANO IN LEGNO ANGOLARE [A007/14]
- 1 ARMADIO BASSO ANGOLARE CON UN PIANO INTERNO [A007/15]
- 1 CASSETTIERA A 7 CASSETTI SU CUSCINETTI [A007/17]



Dimensioni 2800 x 2800 x 2000h mm
Profondità 498 mm

A008L € 5380,00

CON PIANO IN ACCIAIO INOX

A007M

€ 1560,00

ARREDAMENTO MODULARE PER OFFICINA

La soluzione ottimale per arredare la tua officina, il tuo garage o il tuo angolo racing

- 2 ARMADI PENSILI CON AMMORTIZZATORI A GAS [A007/01]
- 1 ARMADIO BASSO A DUE ANTE CON UN PIANO INTERNO [A007/03]
- 1 CASSETTIERA A 5 CASSETTI SU CUSCINETTI [A007/05]
- 2 PROFILI DI GIUNZIONE PER PANNELLI FORATI [A007/07]
- 1 PIANO IN LEGNO [A007/08]
- 2 PANNELLI FORATI [A007/10]
- 2 PROFILI PER PANNELLI FORATI [A007/11]

Dimensioni 1360 x 498 x 2000h mm

**A008M** € 1650,00

CON PIANO IN ACCIAIO INOX

A007N

€ 2510,00

ARREDAMENTO MODULARE PER OFFICINA

La soluzione ottimale per arredare la tua officina, il tuo garage o il tuo angolo racing

- 3 ARMADI PENSILI CON AMMORTIZZATORI A GAS [A007/01]
- 1 ARMADIO BASSO A DUE ANTE CON UN PIANO INTERNO [A007/03]
- 1 CASSETTIERA A 4 CASSETTI SU CUSCINETTI [A007/04]
- 1 CASSETTIERA A 5 CASSETTI SU CUSCINETTI [A007/05]
- 3 PROFILI DI GIUNZIONE PER PANNELLI FORATI [A007/07]
- 1 PIANO IN LEGNO [A007/09]
- 3 PANNELLI FORATI [A007/10]
- 2 PROFILI PER PANNELLI FORATI [A007/11]

Dimensioni 2040 x 498 x 2000h mm

**A008N** € 2630,00

CON PIANO IN ACCIAIO INOX

A007P
€ 4700,00
ARREDAMENTO MODULARE PER OFFICINA

La soluzione ottimale per arredare la tua officina, il tuo garage o il tuo angolo racing

- 4 ARMADI PENSILI CON AMMORTIZZATORI A GAS [A007/01]
- 2 ARMADI ALTI CON 3 PIANI INTERNI [A007/02]
- 1 ARMADIO BASSO A DUE ANTE CON UN PIANO INTERNO [A007/03]
- 1 ARMADIO BASSO MULTIFUNZIONE [A007/06]
- 5 PROFILI DI GIUNZIONE PER PANNELLI FORATI [A007/07]
- 1 PIANO IN LEGNO [A007/09]
- 4 PANNELLI FORATI [A007/10]
- 1 CASSETTIERA A CARRELLO CON 7 CASSETTI SU CUSCINETTI [A007/16]
- 1 PIANO IN LEGNO [A007/19]
- 1 CASSETTIERA A 9 CASSETTI SU CUSCINETTI [A007/20]

Dimensioni 3920 x 498 x 2000h mm

A007Q
€ 2430,00
ARREDAMENTO MODULARE PER OFFICINA

La soluzione ottimale per arredare la tua officina, il tuo garage o il tuo angolo racing

- 2 ARMADI PENSILI CON AMMORTIZZATORI A GAS [A007/01]
- 1 ARMADIO ALTO CON 3 PIANI INTERNI [A007/02]
- 1 CASSETTIERA A 4 CASSETTI SU CUSCINETTI [A007/04]
- 2 PROFILI DI GIUNZIONE PER PANNELLI FORATI [A007/07]
- 1 PIANO IN LEGNO [A007/08]
- 2 PANNELLI FORATI [A007/10]
- 1 PROFILO PER PANNELLI FORATI [A007/11]
- 1 CASSETTIERA A 9 CASSETTI SU CUSCINETTI [A007/20]

Dimensioni 1960 x 498 x 2000h mm

A007R
€ 1040,00
ARREDAMENTO MODULARE PER OFFICINA

La soluzione ottimale per arredare la tua officina, il tuo garage o il tuo angolo racing

- 1 ARMADIO PENSILE CON AMMORTIZZATORI A GAS [A007/01]
- 2 PROFILI DI GIUNZIONE PER PANNELLI FORATI [A007/07]
- 1 PANNELLO FORATO [A007/10]
- 2 PROFILI PER PANNELLI FORATI [A007/11]
- 1 PIANO IN LEGNO [A007/19]
- 1 CASSETTIERA A 9 CASSETTI SU CUSCINETTI [A007/20]

Dimensioni 680 x 498 x 2000h mm

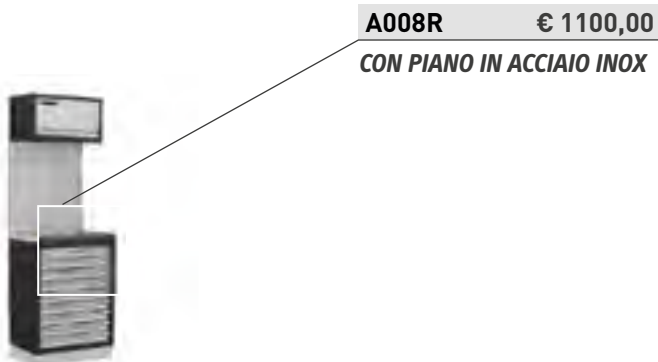
A007S
€ 2820,00
ARREDAMENTO MODULARE PER OFFICINA

La soluzione ottimale per arredare la tua officina, il tuo garage o il tuo angolo racing

- 3 ARMADI PENSILI CON AMMORTIZZATORI [A007/01]
- 1 ARMADIO ALTO CON 3 PIANI INTERNI [A007/02]
- 1 ARMADIO BASSO A DUE ANTE CON UN PIANO INTERNO [A007/03]
- 3 PROFILI DI GIUNZIONE PER PANNELLI FORATI [A007/07]
- 1 PIANO IN LEGNO [A007/09]
- 3 PANNELLI FORATI [A007/10]
- 1 PROFILO PER PANNELLI FORATI [A007/11]
- 1 CASSETTIERA A 9 CASSETTI [A007/20]
- 1 CARRELLO A 3 RIPIANI [A007/22]

Dimensioni 2640 x 498 x 2000h mm



**A007T**

€ 2250,00

ARREDAMENTO MODULARE PER OFFICINA

La soluzione ottimale per arredare la tua officina, il tuo garage o il tuo angolo racing

- 2 ARMADI PENSILI CON AMMORTIZZATORI A GAS [A007/01]
- 1 ARMADIO BASSO A DUE ANTE CON UN PIANO INTERNO [A007/03]
- 1 CASSETTIERA A 5 CASSETTI SU CUSCINETTI [A007/05]
- 2 PROFILI DI GIUNZIONE PER PANNELLI FORATI [A007/07]
- 1 PIANI IN LEGNO [A007/08]
- 2 PANNELLI FORATI [A007/10]
- 1 PROFILO PER PANNELLI FORATI [A007/11]
- 1 ARMADIO ALTO A 2 ANTE CON 3 PIANI INTERNI [A007/23]

Dimensioni

2275 x 498 x 2000h mm

**A008T** € 2350,00

CON PIANO IN ACCIAIO INOX

A007U

€ 2960,00

ARREDAMENTO MODULARE PER OFFICINA

La soluzione ottimale per arredare la tua officina, il tuo garage o il tuo angolo racing

- 3 ARMADI PENSILI CON AMMORTIZZATORI [A007/01]
- 1 ARMADIO ALTO CON 3 PIANI INTERNI [A007/02]
- 1 ARMADIO BASSO A DUE ANTE CON UN PIANO INTERNO [A007/03]
- 3 PROFILI DI GIUNZIONE PER PANNELLI FORATI [A007/07]
- 1 PIANO IN LEGNO [A007/09]
- 3 PANNELLI FORATI [A007/10]
- 1 PROFILO PER PANNELLI FORATI [A007/11]
- 1 CASSETTIERA CON 7 CASSETTI SU CUSCINETTI [A007/17]
- 1 ARMADIO BASSO PER ARROTOLATORI [A007/18]

Dimensioni

2640 x 498 x 2000h mm

**A008U** € 3080,00

CON PIANO IN ACCIAIO INOX

A007UF

€ 3240,00

ARREDAMENTO MODULARE PER OFFICINA

La soluzione ottimale per arredare la tua officina, il tuo garage o il tuo angolo racing

- 3 ARMADI PENSILI CON AMMORTIZZATORI [A007/01]
- 1 ARMADIO ALTO CON 3 PIANI INTERNI [A007/02]
- 1 ARMADIO BASSO A DUE ANTE CON UN PIANO INTERNO [A007/03]
- 3 PROFILI DI GIUNZIONE PER PANNELLI FORATI [A007/07]
- 1 PIANO IN LEGNO [A007/09]
- 3 PANNELLI FORATI [A007/10]
- 1 PROFILO PER PANNELLI FORATI [A007/11]
- 1 CASSETTIERA CON 7 CASSETTI SU CUSCINETTI [A007/17]
- 1 ARMADIO BASSO PER ARROTOLATORI [A007/18]
- 1 AVVOLGICAVO AUTO RIENTRANTE [0621/A3]
- 1 AVVOLGITUBO AUTO RIENTRANTE PER ARIA [0481/15]

Dimensioni

2640 x 498 x 2000h mm

**A008UF** € 3340,00

CON PIANO IN ACCIAIO INOX

A007V

€ 4700,00

ARREDAMENTO MODULARE PER OFFICINA

La soluzione ottimale per arredare la tua officina, il tuo garage o il tuo angolo racing

- 4 ARMADI PENSILI CON AMMORTIZZATORI A GAS [A007/01]
- 2 ARMADI ALTI CON 3 PIANI INTERNI [A007/02]
- 1 CASSETTIERA A 5 CASSETTI SU CUSCINETTI [A007/05]
- 1 ARMADIO BASSO MULTIFUNZIONE [A007/06]
- 5 PROFILI DI GIUNZIONE PER PANNELLI FORATI [A007/07]
- 1 PIANO IN LEGNO [A007/08]
- 4 PANNELLI FORATI [A007/10]
- 1 CASSETTIERA GRANDE ALL'AMERICANA [A007/21]

Dimensioni

3920 x 498 x 2000h mm

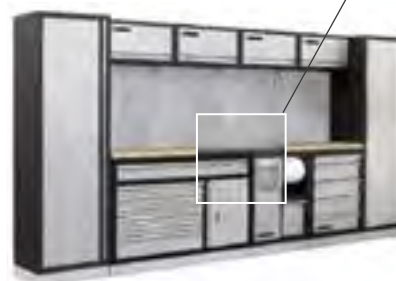
**A008V** € 4890,00

CON PIANO IN ACCIAIO INOX

A007/02 € 624,00

ARMADIO ALTO

Con 3 piani interni



Dimensioni	600 x 458 x 2000 mm
Dimensioni sportello	510 x 1810 mm
Profondità interna	410 mm
Portata max	180 kg

A007/23 € 791,00

ARMADIO ALTO A 2 ANTE

Con 3 piani interni



Dimensioni	915 x 458 x 2000 mm
Dimensioni sportello	510 x 1810 mm
Profondità interna	410 mm
Portata max	300 kg

A007/03 € 313,00

ARMADIO BASSO A DUE ANTE

Con un piano interno



Dimensioni	680 x 458 x 910 mm
Dimensioni sportello	710 x 295 mm
Profondità interna	445 mm
Portata max	60 kg

A007/06 € 394,00

ARMADIO BASSO MULTIFUNZIONE



Dimensioni	680 x 458 x 910 mm
Dimensioni sportello	710 x 295 mm
Profondità interna	445 mm
Dimensioni cassetto	240 x 300 mm
Altezza massima rotolo carta	240 mm
Portata max	90 kg

A007/18 € 481,00

ARMADIO BASSO PER ARROTOLATORI



Dimensioni	680 x 458 x 910 mm
Portata cassetto	30 kg

A007/04 € 504,00

CASSETTIERA A 4 CASSETTI

Su cuscinetti



Dimensioni	680 x 458 x 910 mm
Dimensioni cassetto	550 x 400 mm
Altezza cassetti	1 x 68 mm - 1 x 145 mm - 2 x 214 mm
Portata cassetto	30 kg

A007/05 € 539,00

CASSETTIERA A 5 CASSETTI

Su cuscinetti



Dimensioni	680 x 458 x 910 mm
Dimensioni cassetto	550 x 400 mm
Altezza cassetti	1 x 68 mm - 4 x 145 mm
Portata cassetto	30 kg

A007/17 € 580,00

CASSETTIERA A 7 CASSETTI

Su cuscinetti



Dimensioni	680 x 458 x 910 mm
Dimensioni cassetto	550 x 400 mm
Altezza cassetti	5 x 74.5 mm - 2 x 153.5 mm
Portata cassetto	30 kg

**A007/20****€ 664,00****CASSETTIERA A 9 CASSETTI**

Su cuscinetti



Dimensioni	680 x 458 x 910 mm
Dimensioni cassetto	550 x 400 mm
Altezza cassette	9 x 74,5 mm
Portata cassetto	30 kg

A007/16**€ 624,00****CASSETTIERA A CARRELLO**

Con 7 cassette su cuscinetti



Dimensioni	660 x 455 x 860 mm
Dimensioni cassetto	525 x 400 mm
Profondità interna	6 x 68 mm - 1 x 145 mm
Portata cassetto	30 kg

A007/21I**€ 1140,00****CASSETTIERA GRANDE ALL'AMERICANA**

Con piano in acciaio



Dimensioni	1360 x 458 x 948,5 mm
Dimensioni sportello	535 x 430 mm
Dimensioni cassetto	1 - 1285 x 400 mm 6 - 810 x 400 mm
Altezza cassette	1 x 123,5 mm - 5 x 74,5 mm - 1 x 153,5 mm
Portata cassetto	30 kg

A007/10**€ 88,60****PANNELLO FORATO**

Dimensioni	1052 x 614,5 x 24 mm
Portata max	10 kg

A007/22**€ 253,00****CARRELLO**

A 3 ripiani



Dimensioni	648 x 458 x 865 mm
------------	--------------------

A007/21**€ 1040,00****CASSETTIERA GRANDE ALL'AMERICANA**

Con piano in legno



Dimensioni	1360 x 458 x 945 mm
Dimensioni sportello	535 x 430 mm
Dimensioni cassetto	1 - 1285 x 400 mm 6 - 810 x 400 mm
Altezza cassette	1 x 123,5 mm - 5 x 74,5 mm - 1 x 153,5 mm
Portata cassetto	30 kg

A007/01**€ 180,00****ARMADIO PENSILE**

Con ammortizzatori a gas



Dimensioni	680 x 281 x 350 mm
Dimensioni sportello	610 x 280 mm
Profondità interna	280 mm
Portata max	15 kg

A007/07**€ 22,20****PROFILO DI GIUNZIONE PER PANNELLI FORATI****A007/11****€ 20,00****TERMINALE PER PANNELLI FORATI**

A007-xP

PIANI DI LAVORO

Art.	€	Modulo	Materiale	Dimensioni	Spessore
A007/08	€ 162,00	2	Legno	1360 x 460 mm	35 mm
A007/08I	€ 263,00	2	Acciaio Inox	1360 x 460 mm	35 mm
A007/09	€ 256,00	3	Legno	2040 x 460 mm	35 mm
A007/09I	€ 373,00	3	Acciaio Inox	2040 x 460 mm	35 mm
A007/19	€ 91,80	1	Legno	680 x 460 mm	35 mm
A007/19I	€ 158,00	1	Acciaio Inox	680 x 460 mm	35 mm



A007/LED

€ 41,10

ILLUMINAZIONE LED PER ARREDAMENTO DA OFFICINA

Con nastro bi-adesivo, da utilizzare in accoppiata con il caricabatterie A007/Led/C. Due strisce Led possono essere collegate in serie.



Scatola

A007/LED/C

€ 18,00

ALIMENTATORE PER ILLUMINAZIONE LED



Scatola

P40VD

€ 10,00

PEDANE

In polipropilene componibili, piastrella autobloccante drenante verde



Dimensioni 400 x 400 x 48 mm
Pz. - Pallet 120 = 20 m2

PSV-F

€ 7,20

SCIVOLO IN POLIPROPILENE

Per pedane, verde, femmina (senza ganci)



Dimensioni 205 x 400 x 48 mm

PSV-M

€ 7,20

SCIVOLO IN POLIPROPILENE

Per pedane, verde, maschio (con ganci)



Dimensioni 205 x 400 x 48 mm

PAV

€ 10,10

SCIVOLI AD ANGOLO

Per pedane in polipropilene componibili, kit composto da 4 angolari verdi



4 Pcs



Dimensioni 200 x 200 x 270 x 48 mm

**B015**

€ 548,00

BANCO DA LAVORO IN KIT DI MONTAGGIO

Con piano in lamiera e due cassetti con chiave



Dimensioni banco	1500 x 645 x 865h mm
Spessore gambe	1 mm
Spessore piano	2 mm
Portata	800 kg
Dimensioni cassetto	433 x 347 x 122h mm
Portata cassetto	30 kg
Peso netto	62 kg

B015/10

€ 306,00

BANCO DA LAVORO IN KIT DI MONTAGGIO

Con piano in lamiera e cassetto con chiave



Dimensioni	1000 x 640 x 865h mm
Spessore gambe	2 mm
Spessore piano	2 mm
Portata	600 kg
Dimensioni cassetto	433 x 347 x 122h mm
Portata cassetto	30 kg
Peso netto	55 kg

B022/10

€ 358,00

BANCO DA LAVORO IN KIT DI MONTAGGIO

Con piano in legno pressato e cassetto con chiave



Dimensioni	1000 x 640 x 865h mm
Spessore gambe	2 mm
Spessore piano	38 mm
Portata	350 kg
Dimensioni cassetto	400 x 344 x 125h mm
Portata cassetto	50 kg
Peso netto	47 kg

B022/15

€ 516,00

BANCO DA LAVORO IN KIT DI MONTAGGIO

Con piano in legno pressato e 2 cassetti con chiave



Dimensioni	1500 x 640 x 865h mm
Spessore gambe	2 mm
Spessore piano	38 mm
Portata	350 kg
Dimensioni cassetto	400 x 344 x 125h mm
Portata cassetto	50 kg
Peso netto	75 kg

B017

€ 364,00

BANCO DA LAVORO IN KIT DI MONTAGGIO

Dimensioni banco	1524 x 650 x 845h mm
Spessore gambe	1,0 mm
Spessore piano	40 mm
Portata	280 kg
Peso netto	42,5 kg

B017/C

€ 73,80

CASSETTO IN ACCIAIO CON SERRATURA

Su guide a cuscinetti costruito in acciaio, adattabile su banchi di altre marche



Dimensioni ingombro	680 x 270 x 130 mm
Dimensioni interne	640 x 260 x 90 mm
Portata	18,5 kg
Peso netto	4,3 kg

B009/A1 € 516,00

BANCO DA LAVORO IN KIT DI MONTAGGIO

Con piano in legno pressato, 3 cassetti con chiave e ripiano, piedini regolabili



Dimensioni	1200 x 600 x 865h mm
Spessore gambe	2 mm
Spessore piano	36 mm
Portata	350 kg
Peso netto	62 kg

B009/B1 € 601,00

BANCO DA LAVORO IN KIT DI MONTAGGIO

Con piano in legno pressato, 3 cassetti con chiave e anta con ripiano, piedini regolabili



Dimensioni	1200 x 600 x 865h mm
Spessore gambe	2 mm
Spessore piano	36 mm
Portata	350 kg
Peso netto	64,5 kg

B009/A2 € 813,00

BANCO DA LAVORO IN KIT DI MONTAGGIO

Con piano in legno pressato, 3 cassetti con chiave, anta e ripiano, piedini regolabili



Dimensioni	1690 x 600 x 865 mm
Spessore gambe	2 mm
Spessore piano	36 mm
Portata	350 kg
Peso netto	84 kg

B009/B2 € 854,00

BANCO DA LAVORO IN KIT DI MONTAGGIO

Con piano in legno pressato, 3 cassetti con chiave e 2 ante con ripiano, piedini regolabili



Dimensioni	1690 x 600 x 865 mm
Spessore gambe	2 mm
Spessore piano	36 mm
Portata	350 kg
Peso netto	90 kg

B019 € 548,00

BANCO CHIUDIBILE IN ACCIAIO

Con piano richiudibile aiutato da 2 ammortizzatori ad aria, pannello porta attrezzi 1195 x 458 x 20 mm, altezza massima 1380mm, larghezza massima 1280mm, profondità banco aperto 648mm, profondità banco chiuso 130mm ad un'altezza di 330mm, bloccaggi per piano aperto e chiuso, pannello con fori Ø 4mm, interasse fori 25mm per ganci con filo di Ø 3mm.



Dimensioni piano	1195 x 648 x 41 mm
Interasse fori	25 mm
Portata	225 kg
Peso netto	45 kg

B019/G030 € 11,50

SERIE GANCI



10 Pcs

Lunghezza	30 mm
Interasse dei perni	25 mm



Gx

SERIE GANCI



10 Pcs

Art.	€	Interasse dei perni	Lunghezza
G050	€ 11,50	30 mm	80 mm
G130	€ 16,10	30 mm	155 mm

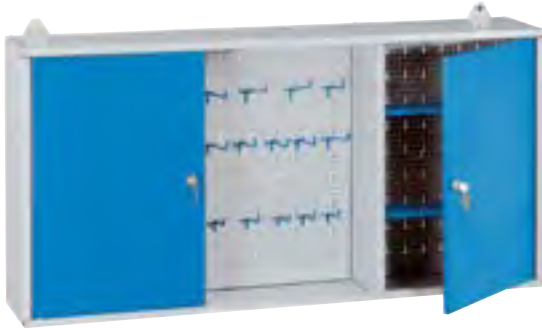

**P009****€ 191,00****ARMADIETTO DA PARETE IN KIT DI MONTAGGIO**

Dimensioni armadietto	1200 x 200 x 600h mm
Spessore lamiera	0,8 mm
Ripiani interni	4
Ganci	18 (6 + 6 + 6)
Interasse fori	30 mm
Peso netto	17 kg

A100**€ 275,00****ARMADIETTO**

Con 1 cassetto su sfere con serratura



Dimensioni armadietto	500 x 460 x 1000h mm
Spessore lamiera	1 mm
Ripiani interni	2
Portata max	100 kg
Portata ripiano	25 kg
Peso netto	35 kg

A300**€ 440,00****ARMADIETTO**

Con 2 cassetti su sfere con serratura



Dimensioni armadietto	1000 x 460 x 1000h mm
Spessore lamiera	1 mm
Ripiani interni	2
Portata max	150 kg
Portata ripiano	25 kg
Peso netto	62 kg

C800**PRO € 947,00****CASSETTIERA PORTA UTENSILI**

Con 8 cassetti su cuscinetti con serratura, senza divisorie



Portata cassetto	50 kg
Dimensioni esterne	630 x 550 x 930h mm
Dimensioni cassetto	517 x 440 mm
Altezza cassetti	8 x 73 mm
Peso netto	58 kg

C600**PRO € 764,00****CASSETTIERA PORTA UTENSILI**

Con 6 cassetti su cuscinetti con serratura, senza divisorie



Portata cassetto	50 kg
Dimensioni esterne	630 x 550 x 930h mm
Dimensioni cassetto	517 x 440 mm
Altezza cassetti	6 x 115 mm
Peso netto	53 kg

C603**PRO € 920,00****CASSETTIERA PORTA UTENSILI**

Con 6 cassetti su cuscinetti con serratura, senza divisorie



Portata cassetto	50 kg
Dimensioni esterne	630 x 550 x 930h mm
Dimensioni cassetto	517 x 440 mm
Altezza cassetti	3 x 73 mm - 2 x 115 mm - 1 x 175 mm
Peso netto	53,5 kg

C800- PRO

SEPARATORI PER CASSETTO "A"

Esempi di composizione dei separatori



10 Pcs

Art.	€	Separatore longitudinale	Separatore trasversale
C800/CC	€ 56,70	440 x 70h mm	-
C800/LL	€ 62,40	-	517 x 70h mm



C600- PRO

SEPARATORI PER CASSETTO "B"

Esempi di composizione dei separatori



10 Pcs

Art.	€	Separatore longitudinale	Separatore trasversale
C600/C	€ 123,00	440 x 110h mm	-
C600/L	€ 28,40	-	120 x 110h mm



C603- PRO

SEPARATORI PER CASSETTO "C"

Esempi di composizione dei separatori



10 Pcs

Art.	€	Separatore longitudinale	Separatore trasversale
C603/C	€ 162,00	440 x 165h mm	-
C603/L	€ 33,90	-	120 x 165h mm



C080-

CASSETTIERE CON CASSETTI ESTRAIBILI TRASPARENTI

Modulari ed impilabili



Art.	€	Dimensioni esterne	Dimensioni cassetto	Numero cassette
C080/3	€ 61,00	382 x 290 x 230h mm	372 x 285 x 73h mm	3
C080/6	€ 60,60	382 x 290 x 230h mm	184 x 285 x 73h mm	6
C080/9	€ 61,80	382 x 290 x 230h mm	122 x 285 x 73h mm	9

C700 € 618,00

CASSETTIERA IN ACCIAIO CON VALIGETTE IN PLASTICA

Vano inferiore con serratura, vano superiore con 7 valigette con serratura centrale 4 x C360 + 3 x C371.



Dimensioni	490 x 343 x 987h mm
Peso netto	27 kg

C085-

CASSETTIERE CON CASSETTI ESTRAIBILI TRASPARENTI

Modulari ed impilabili



Art.	€	Dimensioni esterne	Dimensioni cassetto	Numero cassette
C085/12	€ 37,00	382 x 148 x 230h mm	122 x 145 x 55h mm	12
C085/16	€ 37,00	382 x 148 x 230h mm	90 x 145 x 55h mm	16
C085/24	€ 41,60	382 x 148 x 230h mm	59 x 145 x 55h mm	24

**C086/01C**

€ 16,80

CASSETTIERA MODULARE CON CASSETTI ESTRAIBILI

Collegabile con altre cassettiere tramite guide per creare combinazioni infinite. Dotata di bloccaggio dei cassetti per evitare la caduta accidentale del contenuto e fori di fissaggio posteriori per l'aggancio a muro. Costruita in plastica resistente è adatta all'utilizzo in cantiere, domestico e per l'officina.



Dimensioni	295 x 165 x 200h mm
Numero cassetti	1
Dimensioni cassetto	250 x 150 x 150 mm

**C086/01T**

€ 16,80

CASSETTIERA MODULARE CON VASSOI ESTRAIBILI

Collegabile con altre cassettiere tramite guide per creare combinazioni infinite. Dotata di bloccaggio dei vassoi per evitare la caduta accidentale del contenuto e fori di fissaggio posteriori per l'aggancio a muro. Costruita in plastica resistente è adatta all'utilizzo in cantiere, domestico e per l'officina.



Dimensioni	295 x 165 x 200h mm
Numero cassetti	1
Dimensioni cassetto	250 x 160 x 150 mm

C086/02C

€ 19,00

CASSETTIERA MODULARE CON CASSETTI ESTRAIBILI

Collegabile con altre cassettiere tramite guide per creare combinazioni infinite. Dotata di bloccaggio dei cassetti per evitare la caduta accidentale del contenuto e fori di fissaggio posteriori per l'aggancio a muro. Costruita in plastica resistente è adatta all'utilizzo in cantiere, domestico e per l'officina.



Dimensioni	295 x 165 x 200h mm
Numero cassetti	2
Dimensioni cassetto	250 x 160 x 70 mm

C086/02T

€ 19,50

CASSETTIERA MODULARE CON VASSOI ESTRAIBILI

Collegabile con altre cassettiere tramite guide per creare combinazioni infinite. Dotata di bloccaggio dei vassoi per evitare la caduta accidentale del contenuto e fori di fissaggio posteriori per l'aggancio a muro. Costruita in plastica resistente è adatta all'utilizzo in cantiere, domestico e per l'officina.



Dimensioni	295 x 165 x 200h mm
Numero cassetti	2
Dimensioni cassetto	250 x 160 x 70 mm

C086/04C

€ 20,00

CASSETTIERA MODULARE CON CASSETTI ESTRAIBILI

Collegabile con altre cassettiere tramite guide per creare combinazioni infinite. Dotata di bloccaggio dei cassetti per evitare la caduta accidentale del contenuto e fori di fissaggio posteriori per l'aggancio a muro. Costruita in plastica resistente è adatta all'utilizzo in cantiere, domestico e per l'officina.



Dimensioni	295 x 165 x 200h mm
Numero cassetti	4
Dimensioni cassetto	120 x 160 x 70 mm

C086/04T

€ 22,20

CASSETTIERA MODULARE CON VASSOI ESTRAIBILI

Collegabile con altre cassettiere tramite guide per creare combinazioni infinite. Dotata di bloccaggio dei vassoi per evitare la caduta accidentale del contenuto e fori di fissaggio posteriori per l'aggancio a muro. Costruita in plastica resistente è adatta all'utilizzo in cantiere, domestico e per l'officina.



Dimensioni	295 x 165 x 200h mm
Numero cassetti	4
Dimensioni cassetto	120 x 160 x 70 mm

C086/12C

€ 23,20

CASSETTIERA MODULARE CON CASSETTI ESTRAIBILI

Collegabile con altre cassettiere tramite guide per creare combinazioni infinite. Dotata di bloccaggio dei cassetti per evitare la caduta accidentale del contenuto e fori di fissaggio posteriori per l'aggancio a muro. Costruita in plastica resistente è adatta all'utilizzo in cantiere, domestico e per l'officina.



Dimensioni	295 x 165 x 200h mm
Numero cassetti	12
Dimensioni cassetto	60 x 160 x 50 mm

C086/04C/D**NEW** € 1,90**KIT DIVISORI PER CASSETTIERA MODULARE**

4 Pcs

Dimensioni	111 x 63 mm
Pack	5

C086/12C/D**NEW** € 3,04**KIT DIVISORI PER CASSETTIERA MODULARE**

12 Pcs

Dimensioni	49.5 x 41 mm
Pack	5

C090-

CONTENITORE UNIVERSALE

Modulare ed impilabile



Art.	€	Dimensioni
C090/2	€ 2,66	108 x 167 x 75h mm
C090/3	€ 5,30	151 x 237 x 126h mm
C090/4	€ 11,80	213 x 350 x 164h mm
C090/5	€ 19,50	310 x 490 x 190h mm
C090/6	€ 39,20	380 x 610 x 250h mm

0849

€ 239,00

SERIE BAULI IN ALLUMINIO

Con maniglie ergonomiche e serratura con chiave.



3 Pcs

Alu

Alluminio

Dimensioni bauli	730 x 380 x 360h mm - 680 x 310 x 320h mm - 475 x 260 x 210h mm
Peso netto	14 kg

C087

€ 228,00

CARRELLO PORTA UTENSILI

Separabile in 3 pezzi.



Acciaio

Dimensioni	560 x 350 x 770h mm
Portata	40 kg
Peso netto	14 kg

0382-

BAULI IN ALLUMINIO

Con serratura con chiave.



0363-

BAULE IN ACCIAIO

Lucchettabili.



Art.	€	Dimensioni esterne	Dimensioni interne	Peso netto
0382	€ 1000,00	760 x 335 x 250h mm, 1240 x 385 x 385h mm, 1445 x 520 x 460h mm	710 x 285 x 225h mm, 1185 x 335 x 365h mm, 1395 x 435 x 440h mm	40 kg
0382/02	€ 180,00	760 x 335 x 250h mm	745 x 310 x 225h mm	6 kg
0382/03	€ 306,00	1240 x 385 x 385h mm	1185 x 335 x 365h mm	14 kg
0382/04	€ 543,00	1445 x 520 x 460h mm	1405 x 365 x 440h mm	21 kg

Art.	€	Dimensioni esterne	Dimensioni interne	Peso netto
0363	€ 1040,00	770 x 420 x 305h mm, 915 x 440 x 565h mm, 1220 x 620 x 700h mm	750 x 400 x 300h mm, 825 x 350 x 430h mm, 1130 x 520 x 600h mm	107 kg
0363/30	€ 190,00	770x420x305h mm	750 x 400 x 300h mm	14,5 kg
0363/36	€ 243,00	915 x 440 x 565h mm	825 x 350 x 430h mm	35 kg
0363/48	€ 686,00	1220 x 620 x 700h mm	1130 x 520 x 600h mm	57 kg

**C670****€ 1170,00****BANCO MOBILE**

Composto da 6 cassetti con guide su sfere, armadietto con 2 cassetti, 2 ruote fisse e 2 girevoli, portarotolo carta



Dimensioni	1200 x 460 x 1060h mm
Dimensioni piano	1020 x 455 x 15h mm
Dimensioni armadietto	320 x 410 x 630h mm
Cassetti armadietto	n°2 290 x 400 x 65h mm
Portata cassetto	25 kg
Dimensioni cassetto	1 - 900 x 405 mm 5 - 535 x 405 mm
Altezza cassetti	1 x 85 mm - 1 x 40 mm - 2 x 70 mm - 1 x 150 mm - 1 x 230 mm
Peso netto	97 kg

C190**€ 791,00****CARRELLO A 7 CASSETTI**

Con sistema antiribaltamento. si può aprire un solo cassetto alla volta; piano di lavoro in materiale plastico e legno con pratici scomparti, mensola a scomparsa e vano porta attrezzi o bombole su di un lato, porta cacciaviti e vano porta attrezzi o bombole sull'altro lato



Dimensioni esterne	1000 x 470 x 920h mm
Dimensioni cassetto	560 x 400 mm
Altezza cassetti	1 x 170 mm - 2 x 40 mm - 4 x 60 mm
Peso netto	73 kg

C980**€ 1030,00****CARRELLO PORTA UTENSILI**

A 7 cassetti, con due armadi laterali provvisti di 12 ganci e 10 contenitori portaminuteria estraibili, bloccaggio di sicurezza su ogni cassetto, guide su cuscinetti, serratura centrale, 2 ruote fisse e 2 girevoli



Portata cassetto	25 kg
Dimensioni cassettiera	890 x 530 x 1030h mm
Dimensioni cassetto	565 x 405 mm
Altezza cassetti	3 x 50 mm - 3 x 105 mm - 1 x 165 mm
Peso netto	100 kg

C960/F6**€ 538,00****CARRELLO PORTA UTENSILI A 6 CASSETTI**

Con cassetti di sicurezza anti-ribaltamento con guide su sfere, serratura centrale, portarotolo e vassoio, 2 ruote fisse e 2 girevoli



Dimensioni	890 x 458 x 994 mm
Dimensioni cassetto	565 x 405 mm
Altezza cassetti	3 x 65 mm - 3 x 145 mm
Portata cassetto	25 kg
Peso netto	61 kg

C960/F7

€ 591,00

CARRELLO PORTA UTENSILI A 7 CASSETTI

Con cassetti di sicurezza anti-ribaltamento con guide su sfere, serratura centrale, portarotolo e vassoio, 2 ruote fisse e 2 girevoli



C960/F8

€ 643,00

CARRELLO PORTA UTENSILI A 8 CASSETTI

Con cassetti di sicurezza anti-ribaltamento con guide su sfere, serratura centrale, portarotolo e vassoio, 2 ruote fisse e 2 girevoli



Dimensioni	890 x 458 x 994 mm
Dimensioni cassetto	565 x 405 mm
Altezza cassetti	5 x 65 mm - 2 x 145 mm
Portata cassetto	25 kg
Peso netto	62 kg

Dimensioni	890 x 458 x 994 mm
Dimensioni cassetto	565 x 405 mm
Altezza cassetti	7 x 65 mm - 1 x 145 mm
Portata cassetto	25 kg
Peso netto	65 kg

C960/B6

€ 538,00

CARRELLO PORTA UTENSILI A 6 CASSETTI

Con cassetti di sicurezza anti-ribaltamento con guide su sfere, serratura centrale, portarotolo e vassoio, 2 ruote fisse e 2 girevoli



C960/B7

€ 591,00

CARRELLO PORTA UTENSILI A 7 CASSETTI

Con cassetti di sicurezza anti-ribaltamento con guide su sfere, serratura centrale, portarotolo e vassoio, 2 ruote fisse e 2 girevoli



Dimensioni	890 x 458 x 994 mm
Dimensioni cassetto	565 x 405 mm
Altezza cassetti	3 x 65 mm - 3 x 145 mm
Portata cassetto	25 kg
Peso netto	61 kg

Dimensioni	890 x 458 x 994 mm
Dimensioni cassetto	565 x 405 mm
Altezza cassetti	5 x 65 mm - 2 x 145 mm
Portata cassetto	25 kg
Peso netto	62 kg

**C960/B8****€ 643,00****CARRELLO PORTA UTENSILI A 8 CASSETTI**

Con cassetti di sicurezza anti-ribaltamento con guide su sfere, serratura centrale, portarotolo e vassoio, 2 ruote fisse e 2 girevoli



Dimensioni	890 x 458 x 994 mm
Dimensioni cassetto	565 x 405 mm
Altezza cassetti	7 x 65 mm - 1 x 145 mm
Portata cassetto	25 kg
Peso netto	65 kg

C900/A**€ 285,00****CASSETTA ATTREZZI**

Con 6 cassetti con serratura centrale e vassoio portatile



Dimensioni	660 x 322 x 380h mm
Dimensioni cassetto	2 - 174 x 285 mm 1 - 232 x 285 mm 3 - 580 x 285 mm
Altezza cassetti	5 x 45 mm - 1 x 70 mm
Peso netto	22 kg

C900/B**€ 438,00****CARRELLO PORTA UTENSILI**

Composto da 6 cassetti con serratura centrale 2 ruote fisse e 2 girevoli



Dimensioni	685 x 455 x 850h mm
Portata cassetto	25 kg
Dimensioni cassetto	585 x 410 mm
Altezza cassetti	2 x 45 mm - 2 x 100 mm - 2 x 150 mm
Peso netto	44 kg

C902/B**€ 349,00****CARRELLO PORTA UTENSILI**

Composto da 3 cassetti e vano inferiore porta attrezzi, con serratura centrale, 2 ruote fisse e 2 girevoli



Dimensioni del vano	575 x 430 x 315h mm
Dimensioni	680 x 435 x 780h mm
Portata cassetto	25 kg
Peso netto	27 kg

0466/4V € 35,40

SERIE VASSOI MAGNETICI

In acciaio verniciato, per organizzare al meglio lo spazio di lavoro



Dimensioni ingombro	310 x 130 x 120h mm; 270 x 130 x 120h mm; 210 x 130 x 120h mm; 150 x 130 x 120h mm
Capacità	1,17 kg; 1 kg; 0,77 kg; 0,6 kg
Spessore lamiera	0,7 mm

0466/PB € 8,50

PORTA BUSSOLE MAGNETICO

In acciaio verniciato, per organizzare al meglio lo spazio di lavoro



Dimensioni ingombro	280 x 45 x 90h mm
Misure bussole	1/4" - 3/8" - 1/2"
Spessore lamiera	0,9 mm

0323/45 € 49,10

CASSETTA ATTREZZI

A 5 scomparti.



Dimensioni	450 x 200 x 205 h mm
Peso netto	4 kg

0423/1 € 32,80

VALIGETTA PORTAMINUTERIA

Con 16 contenitori plastici estraibili piccoli e 4 medi, con dimensioni rispettivamente di 54 x 52 x 43h mm e 54 x 105 x 43h mm. La valigetta, ideale per riporre minuteria, ha due chiusure di sicurezza per evitare il rovesciamento involontario della minuteria.



Dimensioni	334 x 240 x 45 mm
------------	-------------------

0466/CV € 14,80

VASSOIO MAGNETICO CON PORTA GIRAVITI

In acciaio verniciato, per organizzare al meglio lo spazio di lavoro



Dimensioni	360 x 130 x 110h mm
Dimensioni cassetto	305 x 115 x 30h mm
Fori	6 x Ø 10 mm
Capacità	3,18 kg
Spessore lamiera	1 mm

0466/SC € 16,80

SUPPORTO MAGNETICO PER 3 BOMBOLETTE SPRAY E 7 GIRAVITI

In acciaio verniciato, per organizzare al meglio lo spazio di lavoro



Dimensioni ingombro	130 x 300 x 130h mm
Fori	3 x Ø 75 mm; 2 x Ø 12 mm; 1 x Ø 11 mm; 1 x Ø 10 mm; 1 x Ø 9 mm; 2 x Ø 7,5 mm
Capacità	1,19 kg
Spessore lamiera	0,8 mm

0323/55 € 55,70

CASSETTA ATTREZZI

A 5 scomparti.



Dimensioni	550 x 200 x 205h mm
Peso netto	4,5 kg

0423/2 € 38,70

VALIGETTA PORTAMINUTERIA

Con 29 contenitori plastici estraibili piccoli e 3 medi, con dimensioni rispettivamente di 54 x 52 x 43h mm e 54 x 105 x 43h mm. La valigetta, ideale per riporre minuteria, ha una chiusura di sicurezza centrale per evitare il rovesciamento involontario della minuteria.



Dimensioni	388 x 295 x 45 mm
------------	-------------------

**0422-****SERIE CONTENITORI BIVALVE**

Pratiche per immagazzinare piccoli oggetti come viti, bulloni, dadi, gancetti, chiodi

**Plastic**

made in Italy

20 Pcs

Art.	€	Dimensioni
0422/B1	€ 9,20	65 x 47 x 30 mm
0422/B3	€ 16,10	75 x 60 x 40mm

C312**€ 8,50****VALIGETTA PORTA MINUTERIA**

Con 21 scomparti e divisorie rimovibili, per poter immagazzinare oggetti più grandi dello scomparto originale

**Plastic**

Dimensioni 320 x 260 x 50 mm

C315**€ 13,20****VALIGETTA PORTA MINUTERIA**

Con 21 scomparti e divisorie rimovibili, per poter immagazzinare oggetti più grandi dello scomparto originale

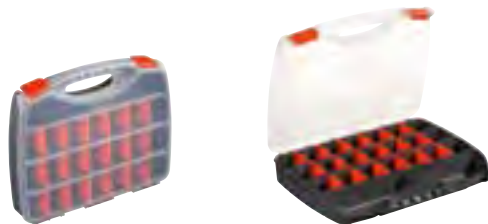
**Plastic**

Dimensioni 380 x 310 x 60 mm

C313**€ 73,80****CASSETTIERA CON 4 VALIGETTE PORTA MINUTERIA**

Cassettera modulare, con 13 vaschette estraibili di varie dimensioni dotata di incastri laterali per la sovrapposizione e fori posteriori per il fissaggio a muro

**Plastic**

Dimensioni 377 x 265 x 310 mm

C360**€ 24,90****VALIGETTA PORTA MINUTERIA**

Con 23 scomparti e 16 separatori rimovibili

**Plastic**

made in Italy

Scatola

Dimensioni 443 x 317 x 80h mm

C371**€ 40,60****VALIGETTA PORTA MINUTERIA**

Con 2 vaschette grandi, 3 vaschette medie, 6 vaschette piccole estraibili

**Plastic**

made in Italy

Scatola

Dimensioni 443 x 317 x 107h mm

C163**€ 15,30****VALIGETTA PER UTENSILI**

Lucchettabile, 16", con vaschetta mobile e 2 scomparti porta minuteria nel coperchio

**PP**

made in Italy

Scatola

Poliprop.

Dimensioni 394 x 160 x 195h mm

C165**€ 29,00****VALIGETTA PER UTENSILI**

20" con vaschetta mobile e 2 scomparti porta minuteria nel coperchio

**PP**

made in Italy

Scatola

Poliprop.

Dimensioni 514 x 225 x 260h mm

C648 € 56,20

VALIGETTA PER UTENSILI

Con vaschetta mobile



Scatola	
Dimensioni	510 x 280 x 220h mm

M13x

VALIGIA RESISTENTE ALL'ACQUA

Valigia porta strumenti a tenuta stagna, con valvola di depressurizzazione, interno personalizzabile con spugna pretagliata a cubetti per alloggiare qualsiasi tipo di strumento



Art.	€	Dimensioni esterne	Dimensioni interne	Peso netto
M138	€ 66,80	465 x 360 x 175h mm	425 x 287 x 115h mm	2,9 kg
M139	€ 91,60	570 x 410 x 215h mm	505 x 353 x 140h mm	4,5 kg

M300/B € 89,60

VALIGIA RESISTENTE ALL'ACQUA

Con valvola di depressurizzazione, interno personalizzabile con spugna pretagliata a cubetti per alloggiare qualsiasi tipo di oggetto. La sua superiore resistenza agli urti, acqua e polvere la rende adatta a vari settori di utilizzo ed applicazioni



Dimensioni esterne	336 x 300 x 148 mm
Dimensioni interne	300 x 225 x 132 mm
Volume interno	8.91 l
Temperatura di esercizio	-30 / 90°C (-22 / 194°F)
Peso netto	1,6 kg

M430/B € 121,00

VALIGIA RESISTENTE ALL'ACQUA

Con valvola di depressurizzazione, interno personalizzabile con spugna pretagliata a cubetti per alloggiare qualsiasi tipo di oggetto. La sua superiore resistenza agli urti, acqua e polvere la rende adatta a vari settori di utilizzo ed applicazioni



Dimensioni esterne	464 x 366 x 176 mm
Dimensioni interne	426 x 290 x 159 mm
Volume interno	19.64 l
Temperatura di esercizio	-30 / 90°C (-22 / 194°F)
Peso netto	2,8 kg

M505/B € 185,00

VALIGIA RESISTENTE ALL'ACQUA

Con valvola di depressurizzazione, interno personalizzabile con spugna pretagliata a cubetti per alloggiare qualsiasi tipo di oggetto. La sua superiore resistenza agli urti, acqua e polvere la rende adatta a vari settori di utilizzo ed applicazioni



Dimensioni esterne	555 x 428 x 211 mm
Dimensioni interne	500 x 350 x 194 mm
Volume interno	33.95 l
Temperatura di esercizio	-30 / 90°C (-22 / 194°F)
Peso netto	3,9 kg

M540/BT € 301,00

VALIGIA RESISTENTE ALL'ACQUA CON TROLLEY

Con valvola di depressurizzazione, interno personalizzabile con spugna pretagliata a cubetti per alloggiare qualsiasi tipo di oggetto. La sua superiore resistenza agli urti, acqua e polvere la rende adatta a vari settori di utilizzo ed applicazioni



Dimensioni esterne	594 x 473 x 270 mm
Dimensioni interne	538 x 405 x 245 mm
Volume interno	53.38 l
Temperatura di esercizio	-30 / 90°C (-22 / 194°F)
Peso netto	5,2 kg

**0682**

€ 98,60

VALIGIA PORTA UTENSILI IN ABS

Utensili non inclusi



ABS

Scatola

A	460 mm
B	330 mm
C	150 mm
D	98 mm
E	52 mm
Portata	25 kg
Peso netto	2,9 kg

0683

€ 168,00

VALIGIA PORTA UTENSILI IN ABS CON CARRELLO

Utensili non inclusi



ABS

Scatola

A	460 mm
B	330 mm
C	190 mm
D	98 mm
E	92 mm
Portata	25 kg
Peso netto	4,5 kg

068x**VALIGIA PORTA UTENSILI IN ALLUMINIO**

Utensili non inclusi

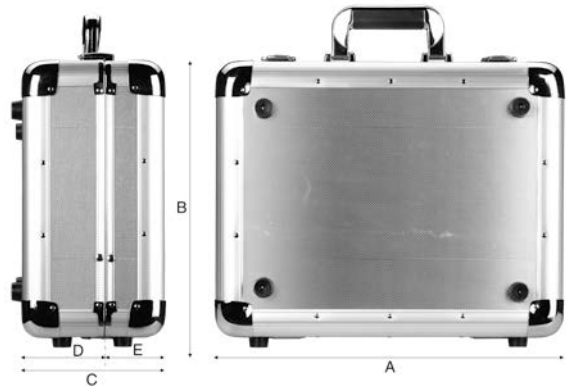

Art.	€	A	B	C	D	E	Portata	Peso netto
0680	€ 137,00	510 mm	375 mm	185 mm	110 mm	75 mm	30 kg	5 kg
0681	€ 118,00	440 mm	390 mm	185 mm	110 mm	75 mm	30 kg	4,8 kg

0557

€ 94,90

ZAINO MULTIFUNZIONE

Realizzato in poliestere 1680 denari, con base in gomma rigida, schienale traspirante, portautensili estraibile, tasca porta computer imbottita con zona ufficio, tasche capienti e robuste per alloggiare un gran numero di utensili



Dimensioni esterne 370 x 160 x 460h mm
Peso netto 2,2 kg

0395

€ 56,20

BORSA PORTA UTENSILI

Con tracolla in poliestere 1680 denari, tasche capienti e robuste per alloggiare un gran numero di utensili.



Tasche 19
Dimensioni 480 x 250 x 225h mm / 19" x 10" x 9" h mm

0254

€ 8,70

BORSA INSTALLATORE

In pelle con cintura



Tasche 5

0390

€ 45,70

BORSA PORTA UTENSILI

Con tracolla in poliestere 1680 denari, tasche capienti e robuste per alloggiare un gran numero di utensili.



Tasche 14
Dimensioni 400 x 225 x 250h mm

0409

€ 11,80

BORSA PORTA UTENSILI

A 10 tasche con cintura, costruita in poliestere. si può usare per contenere piccoli tester, pinze, forbici, cacciaviti e utensili vari



Dimensioni 250 x 210 x 70 mm

0264

€ 17,70

BORSA INSTALLATORE

In pelle con cintura



Tasche 11

0036-**MORSA IN ACCIAIO**

Si attacca direttamente alla base di lavoro per garantire un'elevata stabilità. Regolazione laterale dello scorrimento.



Art.	€	Ganasce	Apertura	Altezza utile	Interasse fori	Peso netto
0036/100	€ 114,00	100 mm	105 mm	60 mm	85 mm	4,9 kg
0036/125	€ 169,00	125 mm	138 mm	75 mm	110 mm	9,5 kg
0036/150	€ 285,00	150 mm	180 mm	90 mm	150 mm	19 kg

0036-xG**MORSA GIREVOLE IN ACCIAIO**

Si attacca direttamente alla base di lavoro per garantire un'elevata stabilità. Regolazione laterale dello scorrimento. Dotata di meccanismo girevole.



Art.	€	Ganasce	Apertura	Peso netto
0036/100G	€ 134,00	100 mm	105 mm	5,5 kg
0036/125G	€ 184,00	125 mm	124 mm	11 kg
0036/150G	€ 316,00	150 mm	180 mm	22 kg

0135-**MORSA IN ACCIAIO FORGIATA**

Si attacca direttamente alla base di lavoro per garantire un'elevata stabilità. Regolazione laterale dello scorrimento.



Art.	€	Ganasce	Apertura	Altezza utile	Interasse fori	Peso netto
0135/100	€ 122,00	100 mm	125 mm	60 mm	98 mm	5,8 kg
0135/125	€ 173,00	125 mm	160 mm	70 mm	111 mm	9,8 kg
0135/150	€ 275,00	150 mm	190 mm	85 mm	136 mm	17,8 kg

0140-**MORSA IN ACCIAIO**

Si attacca direttamente alla base di lavoro per garantire un'elevata stabilità. Regolazione laterale dello scorrimento. Dotata di stringitubo. Consigliata per utilizzi gravosi.



Art.	€	Ganasce	Apertura	Altezza utile	Interasse fori	Peso netto
0140/080	€ 45,80	80 mm	80 mm	60 mm	81 mm	4 kg
0140/100	€ 53,50	100 mm	100 mm	65 mm	81 mm	5,5 kg
0140/125	€ 79,00	125 mm	125 mm	90 mm	103 mm	10 kg
0140/150	€ 99,40	150 mm	150 mm	95 mm	123 mm	14 kg

0591-**PRO****MORSA IN ACCIAIO**

Si attacca direttamente alla base di lavoro per garantire un'elevata stabilità. Regolazione laterale dello scorrimento. Dotata di cuscinetto sulla vite, stringitubo e ganasce intercambiabili.



Art.	€	Ganasce	Apertura	Peso netto
0591/100	€ 151,00	100 mm	95 mm	5,3 kg
0591/125	€ 213,00	125 mm	130 mm	11 kg
0591/150	€ 321,00	150 mm	230 mm	23 kg

0145-**MORSA IN ACCIAIO**

Si attacca direttamente alla base di lavoro per garantire un'elevata stabilità. Dotata di stringitubo.



Art.	€	Ganasce	Stringitubo	Apertura	Altezza utile	Interasse fori	Peso netto
0145/80	€ 38,70	80 x 20 mm	No	80 mm	58 mm	76 mm	3,7 kg
0145/100	€ 43,00	100 x 20 mm	Si	100 mm	70 mm	85 mm	5,2 kg
0145/125	€ 57,20	125 x 20 mm	Si	125 mm	75 mm	90 mm	7,4 kg
0145/150	€ 93,10	150 x 27 mm	Si	150 mm	95 mm	105 mm	12 kg

0174-**MORSA DA BANCO IN GHISA SFEROIDALE**

Si attacca direttamente alla base di lavoro per garantire un'elevata stabilità. Dotata di ganasce intercambiabili.



Art.	€	Ganasce	Apertura	Altezza utile	Interasse fori	Peso netto
0174/100	€ 61,10	100 x 20 mm	100 mm	50 mm	85 mm	4,8 kg
0174/125	€ 76,20	125 x 22 mm	130 mm	60 mm	95 mm	7,7 kg
0174/150	€ 95,30	150 x 22 mm	150 mm	75 mm	105 mm	10 kg

0427-**MORSA PARALLELA DA BANCO IN GHISA SFEROIDALE**

Si attacca direttamente al bordo del banco di lavoro per garantire un'elevata stabilità. Dotata di ganasce intercambiabili e guide prismatiche.



Art.	€	Ganasce	Apertura	Peso netto
0427/080	€ 71,40	80 mm	80 mm	6,5 kg
0427/100	€ 92,00	100 mm	100 mm	10 kg
0427/125	€ 122,00	135 mm	125 mm	12 kg

0146/60 € 25,20

MORSA GIREVOLE CON MORSETTO



Ghisa

Ganasce	60 mm
Apertura	65 mm
Capacità morsetto	51 mm
Peso netto	1,5 kg

0042-

COPPIA DI COPRIGANASCE MAGNETICHE IN ALLUMINIO

Rigate con scanalature



Alu

2 Pcs Alluminio

Art.	€	Ganasce	Altezza	Spessore
0042/100	€ 12,70	100 mm	28 mm	7.5 mm
0042/125	€ 19,60	125 mm	28.5 mm	7.5 mm
0042/150	€ 20,10	150 mm	28.5 mm	7.5 mm

0520-xG

COPPIA DI COPRIGANASCE MAGNETICHE IN ALLUMINIO RIVESTITE IN GOMMA

Con gomma resistente



2 Pcs



Blister

Alu

Alluminio

Art.	€	Lunghezza	Altezza	Spessore
0520/100G	€ 14,10	100 mm	28,7 mm	10,0 mm
0520/125G	€ 16,00	125 mm	28,7 mm	10,0 mm
0520/150G	€ 17,80	150 mm	28,7 mm	10,0 mm

0520-xA

COPPIA DI COPRIGANASCE MAGNETICHE IN ALLUMINIO

Rigate con scanalature



2 Pcs



Blister

Alu

Alluminio

Art.	€	Lunghezza	Altezza	Spessore
0520/100A	€ 14,10	100 mm	28,3 mm	8,9 mm
0520/125A	€ 16,00	125 mm	28,3 mm	8,9 mm
0520/150A	€ 17,80	150 mm	28,3 mm	8,9 mm

0520-xP

COPPIA DI COPRIGANASCE PRISMATICHE MAGNETICHE

Con ganasce trapezoidali



2 Pcs



Blister

Alu

Alluminio

Art.	€	Lunghezza	Altezza	Spessore
0520/100P	€ 14,10	100 mm	28,5 mm	9,8 mm
0520/125P	€ 16,00	125 mm	28,5 mm	9,8 mm
0520/150P	€ 17,80	150 mm	28,5 mm	9,8 mm

0520-xF

COPPIA DI COPRIGANASCE MAGNETICHE RIVESTITE IN FIBRA

Con fibra resistente



2 Pcs



Blister

Alu

Alluminio

Art.	€	Lunghezza	Altezza	Spessore
0520/100F	€ 14,10	100 mm	28,7 mm	10,3 mm
0520/125F	€ 16,00	125 mm	28,7 mm	10,3 mm
0520/150F	€ 17,80	150 mm	28,7 mm	10,3 mm

0520-xS

SERIE DI COPPIE DI COPRIGANASCE MAGNETICHE IN ALLUMINIO

Comprende gli articoli 0520-xA, 0520-xF, 0520-xG, 0520-xP.



8 Pcs



Blister

Alu

Alluminio

Art.	€	Lunghezza
0520/100S	€ 42,30	100 mm
0520/125S	€ 48,00	125 mm
0520/150S	€ 53,50	150 mm



0205

€ 31,30

MORSA PER SALDARE PROFILATI A 90°

Ganascia regolabile



Alu

Alluminio

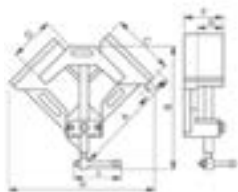

Capacità 70 mm + 70 mm

Altezza utile 35 mm

A 150 mm

B Min 250 mm - Max 345 mm

C 97 mm

D 60 mm

E 70 mm

F 55 mm

G 49 mm

H 217 mm

J 92 mm

0205/120**PRO** € 108,00**MORSA PER SALDARE PROFILATI A 90°**

Ganascia regolabile.



Ghisa

Ghisa

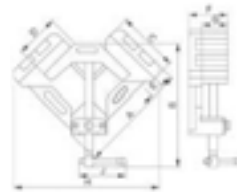

Capacità 110 mm + 110 mm

Altezza utile 60 mm

A 257 mm

B Min 290 mm - Max 458 mm

C 135 mm

D 109 mm

E 126 mm

F 90 mm

G 77 mm

H 340 mm

J 112 mm

M006-**MORSETTO IN ACCIAIO TEMPERATO PER MECCANICA**

Acciaio



Temprato

Art.	€	Apertura x Profondità	Stelo
M006/200	€ 27,20	200 x 120 mm	22 x 10,5 mm
M006/300	€ 38,10	300 x 140 mm	25 x 12 mm
M006/400	€ 38,60	420 x 120 mm	25 x 12 mm
M006/500	€ 42,90	500 x 120 mm	25 x 12 mm
M006/600	€ 61,60	600 x 120 mm	25 x 12 mm
M006/800	€ 74,00	800 x 120 mm	25 x 12 mm
M006/1000	€ 87,90	1000 x 120 mm	25 x 12 mm

**M007-****MORSETTO IN ACCIAIO TEMPERATO PER MECCANICA**

A serraggio rapido.



Acciaio



Temprato

Art.	€	Apertura x Profondità	Stelo
M007/250	€ 53,30	250 x 120 mm	22 x 10,5 mm
M007/300	€ 61,60	300 x 140 mm	25 x 12 mm
M007/400	€ 67,20	400 x 120 mm	25 x 12 mm
M007/500	€ 72,40	500 x 120 mm	25 x 12 mm
M007/600	€ 80,60	600 x 120 mm	25 x 12 mm

**M018-****MORSETTO IN ACCIAIO TEMPERATO PER MECCANICA E FALEGNAMERIA**

Acciaio



Temprato

Art.	€	Apertura x Profondità	Stelo
M018/0200	€ 20,40	200 x 100 mm	19 x 9,5 mm
M018/0300	€ 24,50	300 x 100 mm	19 x 9,5 mm
M018/0400	€ 27,90	400 x 120 mm	21,5 x 10,5 mm
M018/0500	€ 30,60	500 x 120 mm	21,5 x 10,5 mm
M018/0600	€ 30,60	600 x 120 mm	21,5 x 10,5 mm
M018/0800	€ 35,60	800 x 120 mm	21,5 x 10,5 mm
M018/1000	€ 40,70	1000 x 120 mm	21,5 x 10,5 mm
M018/1200	€ 45,80	1200 x 120 mm	21,5 x 10,5 mm

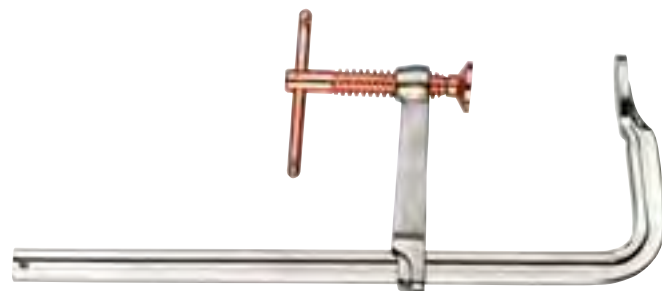

0167-

MORSETTO PER FALEGNAME



Art.	€	Apertura x Profondità
0167/150	€ 3,42	150 x 50 mm
0167/200	€ 6,40	200 x 80 mm
0167/250	€ 7,10	250 x 100 mm
0167/400	€ 9,70	400 x 100 mm
0167/500	€ 12,20	500 x 120 mm



0394-

MORSETTO RAPIDO AUTOMATICO



Art.	€	Apertura x Profondità	Stelo	Forza massima
0394/150	€ 7,60	150 x 63 mm	18 x 5,5 mm	60 kg
0394/300	€ 10,20	300 x 63 mm	18 x 5,5 mm	60 kg
0394/450	€ 11,80	450 x 63 mm	18 x 5,5 mm	60 kg
0394/600	€ 14,30	600 x 63 mm	18 x 5,5 mm	60 kg



0250

€ 43,80

MORSETTO 4 DIREZIONI

Fornito in kit di montaggio, per porte o tavoli in legno (listelli di legno non inclusi)



Spessore max	150 mm
--------------	--------



0353/085

€ 7,00

SERIE MORSETTI A MOLLA IN POLIPROPILENE

Con lunghezza di 85mm, utili in laboratorio per facilitare gli incollaggi e lavori simili.



Lunghezza	85 mm
Apertura	35 mm



0353/110

€ 7,50

SERIE MORSETTI A MOLLA IN POLIPROPILENE

Con lunghezza di 110mm, utili in laboratorio per facilitare gli incollaggi e lavori simili.



Lunghezza	110 mm
Apertura	40 mm



035x

MORSETTO A MOLLA

Utili in laboratorio per facilitare gli incollaggi e lavori simili.



Art.	€	Lunghezza	Apertura
0353/150	€ 3,29	150 mm	55 mm
0354/225	€ 4,52	225 mm	100 mm



0157-**INCUDINI IN ACCIAIO INDURITO**

Struttura robusta, foro rotondo e foro quadrato per punzonatura e piegatura.

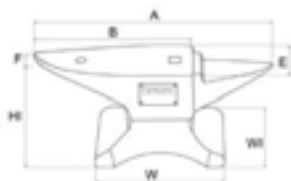

C50

Scatola



Art.	€	A	B	E	W	WI	HI	Tolleranza	Peso netto
0157/10	€ 112,00	345 mm	235 mm	80 mm	150 mm	110 mm	120 mm	±5%	10 kg
0157/30	€ 269,00	535 mm	360 mm	110 mm	215 mm	150 mm	160 mm	±5%	30 kg
0157/50	€ 392,00	620 mm	410 mm	140 mm	240 mm	175 mm	190 mm	±5%	50 kg
0157/100	€ 819,00	805 mm	520 mm	175 mm	315 mm	230 mm	240 mm	±5%	100 kg

0265/05**€ 35,00****INCUDINE IN GHISA**

Struttura robusta, foro rotondo e foro quadrato per punzonatura e piegatura



Scatola

Ghisa

A	230 mm
B	160 mm
E	57 mm
F	10,5 mm
W	112 mm
WI	85 mm
HI	95 mm
Tolleranza	±5%
Peso netto	5 kg







SABBIATRICI



0615



0605



0601



0687



0878



0575



0575S



0487



0580



0580S



0490



0462

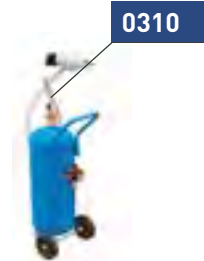

0310

Dimensioni interne (mm)

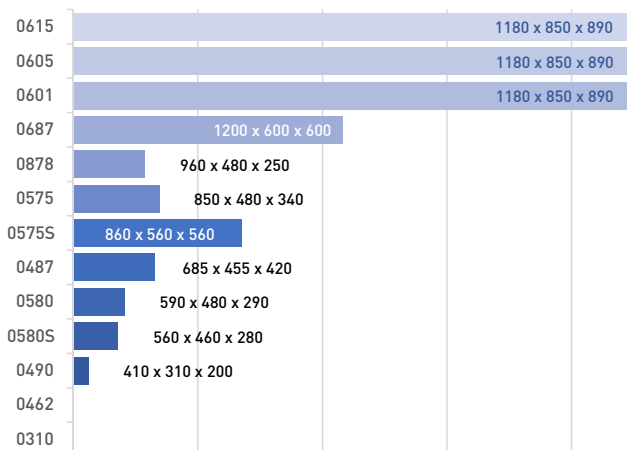

Consumo d'aria teorico (l/min)

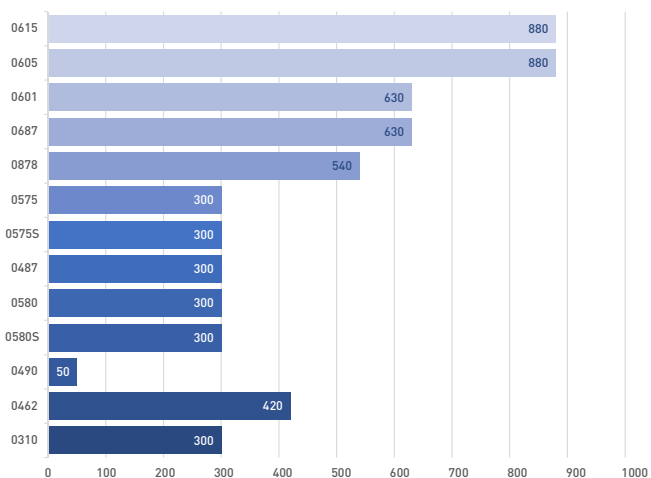

0615

€ 4310,00

SABBIATRICE A PRESSIONE

Con separatore polveri, filtro in HEPA, apertura frontale e plafoniera con 3 lampade fluorescenti.



Dimensioni interne	1180 x 850 x 890 h mm
Portata max	150 kg
Pressione di esercizio	6 ÷ 8 Bar
Consumo aria	31 SCFM 880 l / min
Ugelli pistola	Ø 6 - 7 mm

Aspiratore elettrico	230 V 50 Hz 0.7 kW
Capacità filtrante	8 micron
Dotata di illuminazione	Sì
Dimensioni ingombro	1330 x 1515 x 2070 h mm
Peso netto	300 kg

0605

€ 3810,00

SABBIATRICE A PRESSIONE CON 2 ASPIRATORI

Con serbatoio in pressione per aver un maggior effetto abrasivo, doppio aspiratore a ciclone, filtro in carta, apertura frontale e plafoniera con 3 lampade fluorescenti.



Dimensioni utili interne	1180 x 850 x 890 h mm
Portata max	150 kg
Pressione di esercizio	6 ÷ 8 Bar
Consumo aria	31 SCFM 880 l / min
Ugelli pistola	Ø 6 - 7 mm

Aspiratore elettrico	2 x 230 V 50 Hz 1.2 kW
Capacità filtrante	5 micron
Dotata di illuminazione	Sì
Dimensioni ingombro	1800 x 1515 x 2070 h mm
Peso netto	245 kg

0601

€ 3120,00

SABBIATRICE CON ASPIRATORE

A ciclone, filtro in carta, apertura frontale e plafoniera con 3 lampade fluorescenti.



Dimensioni utili interne	1180 x 850 x 890h mm
Portata max	150 kg
Pressione di esercizio	6 ÷ 8 Bar
Consumo aria	21 SCFM 630 l / min
Ugelli pistola	Ø 6 - 7 mm

Aspiratore elettrico	230 V 50 Hz 1.2 kW
Capacità filtrante	5 micron
Dotata di illuminazione	Sì
Dimensioni ingombro	1330 x 1240 x 1770 h mm
Peso netto	180 kg



0687

€ 2220,00

SABBIATRICE CON ASPIRATORE

Con filtro in carta



Dimensioni utili interne	1200 x 600 x 600 h mm
Portata max	120 kg
Pressione di esercizio	6.5 ÷ 7.5 Bar
Consumo aria	21 SCFM 630 l / min
Ugelli pistola	Ø 6 - 7 mm
Aspiratore elettrico	230 V 50 Hz 1.2 kW
Capacità filtrante	5 micron
Dimensioni ingombro	1220 x 910 x 1740 h mm
Peso netto	149 kg

0878

€ 1770,00

SABBIATRICE CON ASPIRATORE

Con filtro in carta

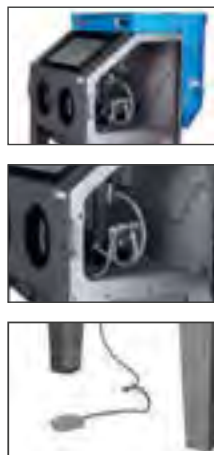

Dimensioni utili interne	960 x 480 x 250 ÷ 470 h mm
Pressione di esercizio	6.5 ÷ 7.5 bar
Consumo aria	18 SCFM 540 l / min
Ugelli pistola	Ø 4 - 5 - 6 - 7 mm
Aspiratore elettrico	230 V 50 Hz 1.2 kW
Capacità filtrante	5 micron
Dimensioni ingombro	1030 x 850 x 1640 h mm
Peso netto	100 kg

0575

€ 744,00

SABBIATRICE



Dimensioni utili interne	850 x 480 x 340 ÷ 540 h mm
Pressione di esercizio	6.5 ÷ 7.5 Bar
Consumo aria	8 ÷ 10 SCFM (240 ÷ 300 l / min)
Ugelli pistola	Ø 4 - 5 - 6 - 7 mm
Dimensioni ingombro	890 x 560 x 1385 h mm
Peso netto	46 kg

0575S

€ 690,00

SABBIATRICE

Fornita smontata.



Dimensioni utili interne	860 x 560 x 560 h mm
Pressione di esercizio	6.5 ÷ 7.5 bar
Consumo aria	8 ÷ 10 SCFM (240 ÷ 300 l / min)
Ugelli pistola	Ø 4 - 5 - 6 - 7 mm
Dimensioni ingombro	905 x 620 x 1390 h mm
Peso netto	44 kg

0487

€ 304,00

SABBIATRICE DA BANCO

Con predisposizione per il collegamento di un'aspirapolvere, illuminazione con lampada basso consumo, pistola e guanti



Dimensioni utili interne	685 x 455 x 420 h mm
Pressione di esercizio	6.5 ÷ 7.5 Bar
Consumo aria	8 ÷ 10 SCFM (240 ÷ 300 l / min)
Ugelli pistola	Ø 4 - 5 - 6 - 7 mm
Dotata di illuminazione	230 V 50 Hz; 6 W 12 V
Dimensioni ingombro	755 x 495 x 720 h mm
Peso netto	26.5 kg

0580

€ 288,00

SABBIATRICE DA BANCO



Dimensioni ingombro	630 x 510 x 490 h mm
Dimensioni utili interne	590 x 480 x 290 h mm
Pressione di esercizio	6.5 ÷ 7.5 Bar
Consumo aria	8 ÷ 10 SCFM (240 ÷ 300 l / min)
Ugelli pistola	Ø 4 - 5 - 6 - 7 mm
Peso netto	13 kg

0580S

€ 256,00

SABBIATRICE DA BANCO

Fornita smontata.



Dimensioni ingombro	585 x 485 x 495 h mm
Dimensioni utili interne	560 x 460 x 280 h mm
Pressione di esercizio	6.5 ÷ 7.5 Bar
Consumo aria	8 ÷ 10 SCFM (240 ÷ 300 l / min)
Ugelli pistola	Ø 4 - 5 - 6 - 7 mm
Peso netto	16 kg

0490

€ 434,00

MINI SABBIATRICE DA BANCO

Con comando a pedale e pistola fissa, per sabbiare parti piccole nel settore orafa, odontoiatrico e fai da te



Dimensioni utili interne	410 x 310 x 200 h mm
Pressione di esercizio	4 - 7.5 bar
Ugelli pistola	Ø 3.5 mm
Dotata di illuminazione	230 V 50 Hz, 6 W 12 V
Dimensioni ingombro	475 x 370 x 370 h mm
Peso netto	12 kg



0462 € 792,00

SABBIATRICE PER ESTERNO CON ASPIRATORE

Per oggetti metallici arrugginiti o da sverniciare che non possono essere inseriti in una sabbiatrice tradizionale, se l'oggetto da trattare è piano. l'aspiratore consente di non perdere la maggior parte di abrasivo che si sta usando. le quattro ruote permettono all'operatore di portare la macchina vicino all'oggetto da sabbicare

Lunghezza tubi	2.5 m
Motore	230 V 50 Hz 1.2 kW
Capacità di aspirazione	13 ÷ 15 kPa
Pressione di esercizio	8 Bar
Consumo aria	420 l / min
Dimensioni	404 x 612 x 1046 h mm
Peso netto	30 kg



0310 € 201,00

SABBIATRICE A BICARBONATO DI SODIO

Per uso esterno, leggera, facile da trasportare, indicata per la rimozione di vernici, ruggine, graffiti ecc...

Dimensioni ingombro	350 x 400 x 788 h mm
Capacità	18 l
Pressione di esercizio	2.5 ÷ 6.2 bar
Consumo aria	8 ÷ 10 SCFM (240 ÷ 300 l / min)
Ugelli pistola	Ø 2 - 3 mm
Peso netto	13 kg



SA01-CTRx

TAVOLA GIREVOLE PER SABBIATRICE

Con carrello.



Art.	€	Portata	Diametro	Dimensioni ingombro	Peso netto
SA01/CTR1	€ 514,00	150 kg	580 mm	920 x 580 x 1070h mm	43,5 kg
SA01/CTR2	€ 514,00	150 kg	580 mm	920 x 580 x 1335h mm	45 kg

SA01/TR € 113,00

TAVOLA GIREVOLE

Per sabbiatrici.



Diametro	380 mm
Dimensioni ingombro	380 x 43h mm
Peso netto	7 kg

SA01/C € 1130,00

CICLONE PER SABBIATRICI

A due stadi.



Capacità filtrante	8 micron
Portata d'aria	13500 l/min
Potenza massima	230 V 50 Hz 0,55 kW
Dimensioni ingombro	540 x 1000 x 1450h mm
Peso netto	55 kg

SA01/A € 355,00

ASPIRATORE PER SABBIATRICI

Cilindrico con filtro in carta, con batti filtro manuale e apertura nella parte inferiore.



Aspiratore elettrico	230 V 50 Hz 1,2 kW
Capacità filtrante	5 micron
Permeabilità all'aria	185 l/(m²s)
Diametro aspirazione	Ø 55 mm
Interasse fori	305 X 240 mm
Dimensioni	Ø 290 X 730 mm

0582-

CORINDONE

Si distingue per essere spigoloso ed estremamente stabile combinando le proprietà di durezza e densità. La sua longevità e riutilizzabilità lo rendono il materiale più usato per la sabbatura. Essendo composto per la maggior parte da ossido di alluminio è praticamente privo di ferro. Particolarmente indicato per la pulitura di superfici metalliche, rimozione di ruggine e strati di ossido e rimozione di colori di rinvenimento



Art.	€	Grana	Durezza	Peso netto
0582/36	€ 96,00	36	9 Mohs	25 kg
0582/80	€ 96,00	80	9 Mohs	25 kg

NEW

0578-

CARBURO DI SILICIO

Il Carbuuro di silicio nero è il materiale più duro utilizzato per la sabbatura, facendolo la soluzione ideale per tutti le lavorazioni più impegnative. Praticamente privo di ferro, le sue proprietà abrasive lo rendono molto aggressivo e veloce nella rimozione delle impurità. La sua conformazione permette ai grani di rompersi continuamente creando nuovi bordi affilati e taglienti, aumentando la finezza della granulometria. Molto duraturo e molto riutilizzabile. Tende ad incorporarsi nel materiale.



Art.	€	Grana	Durezza	Peso netto
0578/36	€ 132,00	36	9.1 Mohs	25 kg
0578/80	€ 132,00	80	9.1 Mohs	25 kg

0579-

NEW

GARNET

Il Garnet è uno degli ultimi abrasivi naturali ancora in utilizzo. È una pietra naturale, e quindi ecologica, con eccellenti proprietà abrasive che permette di creare profili privi di incorporazione dell'abrasivo, produrre poca polvere e avere un consumo relativamente basso. È eccellente per rimuovere rivestimenti duri, vernice, ruggine e scaglie di laminazione. Può essere usato sia per sabbatura a secco che ad acqua. Il suo basso costo lo rende un'alternativa al corindone.



Art.	€	Grana	Durezza	Peso netto
0579/30	€ 52,80	36 ÷ 60	7.5 Mohs	25 kg
0579/80	€ 52,80	80	7.5 Mohs	25 kg

NEW € 82,50

0569

SFERE DI ACCIAIO

Grazie alla loro superficie sferica e durezza permettono di ottenere superfici brillanti. Ottime per rimozione di vernici, imperfezioni, bave e ruggine. La loro bassa frantumazione non crea polvere all'interno della cabina di sabbatura e permette una lunga durata dell'abrasivo. Utilizzabili sia come mezzo per pallinatura che per sabbatura sia a secco che ad acqua.



Grana	S390
Durezza	40 ÷ 50 HRC
Peso netto	25 kg

0581

€ 84,80

MICROSFERE DI VETRO

Grazie alla loro forma sferica sono perfette per effettuare la finitura superficiale. Creano superfici lisce e luminose, lasciando un effetto satinato ineguagliabile. Non contenendo ferro sono molto indicate per lavorazioni su acciaio Inox ad utilizzo alimentare ed alluminio. Le microsfere non danneggeranno il substrato del materiale in lavorazione ma lasceranno un profilo di ancoraggio per una successiva verniciatura, soprattutto su materiali morbidi come ottone, alluminio, plastiche etc...



Grana	50 ÷ 70 (0,3 ÷ 0,2 mm)
Durezza	5-7 Mohs
Peso netto	25 kg

0310B

€ 74,00

BICARBONATO DI SODIO PER SABBARE

Composto salino a base di bicarbonato sintetico, adatto per trattare acciaio, alluminio, fibra di vetro, plastica, mattoni ecc...



Grana	36 ÷ 80 (0,5 ÷ 0,3 mm)
Durezza	2,5 - 3 Mohs
Temperatura di decomposizione	> 50°C
Peso netto	25 kg



0490/11 € 22,60

GUANTI PER SABBIAATRICE



Diametro guanti 100 mm

05x

COPPIA GUANTI

Morbidi e confortevoli



Art.	€	Lunghezza	Diametro guanti
0575/29	€ 39,90	600 mm	180 mm
0580/21	€ 39,90	450 mm	145 mm

0490/03 € 24,60

SERIE PROTEZIONI FINESTRA

Per sabbiatrici.



5 Pcs

0601/24 € 22,60

SERIE PROTEZIONI FINESTRA

Per sabbiatrici, 670 x 300mm.



5 Pcs

Misura 670 x 300 mm

0601/30 € 16,40

SERIE PROTEZIONI PLAFONIERA

Per sabbiatrici, 900 x 260 mm



5 Pcs

Misura 900 x 260 mm

0687/005 € 27,60

SERIE PROTEZIONI PLAFONIERA

Per sabbiatrici, 600 x 100 mm



10 Pcs

Misura 600 x 100 mm

0575/04 € 43,40

SERIE PROTEZIONI FINESTRA

Per sabbiatrici, 550 x 250 mm



10 Pcs

Misura 550 x 250 mm

0580/01-6 € 27,60

SERIE PROTEZIONI FINESTRA

Per sabbiatrici, 400 x 300 mm



5 Pcs

Misura 400 x 300 mm

SA01/F € 159,00

FILTRO PER CICLONE

In HEPA.



Diametro 320 mm
Altezza 600 mm

0687/029 € 74,50

FILTRO CICLONE



Diametro 170 mm
Altezza 305 mm

0687/041

€ 102,00

PISTOLA

Sabbiatrice



0290

€ 37,70

PISTOLA SABBIATRICE

Pistola in metallo, con ugelli in ceramica.



Ugelli in ceramica	Ø 4 - 5 - 6 - 7 mm
Lunghezza tubo in gomma	1,5 m
Attacco aria	G 1/4"
Livello pressione acustica	$\leq 70\text{ dB(A)}$
Vibrazioni	$\leq 2,5\text{ m/s}^2$
Pressione di esercizio	0.6 MPa

0577/17

€ 44,00

PISTOLA FISSA



U003

€ 105,00

UGELLO IN CARBURO DI BORO

Per sabbiatrici e pallinatrici, lunga durata



Diametro ugello

Ø 7,5 mm

U004

€ 66,80

UGELLO IN MATERIALE COMPOSITO

Per sabbiatrici e pallinatrici, lunga durata



0490/20

€ 9,20

SERIE UGELLI IN CERAMICA



4 Pcs

Diametro ugello

Ø 3,5 mm

Diametro ugello

6 mm

0462/55

€ 36,00

SERIE UGELLI IN CERAMICA



5 Pcs

Diametro ugello

Ø 7,5 mm

0575/0580/12

€ 17,30

SERIE UGELLI IN CERAMICA

4 pz, diametro Ø 4,5,6,7 mm



4 Pcs

Diametro ugello

Ø 4 - 5 - 6 - 7 mm

0687/102

€ 18,70

SERIE UGELLI IN CERAMICA



4 Pcs

Diametro ugello

Ø 6 - 7 mm



0305

€ 761,00

LAVAPEZZI AD ACQUA CALDA

Per lavaggi con acqua calda fino a 60° C, con pistola pneumatica ad effetto Venturi.



Capacità serbatoio	8 + 14 l
Consumo aria stimato	5 SCFM 145 l / min
Area di lavoro	760 x 560 x 380 mm
Pressione di lavaggio	5 ÷ 8 Bar
Potenza	1350 W
Dimensioni	790 x 610 x 1260 h mm
Peso netto	49 kg

0486

€ 545,00

VASCA DI LAVAGGIO DOPPIO USO



Dimensioni interne vasca sinistra	470 x 520 x 270 mm
Dimensioni interne vasca destra	590 x 520 x 270 mm
Capacità vasca	150 l
Pompa	230V 50Hz 26 + 26 W
Portata pompa	10 ÷ 12 l/min
Ingombro	1140 x 550 x 880 h mm
Peso netto	43 kg

0203

€ 582,00

LAVAPEZZI DA BANCO

Per lavaggi con acqua/solventi, con pistola pneumatica ad effetto Venturi



Dimensioni	770 x 595 x 700h mm
Capacità serbatoio	4 + 9 l
Consumo aria stimato	5 SCFM 145 l / min
Area di lavoro	765 x 560 x 380 mm
Potenza	30 W
Pressione di lavaggio	5 ÷ 8 Bar
Alimentazione	230 V 50 Hz
Peso netto	32 kg

0038

€ 283,00

VASCA DI LAVAGGIO

Capacità 75L, con pompa 26w, spazzola di pulizia e tubo flessibile, vassoio porta pezzi.



Dimensioni interne vasca	710 x 480 x 260h mm
Capacità vasca	75 l
Pompa	230 V 50 Hz 26 W
Portata pompa	10-12 l / min
Dimensioni	775 x 540 x 880 h mm
Peso netto	25 kg

0232 € 357,00

VASCA DI LAVAGGIO SU CARRELLO



Dimensioni interne vasca	710 x 480 x 200 h mm
Capacità vasca	60 l
Pompa	230 V 50 Hz 26 W
Portata pompa	10 ÷ 12 l / min
Dimensioni	970 x 540 x 930 h mm
Peso netto	35 kg

0632 € 805,00

VASCA DI LAVAGGIO PNEUMATICA



Dimensioni interne vasca	710 x 480 x 200 h mm
Altezza	1015 mm
Capacità serbatoio	50 l
Capacità vasca	65 l
Pressione di alimentazione	6 Bar
Pressione massima serbatoio	0.5 Bar
Peso netto	38 kg

0392 € 384,00

VASCA DI LAVAGGIO DA BANCO

Per montaggio a parete



Capacità	14 l
Luce al neon	24 V 8 W
Pompa	230 V 50 Hz 26 W
Portata pompa	10 ÷ 12 l / min
Dimensioni	560 x 545 x 635 h mm
Peso netto	25 kg

0211 € 508,00

BANCO MOBILE PER SMONTAGGI CON RECUPERO LIQUIDI

Fornito in kit di montaggio, con cassetto dotato di serratura, vasca estraibile e ruote pivotanti di cui due dotate di freno



Dimensioni	1200 x 640 x 872h mm
Dimensioni piano di lavoro	1190 x 635 x 15h mm
Dimensioni cassetto	420 x 340 x 120h mm
Dimensioni interne vasca	360 x 260 x 115h mm
Altezza mensola interna	445 mm
Portata massima con ruote	280 kg
Portata massima senza ruote	350 kg
Peso netto	64 kg

0233 € 261,00

VASCA DI LAVAGGIO PORTATILE

Costruita in ABS con guarnizioni in gomma NBR.



Dimensioni interne vasca	460 x 660 x 260 mm
Capacità	9 l
Pompa	230 V 50 Hz 16 W

0632-

LIQUIDO LAVAPEZZI



Art.	€	Contenuto	Specifica
0632/D	€ 143,00	25 l	A base solvente
0632/DA	€ 191,00	25 l	Diluibile con acqua max. 50%
0632/DCF	€ 105,00	25 l	Diluibile con acqua max. 20%, utilizzo a caldo



0632/01

€ 9,00

PENNELLO PER LAVAPEZZI

Non idoneo per prodotti a base di idrocarburi



Lunghezza	280 mm
Diametro	35 mm
Attacco	20mm x Ø10mm

0305/0203/1118

€ 35,00

COPPIA GUANTI PER LAVAPEZZI

Non idoneo per prodotti a base di idrocarburi



Lunghezza	540 mm
-----------	--------

A025/30

€ 104,00

ASPIRAPOLVERE ASPIRALIQUIDI 30L

Con serbatoio in acciaio inox, funzione soffiaggio, completo di accessori



Potenza	1,2 kW
Capienza	30 l
Motore	230 V 50 Hz
Portata d'aria	28 l / s
Peso netto	6 kg

A024/10

€ 69,90

ASPIRAPOLVERE ASPIRALIQUIDI 10L

Con serbatoio in ABS, funzione soffiaggio, completo di accessori.



Potenza	1,2 kW
Capienza	10 l
Motore	230 V 50 Hz
Portata d'aria	30 ± 2 l/s
Peso netto	3,7 kg

A040/30A

€ 182,00

ASPIRAPOLVERE ASPIRALIQUIDI 30L

Per uso industriale completo di accessori - dotato di presa per elettrotensili con accensione e spegnimento automatico



Potenza	1,4 kW
Capienza	30 l
Motori	1 (230 V 50 Hz)
Portata d'aria	35 l / s
Presa elettrotensile	1600 W
Peso netto	7,5 kg

A040/60A
€ 296,00
ASPIRAPOLVERE ASPIRALIQUIDI 60L

Per uso industriale completo di accessori - dotato di presa per elettrotensili con accensione e spegnimento automatico



Potenza	1,4 kW
Capienza	60 l
Motori	1 (230 V 50 Hz)
Portata d'aria	46 l/s
Presa elettrotensile	1600 W
Peso netto	13 kg

A040/802
€ 519,00
ASPIRAPOLVERE ASPIRALIQUIDI 80L 2 MOTORI

Per uso industriale completo di accessori



Potenza	2 kW
Capienza	80 l
Motori	2 (230 V 50 Hz)
Portata d'aria	75 l/s
Dimensioni	600 x 580 x 950 mm
Peso netto	25 kg

A024/602
€ 287,00
ASPIRAPOLVERE ASPIRALIQUIDI 60L CON 2 MOTORI

Con serbatoio in ABS, completo di accessori.



Potenza	2,8 kW
Capienza	60 l
Motori	2 (230 V 50 Hz)
Portata d'aria	30 ±2 l/s
Peso netto	12,5 kg

A040/803
€ 642,00
ASPIRAPOLVERE ASPIRALIQUIDI 80L 3 MOTORI

Per uso industriale completo di accessori



Potenza	3 kW
Capienza	80 l
Motori	3 (230 V 50 Hz)
Portata d'aria	96 l/s
Dimensioni	600 x 580 x 950 mm
Peso netto	28 kg



ACAS/001 € 10,20

SERIE DI FILTRI
IN SPUGNA PER
ASPIRAPOLVERE



ACAS/002 € 14,40

FILTRO HEPA PER
ASPIRAPOLVERE



ACAS/003 € 10,20

TUBO FLESSIBILE PER
ASPIRAPOLVERE



Ricambi Tubo da 1,5 m

ACAS/004 € 14,40

TUBO IN METALLO
ALLUNGABILE PER
ASPIRAPOLVERE



ACAS/005 € 10,20

COPPIA DI TUBI
IN PLASTICA PER
ASPIRAPOLVERE



ACAS/006 € 10,20

SERIE DI FILTRI
IN SPUGNA PER
ASPIRAPOLVERE



ACAS/007 € 10,20

FILTRO PER
ASPIRAPOLVERE



ACAS/008 € 22,60

SERIE DI SACCHETTI
IN CARTA PER
ASPIRAPOLVERE



ACAS/009 € 10,20

TUBO FLESSIBILE PER
ASPIRAPOLVERE



ACAS/010 € 10,20

SPAZZOLA GRANDE PER
ASPIRAPOLVERE



ACAS/011 € 6,20

SPAZZOLA MULTI
FUNZIONE PER
ASPIRAPOLVERE



ACAS/012 € 21,20

SERIE DI SACCHETTI
IN CARTA PER
ASPIRAPOLVERE



ACAS/013 € 20,60

SERIE SACCHETTI
In carta per aspirapolvere.



ACAS/014 € 10,20

TUBO IN PLASTICA
Per aspirapolvere



ACAS/015 € 9,20

SPAZZOLA PICCOLA
Per aspiratore.



ACAS/017 € 10,20

SERIE FILTRI IN SPUGNA
Per aspiratore.



A040/8037 € 18,50

TUBO FLESSIBILE PER
ASPIRAPOLVERE



A040/8040 € 26,70

COPPIA TUBI IN METALLO
PER ASPIRAPOLVERE



Lettera F
Ricambi Coppia tubi in metallo

A040/8047U € 14,40

SPAZZOLA DA UMIDO
PER ASPIRAPOLVERE



A040/8047S € 13,30

SPAZZOLA DA SECCO PER
ASPIRAPOLVERE



A040/8029 € 15,40

FILTRO PER
ASPIRAPOLVERE



A040/8046 € 5,10

LANCIA CORTA PER
ASPIRAPOLVERE



A040/8048 € 8,30

SPAZZOLA ROTONDA PER
ASPIRAPOLVERE



Lettera D
Ricambi Lancia corta

M041 **FERVIplus**

PRO € 7290,00

MACCHINA MARCATRICE A MICROPUNTI PORTATILE

Completa di computer con touch screen



Area di marcatura	110 x 40 mm
Velocità di scrittura	3 - 5 Caratteri / sec
Massima durezza del pezzo	≤HRC62
Peso netto	65 kg

M040 **FERVIplus**

PRO € 6050,00

MACCHINA MARCATRICE A MICROPUNTI, PNEUMATICA

Con connessione usb, software per windows xp e windows 7 32 bit



Area di marcatura	110 x 80 mm
Velocità di scrittura	30 - 40 mm / sec
Dimensioni tavola	320 x 300 mm
Massima durezza del pezzo	≤HRC62
Peso netto	60 kg

M040/CF € 133,00

COMANDO A FILO PER MARCATRICE



M040/CP € 287,00

COMANDO A PEDALE PER MARCATRICE



M040/D € 1930,00

DIVISORE PER MARCATRICE



M040/SA € 154,00

SUPPORTO PER ALBERI PER MARCATRICE



M040/SP € 352,00

SUPPORTO PER TARGHETTE PER MARCATRICE



M040/ST € 133,00

SUPPORTO PER TUBI PER MARCATRICE





P012-L

LETTERE HRC 58-60



Art.	€	Dimensioni carattere	Dimensioni gambo
P012/L03	€ 17,30	3 mm	6 x 6 x 60h mm
P012/L04	€ 18,00	4 mm	7 x 7 x 61h mm
P012/L05	€ 20,20	5 mm	7,5 x 7,5 x 61h mm
P012/L06	€ 22,60	6 mm	8,8 x 8,8 x 63h mm
P012/L08	€ 29,50	8 mm	10 x 10 x 66h mm

P012-N

NUMERI HRC 58-60



Art.	€	Dimensioni carattere	Dimensioni gambo
P012/N03	€ 9,50	3 mm	6 x 6 x 60h mm
P012/N04	€ 10,60	4 mm	7 x 7 x 61h mm
P012/N05	€ 11,50	5 mm	7,5 x 7,5 x 61h mm
P012/N06	€ 12,70	6 mm	8,8 x 8,8 x 63h mm
P012/N08	€ 13,90	8 mm	10 x 10 x 66h mm

P021

€ 25,40

PENNA ELETTRICA A BATTERIA

Rotativa, con 2 punte diamantate Ø 2,35mm, maneggevole e leggera, adatta all'incisione di vetro, ceramica, plastica, legno, inox, ottone, alluminio, acciai teneri.



Velocità	20000 rpm
Lunghezza	160 mm
Batterie non incluse	2 x 1,5 V AAA

P012-LxP

LETTERE HRC 58-60

Micro stress



Art.	€	Dimensioni carattere	Dimensioni gambo
P012/L03P	€ 37,70	3 mm	7 x 7 x 61h mm
P012/L04P	€ 41,00	4 mm	7,5 x 7,5 x 61h mm
P012/L05P	€ 45,60	5 mm	8,8 x 8,8 x 63h mm
P012/L06P	€ 53,40	6 mm	10 x 10 x 66h mm
P012/L08P	€ 90,30	8 mm	12 x 12 x 70h mm

P012-NxP

NUMERI HRC 58-60

Micro stress



Art.	€	Dimensioni carattere	Dimensioni gambo
P012/N03P	€ 17,30	3 mm	7 x 7 x 61h mm
P012/N04P	€ 20,70	4 mm	7,5 x 7,5 x 61h mm
P012/N05P	€ 25,90	5 mm	8,8 x 8,8 x 63h mm
P012/N06P	€ 29,70	6 mm	10 x 10 x 66h mm
P012/N08P	€ 35,50	8 mm	12 x 12 x 70h mm

P002

€ 4,10

PUNTE PER TRACCIARE CON CUSPIDE IN METALLO DURO



Lunghezza	153 mm
-----------	--------

P005

€ 4,69

PUNTA PER TRACCIARE IN ACCIAIO



Lunghezza	270 mm
-----------	--------

P039

€ 7,20

PUNTE PER TRACCIARE

Con cuspidi in metallo duro.



Punta a scomparsa

Lunghezza

150 mm

P039/PR

€ 5,10

SET PUNTE DI RICAMBIO IN METALLO DURO



2 Pcs



Lunghezza

40 mm

P020

€ 28,50

PENNA ELETTRICA A VIBRAZIONE

Con regolazione della vibrazione, adatta all'incisione di vetro, ceramica, plastica, legno, inox, ottone, alluminio, acciai teneri



Vibrazioni

7200 / min

Alimentazione

230 V 50 Hz 13 W

P020/P

€ 7,90

SERIE PUNTE DI RICAMBIO



2 Pcs





PRESSE



Portata (Ton)

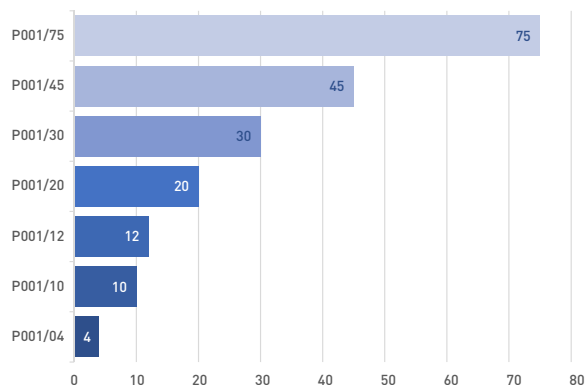

Corsa del pistone (mm)

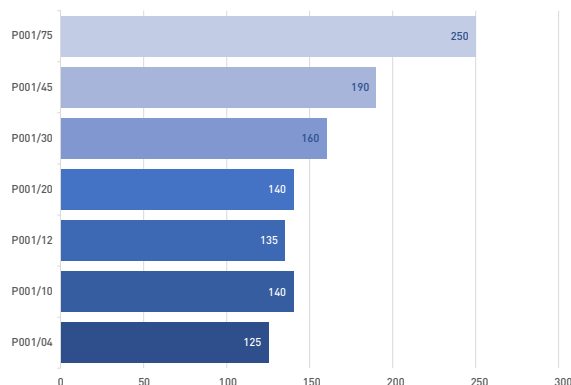

Area di lavoro

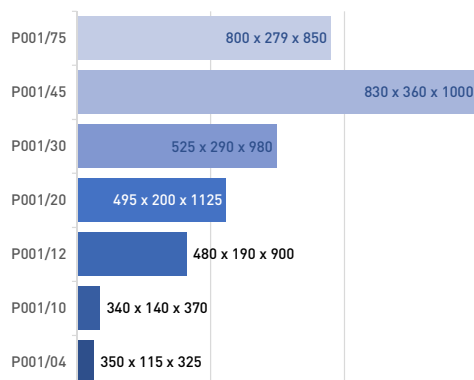

P001/75
€ 5480,00
PRESSA IDRAULICA MANUALE E PNEUMATICA

Dotata di pistone mobile carrellato, con argano per movimentazione banco, comando manuale a due velocità e servopompa pneumatica con comando a pedale.



Portata	75000 kg
Area di lavoro	800 x 279 x 850 h mm
Ø pistone	125 mm
Diametro pistone	78 mm
Corsa pistone	250 mm
Pressione di esercizio	0,75 + 0,85 MPa
Dimensioni	1140 x 800 x 1896 h mm
Peso netto	460 kg

P001/45
€ 2860,00
PRESSA IDRAULICA MANUALE E PNEUMATICA

Dotata di pistone mobile carrellato, con argano per movimentazione banco, comando manuale e servopompa pneumatica con comando a mano



Portata	45000 kg
Area di lavoro	830 x 360 x 1000 h mm
Ø cilindro	90 mm
Ø pistone	58 mm
Corsa pistone	190 mm
Pressione di esercizio	7+ 8 Bar
Pressione massima	63,5 MPa
Dimensioni	1400 x 800 x 1700 h mm
Peso netto	330 kg

P001/30
€ 1130,00
PRESSA MANUALE IDRAULICA

Con pompa a due velocità e pistone mobile



Portata	30000 kg
Area di lavoro	525 x 290 x 980 h mm
Ø cilindro	92 mm
Ø pistone	56 mm
Corsa pistone	160 mm
Pressione massima	69 MPa
Dimensioni	875 x 700 x 1780 h mm
Peso netto	145 kg





P001/20

€ 924,00

PRESSA MANUALE IDRAULICA

Con pistone mobile



Portata	20000 kg
Area di lavoro	495 x 200 x 1125 h mm
Ø cilindro	75 mm
Ø pistone	48 mm
Corsa pistone	140 mm
Pressione massima	69.3 MPa
Dimensioni	690 x 600 x 1830 h mm
Peso netto	94 kg



P001/12

€ 559,00

PRESSA MANUALE IDRAULICA

Con pistone mobile



Portata	12000 kg
Area di lavoro	480 x 190 x 900 h mm
Ø cilindro	56 mm
Ø pistone	38 mm
Corsa pistone	135 mm
Pressione massima	69 MPa
Dimensioni	730 x 550 x 1600 h mm
Peso netto	60 kg



P001/10

€ 457,00

PRESSA MANUALE IDRAULICA

Da banco con pistone mobile



Portata	10000 kg
Area di lavoro	340 x 140 x 370 h mm
Ø cilindro	56 mm
Ø pistone	38 mm
Corsa pistone	140 mm
Pressione massima	69 MPa
Dimensioni	565 x 500 x 1040 h mm
Peso netto	52 kg



P001/04

€ 305,00

PRESSA MANUALE IDRAULICA

Da banco, 4 ton, per cuscinetti



Portata	4000 kg
Area di lavoro	350 x 115 x 325 h mm
Ø cilindro	40 mm
Ø pistone	25 mm
Corsa pistone	125 mm
Pressione massima	51 MPa
Dimensioni	450 x 400 x 655 h mm
Peso netto	30 kg



P022-

PRESSA MANUALE A CREMAGLIERA

Con tavola girevole estraibile



P022/05



P022/10



P022/20

Art.	€	Forza	Altezza max pezzo	Max Ø pezzo	Sezione albero	Peso netto
P022/05	€ 92,40	5000 N	90 mm	160 mm	19 x 19 mm	8 kg
P022/10	€ 130,00	10000 N	100 mm	180 mm	25 x 25 mm	12 kg
P022/20	€ 304,00	20000 N	170 mm	260 mm	30 x 30 mm	27 kg

P029-

PRESSA MANUALE A CREMAGLIERA

Con tavola girevole estraibile



Art.	€	Forza	Dimensioni	Altezza max pezzo	Max Ø pezzo	Sezione albero	Peso netto
P029/2	€ 347,00	15000 N	400 x 175 x 450h mm	210 mm	300 mm	31,5 x 31,5mm	42 kg
P029/3	€ 439,00	25000 N	450 x 200 x 570h mm	310 mm	300 mm	37,8 x 37,8mm	60 kg

P028-

PRESSA MANUALE

Con molla di ritorno



Art.	€	Forza	Dimensioni	Altezza max pezzo	Max Ø pezzo	Corsa albero	Peso netto
P028/07	€ 137,00	1500 N	240 x 155 x 335h mm	170 mm	150 mm	60 mm	8,5 kg
P028/14	€ 232,00	2000 N	280 x 170 x 760h mm	275 mm	180 mm	70 mm	18 kg

0485

€ 100,00

SERIE DI PUNZONI PER PRESSE

Da 20t e 30t.



8 Pcs

Dimensione testa dei perni

24,7 mm



0054/10

€ 385,00

UNITÀ IDRAULICA IN KIT



Capacità	10 ton
Lunghezza pistone	330 mm
Corsa pistone	130 mm
Peso netto	30 kg

0054/4

€ 310,00

UNITÀ IDRAULICA IN KIT



Capacità	4 ton
Lunghezza pistone	270 mm
Corsa pistone	120 mm
Peso netto	19 kg

0664

€ 349,00

POMPA IDRAULICA CON COMANDO PNEUMATICO A PEDALE

Adatta per presse, cric e pistoni



Pressione nominale	70 MPa
Pressione di esercizio	7 ÷ 8 bar
Capacità olio	690 c.c.
Consumo aria	10 SCFM
Peso netto	8 kg

0271

€ 142,00

POMPA IDRAULICA

Con pedale di azionamento pompa.



Pressione nominale	63,7 MPa
Capacità olio	790 ml
Lunghezza tubo	1500mm
Peso netto	7 kg

0663

€ 127,00

TIRANTE IDRAULICO



Portata	5 ton
Lunghezza Chiuso	560 mm
Lunghezza Aperto	690 mm
Stelo	Ø 33 mm
Corsa	130 mm
Peso netto	5,5 kg

0567

€ 103,00

CRIC A PROFILO RIBASSATO

Da 2 ton, costruito in acciaio, con maniglie di sollevamento



Capacità	2 ton
Alzata	90 ÷ 385 mm
Dimensioni	580 x 165 x 235 h mm
Peso netto	13 kg

0457

€ 576,00

CRIC A PROFILO RIBASSATO

Da 2 ton, costruito in acciaio, con impugnatura circolare.



Capacità	2 ton
Alzata	70 ÷ 500 mm
Dimensioni	785 x 350 x 152 mm
Peso netto	41 kg

0369

€ 358,00

CRIC A PROFILO RIBASSATO

A doppio pompante con sella smontabile e tampone in gomma



Capacità	3,5 ton
Dimensioni	745 x 335 x 180 mm
Alzata	110 ÷ 560 mm
Peso netto	46 kg

0375A

€ 295,00

CRIC A PROFILO RIBASSATO

Da 2.5 ton, avvicinamento veloce con doppia pompa, con limitatore di carico.



Capacità	2.5 ton
Alzata	75 ÷ 500 mm
Dimensioni	680 x 345 x 220 h mm
Peso netto	32,5 kg

0065A

NEW € 249,00

CRIC A CARRELLO

Con sella smontabile.



Capacità	3 ton
Dimensioni	660 x 345 x 260 mm
Alzata	140 ÷ 515 mm
Peso netto	33 kg

C038/30

€ 185,00

CRIC A CARRELLO



Capacità	3 ton
Dimensioni	572 x 328 x 175h mm
Alzata	130 ÷ 465 mm
Peso netto	28 kg





0060

€ 76,10

CRIC A CARRELLO

Telaio in acciaio. Maniglia per il trasporto a mano. Leva allungabile.



Portata	2 ton
Dimensioni	535 x 225 x 145 mm
Alzata	135 ÷ 385 mm
Peso netto	11 kg

C039/25

€ 315,00

CRIC A CARRELLO

Cric a carrello in alluminio e acciaio a doppio pompante, avvicinamento rapido



Capacità	2,5 ton
Dimensioni	659 x 289 x 165 h mm
Alzata	110 ÷ 460 mm
Peso netto	27 kg

C039/15

€ 228,00

CRIC A CARRELLO

Cric a carrello in alluminio e acciaio a doppio pompante, avvicinamento rapido



Capacità	1,5 ton
Dimensioni	490 x 270 x 130 h mm
Alzata	90 ÷ 358 mm
Peso netto	15 kg

0658

€ 858,00

SOLLEVATORE IDRAULICO



Capacità	10 ton
Sollevamento sul piede	30 ÷ 260 mm
Sollevamento sulla testa	420 ÷ 665 mm
Peso netto	30 kg

0067

€ 29,20

COPPIA DI CAVALLETTI

Altezza regolabile con perno di fissaggio.



Portata	2 ton
Altezze	240 - 270 - 320 - 365 mm
Peso netto	3 kg

0069-

COPPIA DI CAVALLETTI



Art.	€	Portata	Altezza min - max	Dimensioni base	Peso netto
0069/3	€ 48,20	3 ton	298 ÷ 428 mm	190 x 210 mm	6,5 kg
0069/6	€ 89,60	6 ton	400 ÷ 610 mm	260 x 285 mm	13 kg
0069/10	€ 197,00	10 ton	468 ÷ 718 mm	290 x 328 mm	29 kg

0021/1
NEW € 554,00
GRUETTA IDRAULICA PIEGHEVOLE

Con due ruote pivotanti dotate di freno, ruote in fusione di ghisa. Sistema di discesa e leva di pompaggio laterali. La possibilità di piegare le gambe quando non in utilizzo permette di immagazzinarla in spazi ristretti.



Portata	1000 kg
Dimensioni	1540 x 1020 x 1550h mm
Dimensioni chiusa	490 x 510 x 1520h mm
Sbraccio min/max	810 ÷ 1090 mm
Altezza gancio con braccio alzato	1900 mm @ 1000 kg 2080 mm @ 250 kg
Altezza gancio con braccio abbassato	0 mm @ 250 kg 240 mm @ 1000 kg
Apertura anteriore	1030 mm
Peso netto	64,5 kg

0021/2
NEW € 678,00
GRUETTA IDRAULICA PIEGHEVOLE

Con due ruote pivotanti dotate di freno, ruote in fusione di ghisa. Sistema di discesa e leva di pompaggio laterali. La possibilità di piegare le gambe quando non in utilizzo permette di immagazzinarla in spazi ristretti.



Portata	2000 kg
Dimensioni	1760 x 1031 x 1600h mm
Dimensioni chiusa	855 x 720 x 1610h mm
Sbraccio min/max	750÷ 1280 mm
Altezza gancio con braccio alzato	1980 mm @ 2000 kg 2450 mm @ 500 kg
Altezza gancio con braccio abbassato	0 mm @ 500 kg 300 mm @ 2000 kg
Apertura anteriore	1050 mm
Peso netto	90,5 kg

0063
€ 695,00
GRUETTA IDRAULICA PIEGHEVOLE

Con due ruote pivotanti e freno posteriore a tampone, sistema di discesa e leva di pompaggio posteriore, ruote in fusione di ghisa. La possibilità di piegare le gambe quando non in utilizzo permette di immagazzinarla in spazi ristretti.



Portata	1000 kg
Dimensioni	1800 x 1000 x 1500h mm
Dimensioni chiusa	800 x 860 x 1600h mm
Sbraccio min/max	680 ÷ 1220 mm
Altezza gancio con braccio alzato	2100 mm @ 1000 kg 2550 mm @ 250 kg
Altezza gancio con braccio abbassato	0 mm @ 250 kg 480 mm @ 1000 kg
Apertura anteriore	800 mm
Peso netto	90 kg

0094
€ 348,00
SOLLEVATORE IDRAULICO PER FOSSA E SOTTOPONTE

Con limitatore di carico, supporto a croce e supporto inclinabile per allineare e posizionare meglio cambi e differenziali.



Portata	500 kg
Dimensioni	1190 x 700 x 660 mm
Altezza di sollevamento	1190 ÷ 2000 mm
Peso netto	32,5 kg



S033 **NEW** € 164,00

SUPPORTO MOTORE

2 ruote girevoli con freno e 2 ruote fisse in ghisa, possibilità di inclinare il motore. Dotato di piano porta minuteria girevole



Portata	600 kg
Dimensioni	1230 x 850 x 930 mm
Peso netto	27,5 kg

S019 € 149,00

SUPPORTO MOTORE

2 ruote girevoli con freno e 2 ruote fisse, possibilità di inclinare il motore



Portata	450 kg
Dimensioni	865 x 810 x 870 mm
Peso netto	21 kg

0147 € 59,70

LIVELLATORE DI CARICO

Per gruette o carro ponte, per bilanciare e sollevare pesi leggermente sbilanciati.



Capacità	680 kg
Larghezza	440 mm
Max spostamento della slitta	330 mm
Catena	350 mm
Peso netto	5 kg

S068 **NEW** € 209,00

SUPPORTO MOTORE

2 ruote girevoli con freno e 2 ruote fisse in ghisa, possibilità di inclinare il motore. La possibilità di piegarlo quando non in utilizzo permette di immagazzinarla in spazi ristretti.



Portata	680 kg
Dimensioni	860 x 830 x 870 mm
Peso netto	31 kg

S024 € 143,00

STAFFE DI SOLLEVAMENTO MOTORE

Staffe a ponte per sostenere il motore nel vano dell'auto, viene usato quando si smonta il cambio o il differenziale. pratiche protezioni in gomma morbida di appoggio nelle canaline dei parafranghi, regolazioni precise e immediate per sostenere il motore all'interno dei parafranghi. staffe girevoli e inclinabili.



Capacità	500 kg
Regolazione	205 mm
Lunghezza utile	730 ÷ 1480 mm
Peso netto	13 kg

R015 € 168,00

SET RAMPE PER AUTO

Set composto da due solide rampe per facilitare il lavoro sotto i veicoli. Queste piccole rampe sono adatte ai modelli più comuni di utilitarie e SUV o anche ai veicoli più lunghi. Prodotti in polipropilene, i cunei sono decisamente più affidabili rispetto alle rampe in acciaio. Inoltre, grazie alla loro struttura antiscivolo, offrono un'ottima stabilità. Leggere e ben sagomate, le rampe sono facili da trasportare e salvarspazio.



Dimensioni	905 x 330 x 218 mm
Capacità	2,5 ton
Larghezza max pneumatico	240 mm
Altezza di sollevamento	170 mm
Inclinazione	15°
Peso netto	8 kg

0649-

RAMPE IN ALLUMINIO

In alluminio con pavimenti antisdrucciolo. Portata 170kg



Art.	€	Dimensioni	Portata	Pendenza max	Dislivello max	Peso netto
0649/1500	€ 380,00	1520 x 735 mm	170 kg	12,5 % (7°)	180 mm	13,5 kg
0649/1800	€ 472,00	1800 x 735 mm	150 kg	12,5 % (7°)	220 mm	16 kg

0598

€ 20,60

FERMA RUOTE DA GARAGE

In polipropilene



Dimensioni 685 x 305 x 38 mm

0592

€ 7,60

PARACOLPI DA GARAGE

In polipropilene



Dimensioni 640 x 165 x 15 mm

0594

€ 147,00

CARRELLINO RACCOGLI OLIO SENZA SERBATOIO

Per uso sotto ponte



Dimensioni base	390 x 390 mm
Altezza massima	1700 mm
Peso netto	13 kg

0595

€ 295,00

UNITÀ RACCOGLI OLIO

Carrellata con serbatoio per uso sotto ponte



Capacità serbatoio	70 l
Altezza min - max	1170 ÷ 1860 mm
Pressione massima serbatoio	0.45 bar
Peso netto	23 kg

0596

€ 473,00

UNITÀ ASPIRA OLIO PNEUMATICA

Carrellata, per olio esausto, con sonde di aspirazione di vario diametro, anche per uso sotto ponte



Capacità serbatoio	70 l
Capacità serbatoio graduato	10 l
Altezza massima	1500 mm
Sonda in metallo	2 x Ø6 mm x 695 mm
Sonda in nylon	2 x Ø6 mm x 680 mm 2 x Ø8 mm x 700 mm
Aspirazione	Ø6 x 4,5 mm - 0,4 ÷ 0,8 U/min Ø8 x 6,5 mm - 1 ÷ 1,6 U/min
Lunghezza tubo in gomma	Aspirazione 1500 mm Scarico 2050 mm
Pressione di alimentazione	8 ÷ 10 bar
Pressione massima serbatoio	0.45 bar
Peso netto	25 kg

**0630/2720****€ 1050,00****ARGANO ELETTRICO A 12V IN CORRENTE CONTINUA**

Motore a magneti permanenti, telaio in metallo, cavo resistente, con dispositivo anti avvolgimento del cavo e guida cavo. Da utilizzare esclusivamente per il tiro orizzontale, non adatto al sollevamento.



Tiro nominale orizzontale	2720 kg
Velocità	1,3 - 4,5 m / min
Motore	12 V 1,3 kW 1,8 hp
Riduzione	294:1
Dimensioni cavo	Ø 7,2 mm x 32 m
Dimensioni tamburo	Ø 63 x 228 mm
Dimensioni ingombro	520 x 180 x 175h mm
Peso netto	29 kg

0630/2200**€ 776,00****ARGANO ELETTRICO A 12V IN CORRENTE CONTINUA**

Motore a magneti permanenti, telaio in metallo, cavo resistente, con dispositivo anti avvolgimento del cavo e guida cavo. Da utilizzare esclusivamente per il tiro orizzontale, non adatto al sollevamento.



Tiro nominale orizzontale	2000 kg
Velocità	1,5 - 3,6 m / min
Motore	12 V 1,0 kW 1,3 hp
Rapporto riduzione ingranaggi	172:1
Dimensioni cavo	Ø 6,4 mm x 14,5 m
Dimensioni tamburo	Ø 45 x 97 mm
Dimensioni ingombro	364 x 126 x 141h mm
Peso netto	13 kg

0630/0900**€ 314,00****ARGANO ELETTRICO A 12V IN CORRENTE CONTINUA**

Motore a magneti permanenti, telaio in metallo, gancio con puleggia per tiro doppio, cavo resistente, con dispositivo anti avvolgimento del cavo e guida cavo. Da utilizzare esclusivamente per il tiro orizzontale, non adatto al sollevamento.



Tiro nominale orizzontale	450 / 900 kg
Velocità	1,3 - 3,2 m / min
Motore	12 V 0,7 kW 0,9 hp
Rapporto riduzione ingranaggi	153:1
Dimensioni cavo	Ø 4 mm x 15 m
Dimensioni tamburo	Ø 31,5 x 73 mm
Dimensioni ingombro	285 x 105 x 105h mm
Peso netto	6,7 kg

0447 € 66,20

CARICA BATTERIE DIGITALE INTELLIGENTE DA 12V/2A

Ricarica batterie al piombo, AMG, AL, GEL, WET, VRLA, MF. Microprocessore per carica automatica a 3 stadi. Modalità ricarica 14.4V - 2A. Commutazione automatica.

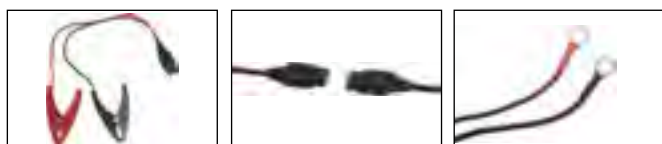

Alimentazione	220 ÷ 240 V, 50 ÷ 60 Hz
Potenza	14,4 V 4 A max
Batteria	12 V
Tempo di utilizzo	Da -20°C a +50°C

0478 € 135,00

CARICA BATTERIE DIGITALE INTELLIGENTE DA 12V/8A

Adatto per caricare tutti i tipi di batterie 12V al piombo, incluse wet, gel e agm. Carica le batterie anche a temperature fredde. Gestione automatica del ciclo di carica a 9 stadi. Questo carica batteria ricarica le batterie fino al 100% della loro capacità iniziale. Può in certi casi automaticamente recuperare batterie leggermente solfatate.

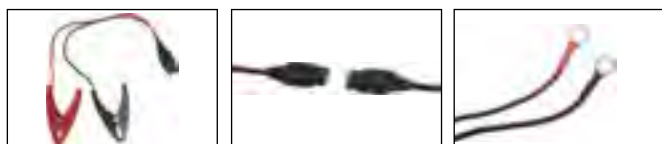

Alimentazione	230 V, 50 ÷ 60 Hz
Potenza	14,4 V, 8 A
Modalità operativa moto	14,4 V 2 A
Modalità operativa auto	14,4 V 8 A
Modalità operativa inverno	14,7 V 8 A
Modalità operativa alimentazione	13,5 V 5 A
Temperatura di esercizio	da -20°C a +50°C
Dimensioni	181 x 77 x 281 mm
Batteria	12 V

0432 € 96,80

CARICA BATTERIE DIGITALE INTELLIGENTE DA 6-12V/4A

Ricarica batterie al piombo, AMG, AL, GEL, WET, VRLA, MF. Microprocessore per carica automatica a 9 stadi. Modalità ricarica 14.7V - 2A. Commutazione automatica.



Alimentazione	230 V 50 ÷ 60 Hz
Potenza	14,7 V 4 A max
Modalità operativa moto	14,4 V 1 A
Modalità operativa auto	14,4 V 4 A
Modalità operativa inverno	14,7 V 4 A
Modalità operativa carica batterie	6 V : 7,2 V 4 A
Temperatura di esercizio	-20°C a +50°C
Dimensioni	145 x 56 x 230 mm
Batteria	12 V, 6 V

0479 € 149,00

CARICA BATTERIE DIGITALE INTELLIGENTE DA 12V/2-6-12A

Con presa per apparecchi a 12V 12A in corrente continua



Alimentazione	230V 50Hz
Potenza	12 V 2 - 6 - 12 A
Dimensioni	218 x 165 x 238 mm
Temperatura di esercizio	da -20°C a +50°C



S029 € 2630,00

SOLLEVATORE PER MOTO ELETTRIDRAULICO



Capacità di sollevamento	600 kg
Dimensioni piattaforma	2200 x 750 mm
Lunghezza totale	2995 mm
Dimensione botola	550 x 340 mm
Altezza di sollevamento	260 - 520 - 625 - 710 - 780 - 840 mm
Morsa	330 x 320 mm
Apertura morsa	40 ÷ 180 mm
Motore	230 V 50 Hz 550 W
Peso netto	225 kg

S029P € 2850,00

SOLLEVATORE PER MOTO ELETTRIDRAULICO

Con pompa e sistema di comando separato che danno la possibilità di posizionarlo a filo pavimento.



Capacità di sollevamento	600 kg
Dimensioni piattaforma	2200 x 750 mm
Lunghezza totale	2995 mm
Dimensione botola	550 x 340 mm
Altezza di sollevamento	215 - 520 - 625 - 710 - 780 - 840 mm
Morsa	330 x 320 mm
Apertura morsa	40 ÷ 180 mm
Motore	230 V 50 Hz 550 W
Peso netto	240 kg

S027 € 2400,00

SOLLEVATORE PER MOTO ELETTRIDRAULICO



Capacità di sollevamento	600 kg
Dimensioni piattaforma	1800 x 600 mm
Lunghezza totale	2600 mm
Dimensione botola	550 x 340 mm
Altezza di sollevamento	260 ÷ 880 mm
Morsa	330 x 320 mm
Apertura morsa	40 ÷ 200 mm
Motore	230 V 50 Hz 550 W
Peso netto	150 kg

S027ATV € 3190,00

SOLLEVATORE PER MOTO E QUAD ELETTRIDRAULICO



Capacità di sollevamento	600 kg
Dimensioni piattaforma	1800 x 1200 mm
Lunghezza totale	2600 mm
Dimensione botola	550 x 340 mm
Altezza di sollevamento	260 ÷ 880 mm
Morsa	330 x 320 mm
Apertura morsa	40 ÷ 200 mm
Motore	230 V 50 Hz 550 W
Peso netto	235 kg

S008/M € 969,00

SOLLEVATORE IDRAULICO

Per moto con pompa a pedale



Capacità di sollevamento	400 kg
Dimensioni piattaforma	1825 x 660 mm
Lunghezza totale	2500 mm
Altezza di sollevamento	195 ÷ 750 mm
Morsa	270 x 100 mm
Apertura morsa	210 x 50 mm
Peso netto	133 kg

0452 € 159,00

SOLLEVATORE A PANTOGRAFO PER MOTO

Da usare su ponte o a terra per riparare o fare manutenzione alla moto, con 2 supporti scorrevoli regolabili in altezza e removibili



Capacità di sollevamento	400 kg
Dimensioni piattaforma	470 x 150 mm
Altezza di sollevamento	95 ÷ 400
Altezza supporto	55 - 80 mm
Esagono	22 mm
Peso netto	14 kg

0241 € 103,00

CAVALLETTO ANTERIORE PER MOTO

Struttura solida, comoda e di semplice utilizzo, regolazione dimensione ruota, bloccaggio di sicurezza



Dimensioni ruota	15" - 21"
Dimensioni ingombro	730 x 468 x 440h mm
Peso netto	10 kg

S013 € 1900,00

SOLLEVATORE IDRAULICO

Per moto e quad con pompa a pedale e pneumatica



Capacità di sollevamento	600 kg
Dimensioni piattaforma	2000 x 1220 mm
Lunghezza totale	2575 mm
Altezza di sollevamento	185 ÷ 825 mm
Peso netto	230 kg

0430 € 266,00

CARRELLO SPOSTA MOTO

In acciaio, verniciato a polvere, idoneo per le moto e gli scooter con cavalletto laterale.



Portata max	300 kg
Lunghezza	1929 mm
Peso netto	33 kg

0217 € 206,00

SOLLEVATORE POSIZIONATORE PER AUTO

Con freni di bloccaggio posizionario



Capacità	680 kg
Corsa laterale	370 mm
Distanza di lavoro	710 - 340 mm
Larghezza max pneumatico	325 mm
Dimensioni ingombro	730 x 468 x 440h mm
Peso netto	15 kg

**S017****€ 230,00****SUPPORTO UNIVERSALE TELESCOPICO**

Regolabile in altezza ed in lunghezza, costruito in tubi quadrati di acciaio, dopo l'uso si può riporre in poco spazio, piani di appoggio rivestiti in gomma antigraffio, 4 ruote girevoli di cui 2 con freno, adatto a lavori di carrozzeria per riparazioni, preparazione e verniciatura.



Altezza min - max	840 ÷ 1320 mm
Lunghezza	225 ÷ 1380 mm
Larghezza	860 mm
Portata	100 kg
Peso netto	26 kg

0645/CC**€ 95,60****SGABELLO CON 3 CASSETTI**

Dotato di 3 cassetti su cuscinetti, 3 portabombolette e vassoio porta minuterie, 4 ruote pivotanti



Dimensioni	370 x 400 x 367h mm
Dimensioni cassetto	3 - 150 x 300 x 40 h mm
Peso netto	8 kg

0645/C**€ 63,30****CARRELLO SOTTOAUTO A 6 RUOTE**

Dimensioni	1030 x 420 x 110h mm
Peso netto	6,5 kg

0645/S**€ 56,70****SGABELLO PER OFFICINA**

Con ruote pivotanti, basamento porta attrezzi, seduta con imbottitura



Dimensioni	368 x 360 x 365 mm
Peso netto	3,8 kg

0645/CP**€ 70,50****CARRELLO SOTTOAUTO IN PLASTICA**

Antiurto, con 6 ruote.



Dimensioni	1000 x 470 x 120h mm
Peso netto	4,8 kg

0645/SS**€ 69,60****CARRELLO SGABELLO SOTTOAUTO 2 IN 1**

Dimensioni carrello	1020 x 410 x 150h mm
Dimensioni sgabello	550 x 410 x 500h mm
Peso netto	9 kg

0256-
CRIC IDRAULICO A PROFILO RIBASSATO

Art.	€	Portata max	Pressione di esercizio	Altezza min-max sollevabile	Stelo	Corsa pistone	Dimensioni	Peso netto
0256/05	€ 58,00	5 ton	63 Mpa	33 ÷ 39 mm	ø 24 mm	6 mm	45 x 95 mm	0,6 kg
0256/10	€ 98,60	10 ton	63.7 Mpa	44 ÷ 55 mm	ø 38 mm	11 mm	56 x 118 mm	1,3 kg
0256/20	€ 121,00	20 ton	63.7 Mpa	52 ÷ 63 mm	ø 50 mm	11 mm	76 x 138 mm	2,6 kg
0256/30	€ 133,00	30 ton	63.7 Mpa	60 ÷ 72 mm	ø 63 mm	12 mm	95 x 158 mm	4,4 kg
0256/50	€ 190,00	50 ton	63.7 Mpa	66 ÷ 78 mm	ø 70 mm	12 mm	118 x 186 mm	6,7 kg

0062-
CRIC A BOTTIGLIA

Cric idraulico, garantisce un'ottima stabilità grazie alle sue ridotte dimensioni, facile da trasportare e da utilizzare



Art.	€	Portata	Altezza min.	Alzata	Regolazione	Dimensioni base	Diametro pistone	Peso netto
0062/2	€ 26,30	2 ton	181 mm	116 mm	48 mm	90 x 85 mm	Ø 22 mm	2,7 kg
0062/5	€ 41,00	5 ton	220 mm	127 mm	70 mm	115 x 100 mm	Ø 32 mm	4,3 kg
0062/10	€ 55,10	10 ton	230 mm	150 mm	80 mm	125 x 110 mm	Ø 40 mm	6,5 kg
0062/15	€ 81,30	15 ton	230 mm	150 mm	80 mm	140 x 135 mm	Ø 48 mm	8,3 kg
0062/20	€ 92,80	20 ton	242 mm	150 mm	60 mm	155 x 145 mm	Ø 53 mm	10,5 kg
0062/32	€ 178,00	32 ton	285 mm	180 mm	- mm	170 x 160 mm	Ø 56 mm	13,5 kg
0062/50	€ 306,00	50 ton	295 mm	180 mm	- mm	215 x 175 mm	Ø 85 mm	29 kg

**0010****€ 853,00****CARRELLO REGOLABILE IN ALTEZZA**

A pantografo con maniglia ripiegabile, dotato di sistema di bloccaggio meccanico della piattaforma e ruote pivotanti con freno



Portata	500 kg
Dimensioni tavola	850 x 500 x 50 mm
Alzata	290 ÷ 880 mm
Peso netto	86 kg

**0075****€ 780,00****CARRELLO REGOLABILE IN ALTEZZA**

A pantografo con maniglia ripiegabile dotato di sistema di bloccaggio meccanico della piattaforma, ruote pivotanti con freno



Portata	300 kg
Dimensioni tavola	850 x 500 x 50 mm
Alzata	290 ÷ 880 mm
Peso netto	78 kg

**0467****€ 1010,00****CARRELLO REGOLABILE IN ALTEZZA**

A doppio pantografo con maniglia fissa. dotato di sistema di bloccaggio meccanico della piattaforma e ruote pivotanti con freno



Portata	350 kg
Dimensioni tavola	910 x 500 x 53 mm
Alzata	335 ÷ 1300 mm
Peso netto	92 kg



C650 € 180,00

CARRELLO A 3 VASCHE

Robusto e pratico da assemblare, 2 ruote fisse e 2 ruote girevoli



Dimensioni	800 x 450 x 800h mm
Spessore lamiera	2 mm
Ruote	ø 80 mm
Portata	100 kg
Peso netto	23 kg

C750 € 296,00

CARRELLO A 3 VASCHE

Robusto e pratico da assemblare, 2 ruote fisse e 2 ruote girevoli



Dimensioni	940 x 600 x 870h mm
Spessore lamiera	2,3 mm
Ruote	ø 150 mm
Portata	200 kg
Peso netto	52 kg

C065/2 € 190,00

CARRELLO A 2 VASCHE POLIPROPILENE

Leggero, robusto e pratico da assemblare, 2 ruote fisse e 2 ruote girevoli



Dimensioni	1010 x 440 x 840h mm
Ruote	ø 125 mm
Portata	250 kg
Temperatura di esercizio	-20 °C a +50 °C
Peso netto	15,5 kg

C075/2 € 249,00

CARRELLO A 2 VASCHE POLIPROPILENE

Leggero, robusto e pratico da assemblare, 2 ruote fisse e 2 ruote girevoli



Dimensioni	1170 x 652 x 840h mm
Ruote	ø 125 mm
Portata	250 kg
Peso netto	22,5 kg

C009 € 400,00

CARRELLO CON PIANO IN LEGNO

In acciaio, con 2 ruote fisse e 2 ruote girevoli con freno



Dimensioni ingombro	1000 x 800 x 810 h mm
Spessore lamiera	2 mm
Spessore piano	36 mm
Ruote	ø 150 mm
Portata	150 kg
Peso netto	52 kg

Cx

CARRELLO CON PIATTAFORMA IN PVC

Manico pieghevole, 2 ruote fisse e 2 ruote girevoli



Art.	€	Ruote	Portata	Dimensioni piattaforma	Altezza	Peso netto
C150	€ 70,50	ø 100 mm	150 kg	700 x 450 mm	820 mm	7,8 kg
C300	€ 187,00	ø 125 mm	300 kg	900 x 600 mm	890 mm	13,4 kg



C1102 € 92,80

CARRELLO GOMMATO

Per vasi e scatole, con manopole antinfortunistiche, verniciatura epossidica



Ruote pneumatiche	Ø 260 x 85 mm
Portata	200 kg
Dimensioni pala	450 x 215 mm
Peso netto	8,5 kg

C182 € 190,00

CARRELLO GOMMATO

In alluminio



Ruote pneumatiche	Ø 260 x 85 mm
Portata	200 kg
Dimensioni pala	300 x 205 mm
Peso netto	6 kg

C189 € 94,40

CARRELLO MULTIUSO

Gommato per il trasporto di legna, vasi, scatole e oggetti vari. robusto, maneggevole e versatile. manici di sicurezza in plastica



Ruote pneumatiche	Ø 260 x 85 mm
Portata	150 kg
Dimensioni pala	400 x 250 mm
Dimensioni pala mobile	340 x 390 mm
Peso netto	11,5 kg

0461 € 20,80

RUOTA IN POLIURETANO

Non perforabile di dimensioni 260 x 85mm, con cuscinetti a rulli, foro Ø 20mm e riduzione da 20mm a 18mm, per carrelli con albero ruota 18-20mm.



Dimensioni ruota	250 x 75 mm
Dimensioni foro	Ø 20 - 18 x 74 mm

P019 € 168,00

PIATTAFORMA ANTISCIVOLO PIEGHEVOLE

In alluminio, professionale e di facile uso, ideale per una vasta gamma di lavori in diversi settori, da quello domestico a quello auto



Portata	150 kg
Dimensioni	1260x380x500 mm
Dimensioni piattaforma	950x300 mm
Peso netto	7,5 kg

0056-

PARANCO A CATENA



Art.	€	Portata	Alzata	Peso netto
0056/1	€ 157,00	1000 kg	3000 mm	11 kg
0056/2	€ 233,00	2000 kg	3000 mm	20 kg

0237-
PARANCO A LEVA



Art.	€	Portata	Alzata	Peso netto
0237/05	€ 190,00	500 kg	1500 mm	5 kg
0237/15	€ 282,00	1500 kg	1500 mm	10 kg

0236 € 92,40
SUPPORTO A BANDIERA



Portata	300 kg
Lunghezza braccio	750 mm
Interasse fori	380 mm
Sezione	45 X 45 mm ²
Peso netto	6 kg

0602 € 287,00
PARANCO ELETTRICO



Portata	200 / 400 kg
Lunghezza cavo	18 m
Velocità	8 m/min
Motore	230 V 50 Hz 1 kW
Peso netto	16,7 kg



0600 € 320,00
PARANCO ELETTRICO



Portata	200 / 400 kg
Lunghezza cavo	18 m
Velocità	8 m / min
Motore	230 V 50 Hz 0,75 kW
Peso netto	16,7 kg



Sx
SOLLEVATORE MAGNETICO
Neodimio.

Art.	€	Portata max	Portata barre tonde	Diametro min-max sollevabile	Dimensioni	Peso netto
S0300	€ 580,00	300 kg	100 kg	50 ÷ 300 mm	189 x 163 x 92 (B) mm	9,5 kg
S0600	€ 907,00	600 kg	200 kg	70 ÷ 400 mm	267 x 198 x 129 (B) mm	19 kg
S1000	€ 1370,00	1000 kg	330 kg	75 ÷ 450 mm	350 x 277 x 156 (B) mm	36 kg





PDC4-

PENDENTI DI CATENA

“Nera” in acciaio legato a 4 bracci gr 80 con gancio accorciatore, coefficiente di sicurezza 4:1, la portata verticale è calcolata solo su 3 bracci in quanto il quarto braccio è solo per equilibrare il carico. EN 818-4.



Art.	€	Lunghezza	Portata 0°	Portata 45°	Catena	Gancio
PDC4/7/2	€ 425,00	2000 mm	3150	2240	ø 7 mm	SLF
PDC4/7/3	€ 490,00	3000 mm	3150	2240	ø 7 mm	SLF
PDC4/7/4	€ 553,00	4000 mm	3150	2240	ø 7 mm	SLF
PDC4/10/2	€ 844,00	2000 mm	6700	4750	ø 10 mm	SLF
PDC4/10/3	€ 930,00	3000 mm	6700	4750	ø 10 mm	SLF
PDC4/10/4	€ 1060,00	4000 mm	6700	4750	ø 10 mm	SLF



PDC2-

PENDENTI DI CATENA

“Nera” in acciaio legato a 2 bracci gr 80, con ganci accorciatori, coefficiente di sicurezza 4:1. EN 818-4.



Art.	€	Lunghezza	Portata 0°	Portata 45°	Catena	Gancio
PDC2/7/2	€ 206,00	2000 mm	2120	1500	ø 7 mm	SLF
PDC2/7/3	€ 219,00	3000 mm	2120	1500	ø 7 mm	SLF
PDC2/7/4	€ 247,00	4000 mm	2120	1500	ø 7 mm	SLF
PDC2/10/2	€ 315,00	2000 mm	4250	3150	ø 10 mm	SLF
PDC2/10/3	€ 348,00	3000 mm	4250	3150	ø 10 mm	SLF
PDC2/10/4	€ 418,00	4000 mm	4250	3150	ø 10 mm	SLF



PDC1-

PENDENTI DI CATENA

“Nera” in acciaio legato a 1 braccio gr 80, con gancio accorciatore, coefficiente di sicurezza 4:1. EN 818-4.



Art.	€	Lunghezza	Portata verticale	Catena	Gancio
PDC1/7/1	€ 83,70	1000 mm	1500 kg	ø 7 mm	SLF
PDC1/7/2	€ 95,60	2000 mm	1500 kg	ø 7 mm	SLF
PDC1/10/1	€ 125,00	1000 mm	3150 kg	ø 10 mm	SLF
PDC1/10/2	€ 147,00	2000 mm	3150 kg	ø 10 mm	SLF



AN2G/12/1

€ 88,80

PENDENTE A 2 BRACCI IN ACCIAIO



Fune	ø 12 mm
Lunghezza	1000 mm
Portata	30° 2600 kg
Portata	90° 2100 kg



06x

SISTEMA DI ANCORAGGIO CON NASTRO IN POLIESTERE

EN 12195-2.



Art.	€	Nastro con tenditore	Larghezza nastro	Portata	Ganci
0635	€ 29,40	5,50 + 0,50 m	35 mm	1000 kg	2
0650	€ 41,00	8,00 + 0,50 m	50 mm	2000 kg	2
0675	€ 206,00	10,00 + 1,00 m	75 mm	3000 kg	2

0635/25

€ 14,30

SISTEMA DI ANCORAGGIO CON NASTRO IN POLIESTERE

EN 12195-2.



Nastro da mm 25 con tenditore e 2 ganci	4,00 + 0,30 m
Portata	250 kg

x-1000
BRACHE PIATTE IN POLIESTERE COLORATO

Brache piatte in poliestere colorato a doppio strato, asole rivestite, coefficiente di sicurezza 7:1. EN 1492-1.

Art.	€	m	Larghezza	Colore	Lungh. asole	Portata verticale	Portata canestro	Portata canestro β 45° kg	Portata canestro β 60° kg	Portata cappio
1/1000	€ 14,20	1	50 mm	Viola	250 mm	1000 kg	2000 kg	1400	1000	800 kg
2/1000	€ 19,00	2	50 mm	Viola	250 mm	1000 kg	2000 kg	1400	1000	800 kg
3/1000	€ 22,50	3	50 mm	Viola	250 mm	1000 kg	2000 kg	1400	1000	800 kg
4/1000	€ 27,20	4	50 mm	Viola	250 mm	1000 kg	2000 kg	1400	1000	800 kg

x-2000
BRACHE PIATTE IN POLIESTERE COLORATO

A doppio strato, asole rivestite, coefficiente di sicurezza 7:1. EN 1492-1.

Art.	€	m	Larghezza	Colore	Lungh. asole	Portata verticale	Portata canestro	Portata canestro β 45° kg	Portata canestro β 60° kg	Portata cappio
1/2000	€ 18,20	1	60 mm	Verde	250 mm	2000 kg	4000 kg	2800	2000	1600 kg
2/2000	€ 26,10	2	60 mm	Verde	250 mm	2000 kg	4000 kg	2800	2000	1600 kg
3/2000	€ 33,90	3	60 mm	Verde	250 mm	2000 kg	4000 kg	2800	2000	1600 kg
4/2000	€ 41,00	4	60 mm	Verde	250 mm	2000 kg	4000 kg	2800	2000	1600 kg
5/2000	€ 51,60	5	60 mm	Verde	250 mm	2000 kg	4000 kg	2800	2000	1600 kg
6/2000	€ 60,40	6	60 mm	Verde	250 mm	2000 kg	4000 kg	2800	2000	1600 kg

x-3000
BRACHE PIATTE IN POLIESTERE COLORATO

A doppio strato, asole rivestite, coefficiente di sicurezza 7:1. EN 1492-1.

Art.	€	m	Larghezza	Colore	Lungh. asole	Portata verticale	Portata canestro	Portata canestro β 45° kg	Portata canestro β 60° kg	Portata cappio
1/3000	€ 24,90	1	90 mm	Giallo	300 mm	3000 kg	6000 kg	4200	3000	2400 kg
2/3000	€ 35,20	2	90 mm	Giallo	300 mm	3000 kg	6000 kg	4200	3000	2400 kg
3/3000	€ 49,20	3	90 mm	Giallo	300 mm	3000 kg	6000 kg	4200	3000	2400 kg
4/3000	€ 60,40	4	90 mm	Giallo	300 mm	3000 kg	6000 kg	4200	3000	2400 kg
5/3000	€ 69,60	5	90 mm	Giallo	300 mm	3000 kg	6000 kg	4200	3000	2400 kg
6/3000	€ 81,30	6	90 mm	Giallo	300 mm	3000 kg	6000 kg	4200	3000	2400 kg

FTx-1000
FUNI TONDE IN POLIESTERE

Anello chiuso con calza esterna, coefficiente di sicurezza 7:1. EN 1492-2.

Art.	€	Anello	Colore	Verticale	Portata canestro	Portata canestro β 45° kg	Portata canestro β 60° kg	Portata cappio
FT1/1000	€ 7,20	1 m	Viola	1000 kg	2000 kg	1400	1000	800 kg
FT2/1000	€ 10,10	2 m	Viola	1000 kg	2000 kg	1400	1000	800 kg
FT3/1000	€ 14,30	3 m	Viola	1000 kg	2000 kg	1400	1000	800 kg
FT4/1000	€ 18,40	4 m	Viola	1000 kg	2000 kg	1400	1000	800 kg
FT5/1000	€ 22,50	5 m	Viola	1000 kg	2000 kg	1400	1000	800 kg
FT6/1000	€ 26,80	6 m	Viola	1000 kg	2000 kg	1400	1000	800 kg

FTx-2000
FUNI TONDE IN POLIESTERE

Anello chiuso con calza esterna, coefficiente di sicurezza 7:1. EN 1492-2.

Art.	€	Anello	Colore	Verticale	Portata canestro	Portata canestro β 45° kg	Portata canestro β 60° kg	Portata cappio
FT1/2000	€ 10,10	1 m	Verde	2000 kg	4000 kg	2800	2000	1600 kg
FT2/2000	€ 12,50	2 m	Verde	2000 kg	4000 kg	2800	2000	1600 kg
FT3/2000	€ 21,00	3 m	Verde	2000 kg	4000 kg	2800	2000	1600 kg
FT4/2000	€ 26,60	4 m	Verde	2000 kg	4000 kg	2800	2000	1600 kg
FT5/2000	€ 29,50	5 m	Verde	2000 kg	4000 kg	2800	2000	1600 kg
FT6/2000	€ 35,20	6 m	Verde	2000 kg	4000 kg	2800	2000	1600 kg

FTx-3000
FUNI TONDE IN POLIESTERE

Anello chiuso con calza esterna coefficiente di sicurezza 7:1. EN 1492-2.

Art.	€	Anello	Colore	Verticale	Portata canestro	Portata canestro β 45° kg	Portata canestro β 60° kg	Portata cappio
FT1/3000	€ 12,50	1 m	Giallo	3000 kg	6000 kg	4200	3000	2400 kg
FT2/3000	€ 18,50	2 m	Giallo	3000 kg	6000 kg	4200	3000	2400 kg
FT3/3000	€ 26,60	3 m	Giallo	3000 kg	6000 kg	4200	3000	2400 kg
FT4/3000	€ 34,60	4 m	Giallo	3000 kg	6000 kg	4200	3000	2400 kg
FT5/3000	€ 40,40	5 m	Giallo	3000 kg	6000 kg	4200	3000	2400 kg
FT6/3000	€ 50,60	6 m	Giallo	3000 kg	6000 kg	4200	3000	2400 kg





0791-

ARGANO MANUALE A FUNE

Per il tiro ed il sollevamento



Art.	€	Tiro massimo	Cavo	Peso netto
0791/08	€ 373,00	800 kg	ø 8,3mm x 20m	11 kg
0791/16	€ 504,00	1600 kg	ø 11mm x 20m	24 kg
0791/32	€ 986,00	3200 kg	ø 16mm x 20m	50 kg

0066

€ 34,90

TENDI CAVO CON DOPPIO CRICCHETTO



Tiro massimo	800 kg
Diametro cavo	ø 5 mm
Lunghezza massima	2 m
Peso netto	2,7 kg

0070/C

€ 45,80

ARGANO MANUALE

Zincato con cavo e gancio. manovella ergonomica



Tiro massimo	500 kg
Larghezza gola	50 mm
Diametro esterno rocchetto	133 mm
Diametro minimo rocchetto	40 mm
Dimensioni cavo	ø 4,5 mm x 10 m
Dimensioni base	140 x 90 mm

0070

€ 35,30

ARGANO MANUALE

Struttura in acciaio zincato. Manovella ergonomica.



Tiro massimo	500 kg
Larghezza gola	50 mm
Diametro esterno rocchetto	133 mm
Diametro minimo rocchetto	40 mm
Dimensioni base	140 x 90 mm

0590

€ 74,00

ARGANO MANUALE CON FRENO



Tiro massimo	450 kg
Larghezza gola	49 mm
Diametro esterno rocchetto	110 mm
Diametro minimo rocchetto	45 mm
Dimensioni ingombro senza leva	170 x 150 x 125h mm



0068/S € 3510,00
TRANSPALLET CON BILANCIA E STAMPANTE

Non idonei nei rapporti con terzi - funzione tara alimentazione con batteria ricaricabile - battistrada in poliuretano



Portata	2000 kg
Capacità pesatura	2000 kg
Altezza forche	88 ÷ 200 mm
Dimensioni forche	1150 x 568 mm
Lettura	1 kg
Precisione	±2 kg
Stampante	Si/Yes
Ruota anteriore	Doppia/Double
Peso netto	160 kg

0068L € 2340,00
TRANSPALLET CON BILANCIA

Transpallet con bilancia non idonei nei rapporti con terzi - funzione tara alimentazione con batterie sostituibili



Portata	2000 kg
Capacità pesatura	2000 kg
Altezza forche	85 ÷ 175 mm
Dimensioni forche	1150 x 570 mm
Lettura	0,5 kg
Precisione	±0,05% kg
Ruota anteriore	Doppia
Peso netto	125 kg

0028R € 686,00
TRANSPALLET MANUALE RIBASSATO

Con battistrada in poliuretano.



Portata	2500 kg
Altezza forche	63 ÷ 165 mm
Dimensioni forche	1150 x 540 mm
Spessore telaio	3 mm
Ruota anteriore	Doppia
Peso netto	68,5 kg

0028 € 597,00
TRANSPALLET MANUALE

Con battistrada in poliuretano



Portata	2500 kg
Altezza forche	85 ÷ 200 mm
Dimensioni forche	1150 x 540 mm
Spessore telaio	3 mm
Ruota anteriore	Doppia
Peso netto	71,5 kg

0064 € 690,00
TRANSPALLET MANUALE

Con battistrada in poliuretano



Portata	2500 kg
Altezza forche	85 ÷ 200 mm
Dimensioni forche	900 x 540 mm
Spessore telaio	3 mm
Ruota anteriore	Singola
Peso netto	68,5 kg

S2/800 € 1190,00
SOLLEVATORE PER PALLETS

A pantografo



Portata	1000 kg
Altezza forche	85 ÷ 800 mm
Dimensioni forche	1170 x 540 mm
Battistrada	Poliuretano
Ruota anteriore	Singola
Peso netto	117 kg



0782
€ 1130,00
SOLLEVATORE CON PIATTAFORMA E FORCHE

Portata	400 kg
Altezza forche	85 ÷ 1500 mm
Dimensioni forche	545 x 650 mm
Piattaforma	576 x 650 mm
Ruote sterzanti	Ø 127 x 40 mm
Ruote fisse	Ø 75 x 40 mm
Battistrada	Poliuretano
Dimensioni	1100 x 600 x 1725h mm
Peso netto	95 kg

0143A
€ 1910,00
SOLLEVATORE PER PALLET

Con freno e pedale di sollevamento



Portata	1000 kg
Altezza forche	90 ÷ 1600 mm
Dimensioni forche	1150 x 550 mm
Sezione forche	160 x 55 mm
Altezza montante	2100 mm
Battistrada	Poliuretano
Ruota anteriore	Doppia
Dimensioni	920 x 1670 x 2100h mm
Peso netto	250 kg

0143/25
€ 2110,00
SOLLEVATORE MANUALE PER PALLET











Con montante telescopico doppio, freno e pedale di sollevamento













Portata	1000 / 800 kg
Altezza forche	75 ÷ 1600 ÷ 2500 mm
Dimensioni forche	1150 x 550 mm
Sezione forche	160 x 55 mm
Altezza montante	1840 mm
Battistrada	Poliuretano
Ruota anteriore	Doppia
Dimensioni	1670 x 920 x 1840h mm
Peso netto	310 kg











	CHIAVI DI MANOVRA
p. 384	 — Chiavi a cricchetto
p. 385	 — Chiavi fisse
p. 385	 — Chiavi combinate
p. 388	 — Chiavi poligonali
p. 390	 — Chiavi a tubo
p. 393	 — Chiavi esagonali
p. 395	 — Chiavi torx
p. 397	 — Chiavi a T
p. 398	 — Chiavi per filtro
p. 399	 — Chiavi dinamometriche





	CHIAVI A BUSSOLA ED ESTRATTORI
p. 402	 — Leve a cricchetto
p. 404	 — Chiavi a bussola
p. 418	 — Chiavi a bussola ad impatto
p. 425	 — Estrattori





	GIRAVITI E RIVETTATRICI
p. 427	 — Giraviti a bussola
p. 429	 — Giraviti
p. 433	 — Giraviti di precisione
p. 434	 — Inserti e portainseriti
p. 440	 — Rivettatrici a leva

	PINZE, MARTELLI, LIME, LEVE E SCALPELLI
p. 442	 — Pinze
p. 446	 — Pinze grip e a morsetto
p. 446	 — Pinze idrauliche e giratubo
p. 448	 — Martelli e mazzuoli
p. 451	 — Cacciaspine e scalpelli
p. 453	 — Lime
p. 456	 — Leve

	CUTTER, SBAVATORI E FORBICI
p. 457	 — Cutter
p. 459	 — Sbavatori
p. 461	 — Seghetti
p. 462	 — Forbici e cesoie
p. 463	 — Tagliatubi

	ASSORTIMENTI E FISSAGGIO
p. 466	 — Punti per fissatrici e chiodatrici
p. 466	 — Assortimenti

	EDILIZIA ED IMBALLAGGIO
p. 471	 — Pistole per prodotti chimici
p. 472	 — Cazzuole, spatole e frattoni
p. 473	 — Materiale per imballaggio

	SERIE DI UTENSILI
p. 474	 — Carrelli con utensili
p. 478	 — Serie di utensili in termoformati
p. 484	 — Valigette con utensili

0690- PRO

CHIAVE COMBINATA CON TESTA A CRICCHETTO SNODATA
DIN 3113.

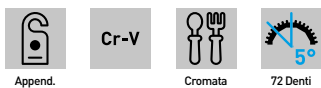

Art.	€	Misura	Lunghezza
0690/08	€ 10,90	8 mm	150 mm
0690/09	€ 10,90	9 mm	150 mm
0690/10	€ 13,50	10 mm	160 mm
0690/11	€ 13,50	11 mm	170 mm
0690/12	€ 13,50	12 mm	170 mm
0690/13	€ 13,50	13 mm	185 mm
0690/14	€ 17,20	14 mm	205 mm
0690/15	€ 17,20	15 mm	205 mm
0690/16	€ 17,20	16 mm	230 mm
0690/17	€ 18,50	17 mm	230 mm
0690/18	€ 19,50	18 mm	250 mm
0690/19	€ 20,80	19 mm	250 mm

0700-

CHIAVI A CRICCHETTO

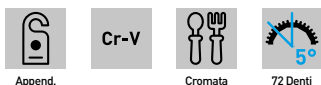

Art.	€	Misura	Lunghezza
0700/08	€ 8,60	8 mm	140 mm
0700/09	€ 8,70	9 mm	150 mm
0700/10	€ 8,80	10 mm	160 mm
0700/11	€ 9,60	11 mm	165 mm
0700/12	€ 10,00	12 mm	172 mm
0700/13	€ 10,70	13 mm	180 mm
0700/14	€ 11,40	14 mm	190 mm
0700/15	€ 12,10	15 mm	220 mm
0700/16	€ 12,90	16 mm	221 mm
0700/17	€ 14,20	17 mm	225 mm
0700/18	€ 14,60	18 mm	238 mm
0700/19	€ 15,10	19 mm	248 mm

0690/07P PRO € 99,00

SERIE CHIAVI COMBINATE CON TESTA A CRICCHETTO SNODATA
DIN 3113.

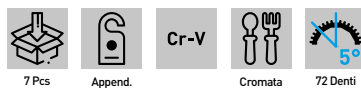

Misure 8 - 10 - 11 - 13 - 15 - 17 - 19 mm

0690/12P PRO € 158,00

SERIE CHIAVI COMBINATE CON TESTA A CRICCHETTO SNODATA
DIN 3113.

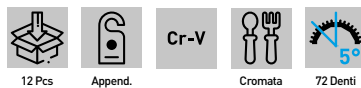

Misure 8 - 9 - 10 - 11 - 12 - 13 - 14 - 15 - 16 - 17 - 18 - 19 mm

0700/07P € 69,30

SERIE CHIAVI COMBINATE CON TESTA A CRICCHETTO

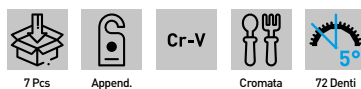

Misure 8 - 10 - 11 - 13 - 15 - 17 - 19 mm

0700/12P € 125,00

SERIE CHIAVI COMBINATE CON TESTA A CRICCHETTO

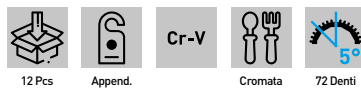

Misure 8 - 9 - 10 - 11 - 12 - 13 - 14 - 15 - 16 - 17 - 18 - 19 mm



0546

€ 52,60

SERIE CHIAVI COMBinate SATINATE



Misure 6 - 7 - 8 - 9 - 10 - 11 - 12 - 13 - 14 - 17 - 19 - 22 mm

0544

€ 138,00

SERIE CHIAVI COMBinate SATINATE



Misure 6-7-8-9-10-11-12-13-14-15-16-17-18-19-20-21-22-23-24-25-26-27-28-30-32 mm

0201-

CHIAVI FISSE CROMATE, LUCIDATE A SPECCHIO

DIN 3110.

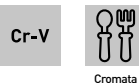

Art.	€	Misura	Lunghezza
0201/06X07	€ 1,99	6x7 mm	122 mm
0201/08X09	€ 2,60	8x9 mm	140 mm
0201/10X11	€ 2,60	10x11 mm	156 mm
0201/12X13	€ 3,74	12x13 mm	172 mm
0201/14X15	€ 3,74	14x15 mm	190 mm
0201/16X17	€ 4,63	16x17 mm	190 mm
0201/18X19	€ 5,60	18x19 mm	225 mm
0201/20X22	€ 6,40	20x22 mm	235 mm
0201/21X23	€ 7,50	21x23 mm	250 mm
0201/24X27	€ 8,10	24x27 mm	265 mm

Art.	€	Misura	Lunghezza
0201/25X28	€ 10,20	25x28 mm	280 mm
0201/30X32	€ 10,80	30x32 mm	300 mm
0201/32X36	€ 11,90	32x36 mm	325 mm
0201/34X36	€ 12,70	34x36 mm	325 mm
0201/35X38	€ 13,70	35x38 mm	330 mm
0201/36X41	€ 15,50	36x41 mm	360 mm
0201/41X46	€ 26,40	41x46 mm	400 mm
0201/46X50	€ 35,50	46x50 mm	450 mm
0201/50X55	€ 51,80	50x55 mm	485 mm
0201/55X60	€ 59,00	55x60 mm	520 mm

0200

€ 31,90

SERIE CHIAVI FISSE CROMATE, LUCIDATE A SPECCHIO

DIN 3110.



Misure 6x7 - 8x9 - 10x11 - 12x13 - 14x15 - 16x17 - 18x19 - 20x22 mm

0201

€ 73,80

SERIE CHIAVI FISSE CROMATE, LUCIDATE A SPECCHIO

DIN 3110.



Misure 6x7 - 8x9 - 10x11 - 12x13 - 14x15 - 16x17 - 18x19 - 20x22 - 21x23 - 24x27 - 25x28 - 30x32 mm

0208-

CHIAVI COMBinate CROMATE, LUCIDATE A SPECCHIO
DIN 3113.

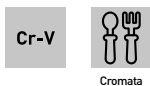

Art.	€	Misura	Lunghezza
0208/06	€ 3,74	6 mm	100 mm
0208/07	€ 3,74	7 mm	110 mm
0208/08	€ 3,74	8 mm	120 mm
0208/09	€ 3,74	9 mm	130 mm
0208/10	€ 3,83	10 mm	140 mm
0208/11	€ 3,83	11 mm	150 mm
0208/12	€ 3,83	12 mm	160 mm
0208/13	€ 3,83	13 mm	170 mm
0208/14	€ 5,70	14 mm	180 mm
0208/15	€ 5,70	15 mm	190 mm
0208/16	€ 5,70	16 mm	200 mm
0208/17	€ 6,40	17 mm	210 mm
0208/18	€ 6,40	18 mm	220 mm
0208/19	€ 7,50	19 mm	230 mm
0208/20	€ 9,30	20 mm	240 mm
0208/21	€ 9,30	21 mm	250 mm
0208/22	€ 10,80	22 mm	260 mm
0208/23	€ 11,30	23 mm	270 mm
0208/24	€ 12,20	24 mm	280 mm
0208/25	€ 12,20	25 mm	290 mm
0208/26	€ 12,20	26 mm	300 mm
0208/27	€ 13,30	27 mm	310 mm
0208/28	€ 13,30	28 mm	320 mm
0208/30	€ 13,30	30 mm	340 mm
0208/32	€ 15,20	32 mm	360 mm
0208/34	€ 16,30	34 mm	380 mm
0208/36	€ 17,30	36 mm	400 mm
0208/38	€ 19,10	38 mm	400 mm
0208/41	€ 24,60	41 mm	440 mm
0208/46	€ 33,60	46 mm	490 mm
0208/50	€ 39,20	50 mm	530 mm

0199P-

CHIAVI COMBinate CROMATE, LUCIDATE A SPECCHIO
DIN 3113 Misure in pollici

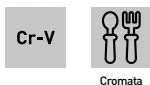

Art.	€	Misura	Lunghezza
0199P/1/4	€ 2,21	1/4"	100 mm
0199P/5/16	€ 2,42	5/16"	120 mm
0199P/3/8	€ 3,02	3/8"	140 mm
0199P/7/16	€ 3,12	7/16"	150 mm
0199P/1/2	€ 3,12	1/2"	170 mm
0199P/9/16	€ 3,93	9/16"	180 mm
0199P/5/8	€ 4,54	5/8"	200 mm
0199P/11/16	€ 4,74	11/16"	210 mm
0199P/3/4	€ 5,40	3/4"	230 mm
0199P/13/16	€ 6,40	13/16"	250 mm
0199P/7/8	€ 7,00	7/8"	260 mm
0199P/15/16	€ 10,20	15/16"	280 mm
0199P/1	€ 10,70	1"	290 mm

0199

€ 52,60

SERIE CHIAVI COMBinate CROMATE, LUCIDATE A SPECCHIO
DIN 3113.



Misure 6 - 7 - 8 - 9 - 10 - 11 - 12 - 13 - 14 - 17 - 19 - 22 mm

0208

€ 126,00

SERIE CHIAVI COMBinate CROMATE, LUCIDATE A SPECCHIO
DIN 3113.



Misure 6-7-8-9-10-11-12-13-14-15-16-17-18-19-20-21-22-23-24-25-26-27-28-30-32 mm

0204

€ 161,00

SERIE CHIAVI COMBinate CROMATE, LUCIDATE A SPECCHIO
DIN 3113.

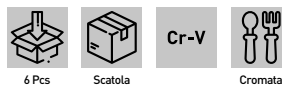

Misure 34 - 36 - 38 - 41 - 46 - 50 mm

0199P

€ 62,20

SERIE CHIAVI COMBinate CROMATE, LUCIDATE A SPECCHIO
DIN 3113 Misure in pollici



Misura 1/4" - 5/16" - 3/8" - 7/16" - 1/2" - 9/16" - 5/8" - 11/16" - 3/4" - 13/16" - 7/8" - 15/16" - 1"



0222-

CHIAVI FISSE

DIN 3110.



Art.	€	Misura	Lunghezza
0222/06X07	€ 1,37	6x7 mm	122 mm
0222/08X09	€ 1,59	8x9 mm	140 mm
0222/10X11	€ 1,81	10x11 mm	155 mm
0222/12X13	€ 2,04	12x13 mm	170 mm
0222/14X15	€ 2,16	14x15 mm	190 mm
0222/16X17	€ 2,61	16x17 mm	205 mm
0222/18X19	€ 2,95	18x19 mm	220 mm
0222/20X22	€ 3,40	20x22 mm	235 mm
0222/21X23	€ 4,54	21x23 mm	250 mm
0222/24X27	€ 7,50	24x27 mm	265 mm
0222/25X28	€ 7,50	25x28 mm	280 mm
0222/30X32	€ 8,20	30x32 mm	300 mm

0224-

CHIAVI COMBinate

DIN 3113.

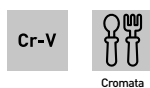

Art.	€	Misura	Lunghezza
0224/06	€ 1,25	6 mm	100 mm
0224/07	€ 1,25	7 mm	110 mm
0224/08	€ 1,25	8 mm	120 mm
0224/09	€ 1,31	9 mm	130 mm
0224/10	€ 1,37	10 mm	140 mm
0224/11	€ 1,67	11 mm	150 mm
0224/12	€ 1,67	12 mm	160mm
0224/13	€ 1,67	13 mm	170 mm
0224/14	€ 2,07	14 mm	180 mm
0224/15	€ 2,07	15 mm	190 mm
0224/16	€ 2,07	16 mm	200 mm
0224/17	€ 2,07	17 mm	210 mm
0224/18	€ 2,07	18 mm	220 mm
0224/19	€ 3,52	19 mm	230 mm
0224/20	€ 5,20	20 mm	240 mm
0224/21	€ 5,40	21 mm	250 mm
0224/22	€ 5,40	22 mm	260 mm
0224/23	€ 5,50	23 mm	270 mm
0224/24	€ 5,50	24 mm	280 mm
0224/25	€ 6,10	25 mm	290 mm
0224/26	€ 6,90	26 mm	300 mm
0224/27	€ 7,90	27 mm	310 mm
0224/28	€ 9,30	28 mm	320 mm
0224/30	€ 9,90	30 mm	340 mm
0224/32	€ 11,30	32 mm	360 mm
0224/34	€ 12,20	34 mm	380 mm
0224/36	€ 17,30	36 mm	400 mm

0221

SERIE CHIAVI FISSE

DIN 3110.

€ 16,70



Misure 6x7 - 8x9 - 10x11 - 12x13 - 14x15 - 16x17 - 18x19 - 20x22 mm

0222

SERIE CHIAVI FISSE

DIN 3110.

€ 40,40



Misure 6x7 - 8x9 - 10x11 - 12x13 - 14x15 - 16x17 - 18x19 - 20x22 - 21x23 - 24x27 - 25x28 - 30x32 mm

0073

SERIE CHIAVI COMBinate

DIN 3113.

€ 18,10



Misure 6 - 7 - 8 - 9 - 10 - 11 - 12 - 13 - 14 - 17 - 19 - 22 mm

0223

SERIE CHIAVI COMBinate

DIN 3113.

€ 71,60



Misure 6-7-8-9-10-11-12-13-14-15-16-17-18-19-20-21-22-23-24-25-26-27-28-30-32 mm

0476-

CHIAVI POLIGONALI CROMATE, LUCIDATE A SPECCHIO

DIN 838.

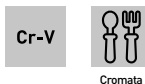

Art.	€	Misura	Lunghezza
0476/06X07	€ 2,29	6 x 7 mm	165 mm
0476/08X09	€ 2,49	8 x 9 mm	180 mm
0476/10X11	€ 2,60	10 x 11 mm	195 mm
0476/12X13	€ 2,71	12 x 13 mm	215 mm
0476/14X15	€ 3,33	14 x 15 mm	240 mm
0476/16X17	€ 3,74	16 x 17 mm	260 mm
0476/18X19	€ 4,14	18 x 19 mm	320 mm
0476/20X22	€ 5,80	20 x 22 mm	320 mm
0476/21X23	€ 6,30	21 x 23 mm	325 mm
0476/24X27	€ 8,10	24 x 27 mm	335 mm
0476/25X28	€ 9,30	25 x 28 mm	345 mm
0476/30X32	€ 11,30	30 x 32 mm	360 mm

0477

€ 28,10

SERIE CHIAVI POLIGONALI CROMATE, LUCIDATE A SPECCHIO

DIN 838.



0476

€ 64,40

SERIE CHIAVI POLIGONALI CROMATE, LUCIDATE A SPECCHIO

DIN 838.



Misure 6x7 - 8x9 - 10x11 - 12x13 - 14x15 - 16x17 - 18x19 - 20x22 mm



Misure 6x7 - 8x9 - 10x11 - 12x13 - 14x15 - 16x17 - 18x19 - 20x22 - 21x23 - 24x27 - 25x28 - 30x32 mm

0895-

PRO

CHIAVI A FORCHETTA A PERCUSSIONE

DIN 133.



Art.	€	Misura	Lunghezza
0895/24	€ 12,90	24 mm	160 mm
0895/27	€ 13,90	27 mm	180 mm
0895/30	€ 15,50	30 mm	195 mm
0895/32	€ 16,70	32 mm	195 mm
0895/36	€ 19,70	36 mm	215 mm
0895/38	€ 22,10	38 mm	215 mm
0895/41	€ 25,20	41 mm	235 mm
0895/46	€ 28,70	46 mm	255 mm
0895/50	€ 39,20	50 mm	280 mm
0895/55	€ 45,40	55 mm	310 mm
0895/60	€ 54,40	60 mm	320 mm
0895/65	€ 76,60	65 mm	345 mm
0895/70	€ 95,80	70 mm	370 mm

0896-

PRO

CHIAVI POLIGONALI A PERCUSSIONE

DIN 7444.



Art.	€	Misura	Lunghezza
0896/24	€ 12,90	24 mm	160 mm
0896/27	€ 13,90	27 mm	180 mm
0896/30	€ 15,50	30 mm	195 mm
0896/32	€ 16,70	32 mm	195 mm
0896/36	€ 19,70	36 mm	205 mm
0896/38	€ 22,10	38 mm	215 mm
0896/41	€ 25,20	41 mm	230 mm
0896/46	€ 28,70	46 mm	240 mm
0896/50	€ 35,30	50 mm	255 mm
0896/55	€ 40,30	55 mm	270 mm
0896/60	€ 49,40	60 mm	280 mm
0896/65	€ 71,60	65 mm	300 mm
0896/70	€ 89,80	70 mm	325 mm



0196-

CHIAVI COMBinate CORTE CROMATE, LUCIDATE A SPECCHIO

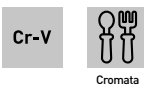

Art.	€	Misura	Lunghezza
0196/10	€ 2,32	10 mm	95 mm
0196/11	€ 2,52	11 mm	105 mm
0196/12	€ 2,72	12 mm	105 mm
0196/13	€ 3,02	13 mm	110 mm
0196/14	€ 3,23	14 mm	115 mm
0196/15	€ 3,53	15 mm	115 mm
0196/16	€ 3,73	16 mm	125 mm
0196/17	€ 3,83	17 mm	130 mm
0196/18	€ 4,14	18 mm	140 mm
0196/19	€ 4,23	19 mm	140 mm

0134-

CHIAVE POLIGONALE PIATTA

DIN 837.

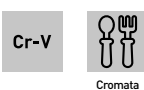

Art.	€	Misura	Lunghezza
0134/06X07	€ 3,63	6 x 7 mm	100 mm
0134/08X09	€ 4,03	8 x 9 mm	115 mm
0134/10X11	€ 4,23	10 x 11 mm	130 mm
0134/12X13	€ 4,54	12 x 13 mm	145 mm
0134/14X15	€ 4,94	14 x 15 mm	160 mm
0134/16X17	€ 5,40	16 x 17 mm	170 mm
0134/18X19	€ 5,80	18 x 19 mm	185 mm
0134/20X22	€ 6,50	20 x 22 mm	205 mm

0196

€ 26,40

SERIE CHIAVI COMBinate CORTE CROMATE, LUCIDATE A SPECCHIO



Misure 10-11-12-13-14-15-16-17-18-19 mm

0134S

€ 31,90

SERIE CHIAVI POLIGONALI PIATTE

DIN 837.

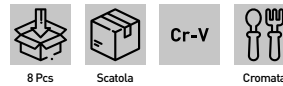

Misure 100 - 6x7 mm, 115 - 8x9 mm, 130 - 10x11 mm, 145 - 12x13 mm, 160 - 14x15 mm, 170 - 16x17 mm, 185 - 18x19 mm, 205 - 20x22 mm

0187

€ 38,30

SERIE CHIAVI COMBinate MULTILOCK

DIN 3113, adatte per dadi e bulloni metrici, a pollici, torx e XZN.

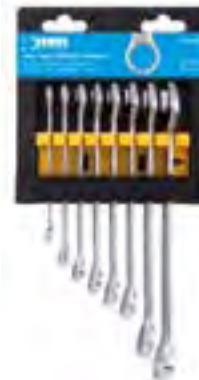

Misure 8 - 10 - 11 - 12 - 13 - 14 - 17 - 19 mm
 Misure in pollici 5/16" - 3/8" - 7/16" - 15/32" - 1/2" - 9/16" - 11/16" - 3/4"
 Misure torx E10 - E12 - E14 - E16 - E18 - E22 - E24
 Misure XZN M8 - M10 - M11 - M12 - M13 - M14 - M17 - M19

0541S

€ 29,30

SERIE CHIAVI PER RACCORDI

DIN 3118, da 8mm a 14mm esagonali, da 17mm a 22mm poligonali.



Misure 140-8x10 mm, 150-9x11 mm, 175-11x13 mm, 175-12x14 mm, 210-17x19 mm, 220-19x22 mm

0614-

CHIAVI A MEZZALUNA

DIN 838.



Art.	€	Misura
0614/08X10	€ 4,54	8 x 10 mm
0614/10X12	€ 4,91	10 x 12 mm
0614/11X13	€ 5,30	11 x 13 mm
0614/13X15	€ 5,70	13 x 15 mm
0614/14X17	€ 6,80	14 x 17 mm
0614/16X18	€ 8,40	16 x 18 mm
0614/19X22	€ 9,10	19 x 22 mm

0084-

CHIAVI INGLESE CROMATE

DIN 3117.



Art.	€	Misura	Apertura
0084/150	€ 5,40	6"-150 mm	18 mm
0084/250	€ 9,60	10"- 250 mm	30 mm
0084/375	€ 27,10	15"- 375 mm	48 mm

0614

€ 45,40

SERIE CHIAVI A MEZZALUNA

DIN 838.



Misure 8x10 - 10x12 - 11x13 - 13x15 - 14x17 - 16x18 - 19x22 mm



0714

NEW € 119,00

SET CHIAVI A SETTORE

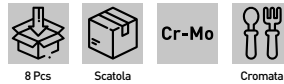

Serie 35 + 120
Misure 35+60 60+90 90+120



0266

€ 1,58

CHIAVE PER BOMBOLA GAS

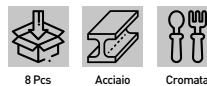

Misura 25 mm
Pack 10

0340S

€ 58,40

SERIE CHIAVI A DOPPIA BUSSOLA SNODATE

Ideali per svitare o avvitare dadi e bulloni situati in posizioni difficili da raggiungere



Misure 8x9-10x11-12x13-14x15-16x17-18x19 mm





0393- **NEW**

CHIAVI A PIPA DOPPIE ESAGONALI-POLIGONALI



Art.	€	Misura	Lunghezza
0393/06	€ 5,70	6 mm	100 mm
0393/07	€ 5,70	7 mm	105 mm
0393/08	€ 5,70	8 mm	115 mm
0393/09	€ 5,90	9 mm	120 mm
0393/10	€ 6,10	10 mm	130 mm
0393/11	€ 6,80	11 mm	135 mm
0393/12	€ 7,10	12 mm	145 mm
0393/13	€ 7,70	13 mm	150 mm
0393/14	€ 8,20	14 mm	160 mm
0393/15	€ 8,60	15 mm	170 mm
0393/16	€ 9,00	16 mm	180 mm
0393/17	€ 9,70	17 mm	185 mm
0393/18	€ 10,80	18 mm	200 mm
0393/19	€ 11,60	19 mm	200 mm
0393/20	€ 13,00	20 mm	210 mm
0393/21	€ 13,70	21 mm	220 mm
0393/22	€ 14,80	22 mm	230 mm

0442- **PRO**

CHIAVI A TUBO ESAGONALI

DIN 899, lucidata a specchio con corpo esagonale.

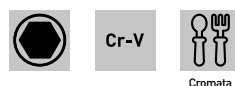

Art.	€	Misura	Lunghezza
0442/06X07	€ 6,80	6 x 7 mm	105 mm
0442/08X09	€ 7,30	8 x 9 mm	110 mm
0442/10X11	€ 7,90	10 x 11 mm	120 mm
0442/12X13	€ 8,80	12 x 13 mm	140 mm
0442/14X15	€ 9,90	14 x 15 mm	145 mm
0442/16X17	€ 11,30	16 x 17 mm	155 mm
0442/18X19	€ 13,80	18 x 19 mm	165 mm
0442/20X22	€ 17,30	20 x 22 mm	170 mm

0393/A **NEW** € 103,00

SERIE CHIAVI A PIPA DOPPIE ESAGONALI-POLIGONALI



Misure 6-7-8-10-11-12-13-14-17-19

0393 € 76,60

SERIE CHIAVI A PIPA ESAGONALI

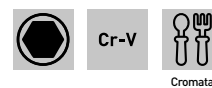

Misure 6 - 7 - 8 - 10 - 11 - 12 - 13 - 14 - 17 - 19 - 22 mm

0442 **PRO** € 88,70

SERIE CHIAVI A TUBO ESAGONALI

DIN 899, lucidate a specchio con corpo esagonale.

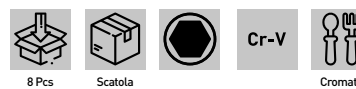

Misure 105 - 6x7 mm, 110 - 8x9 mm, 120 - 10x11 mm, 140 - 12x13 mm, 145 - 14x15 mm, 155 - 16x17 mm, 165 - 18x19 mm, 170 - 20x22 mm

0540-

CHIAVI A TUBO

Esagonali tipo leggero



Acciaio

Satinata

Art.	€	Misura	Lunghezza
0540/06X07	€ 2,12	6 x 7 mm	110 mm
0540/08X09	€ 2,24	8 x 9 mm	120 mm
0540/10X11	€ 2,28	10 x 11 mm	125 mm
0540/12X13	€ 2,42	12 x 13 mm	135 mm
0540/14X15	€ 2,58	14 x 15 mm	135 mm
0540/16X17	€ 3,02	16 x 17 mm	150 mm
0540/18X19	€ 3,40	18 x 19 mm	160 mm
0540/20X22	€ 3,79	20 x 22 mm	170 mm

€ 18,50

0540S

SERIE DI CHIAVI A TUBO

Tipo leggero, con spina di manovra a 3 diametri

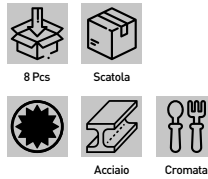

8 Pcs

Scatola



Acciaio

Cromata



Misure

6x7 8x9 10x11 12x13 14x15 16x17 18x19 20x22 mm

0540/3

€ 3,02

SPINA DI MANOVRA

A 3 diametri per chiavi a tubo



Acciaio

Cromata



Lunghezza

165 mm

ø

9,5 - 7,5 - 6 mm





0090-

CHIAVI MASCHIO ESAGONALI

DIN 911.



Art.	€	L1	L2	Pack
0090/015	€ 0,64	45 mm	14 mm	10
0090/02	€ 0,64	50 mm	16 mm	10
0090/025	€ 0,64	56 mm	18 mm	10
0090/03	€ 0,69	63 mm	20 mm	10
0090/04	€ 0,69	70 mm	25 mm	10
0090/05	€ 1,04	80 mm	28 mm	10
0090/06	€ 1,25	90 mm	32 mm	10
0090/08	€ 1,88	100 mm	36 mm	5
0090/10	€ 2,29	112 mm	40 mm	5
0090/12	€ 3,52	125 mm	45 mm	5
0090/14	€ 5,00	140 mm	56 mm	5
0090/17	€ 6,50	160 mm	63 mm	5
0090/19	€ 10,50	180 mm	70 mm	5

0558/GE

€ 13,90

SERIE CHIAVI ESAGONALI

Con testa a giravite ph o taglio, con manico multiuso utilizzabile sia come impugnatura a t che come estensione della chiave.



Misure	2 - 2,5 - 3 - 4 - 5 - 6 - 8 - 10 mm
Giravite a croce per meccanica	PH0 (3mm) - PH1 (4mm) - PH2 (5mm)
Giravite a taglio per meccanica	6mm

0545/EF

PRO € 32,80

SERIE CHIAVI ESAGONALI COLORATE CON PUNTA SFERICA

DIN 911.



Misure	1.5 - 2 - 2.5 - 3 - 4 - 5 - 6 - 8 - 10 mm
--------	---

0090

€ 2,82

SERIE CHIAVI ESAGONALI

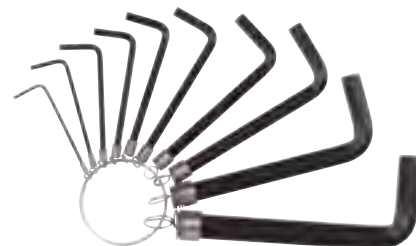

Misure	1,5 - 2 - 2,5 - 3 - 3,5 - 4 - 5 - 6 - 8 - 10 mm
--------	---

0269

€ 5,50

SERIE CHIAVI ESAGONALI

DIN 911.



Misure	1,5 - 2 - 2,5 - 3 - 4 - 5 - 6 - 8 - 10 mm
--------	---

0215X

SERIE CHIAVI ESAGONALI LUNGHE CON PUNTA SFERICA



Art.	€	Misura
0215	€ 11,90	1,5 - 2 - 2,5 - 3 - 4 - 5 - 6 - 8 - 10
0215P	€ 11,90	1/16" - 5/64" - 3/32" - 1/8" - 5/32" - 3/16" - 1/4" - 5/16" - 3/8"

0558/EM **PRO** € 17,50

SERIE CHIAVI ESAGONALI CON PUNTA DIAMANTATA

DIN ISO 2936, la punta diamantata consente una perfetta presa evitando di rovinare la testa della vite. Questa tipologia di punta è anche molto efficace con viti già rovinate.

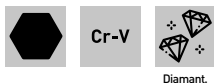
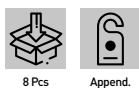

Misure 1,5 - 2 - 2,5 - 3 - 4 - 5 - 6 - 8 mm

0558/EP **PRO** € 17,50

SERIE CHIAVI ESAGONALI CON PUNTA DIAMANTATA

DIN ISO 2936, la punta diamantata consente una perfetta presa evitando di rovinare la testa della vite. Questa tipologia di punta è anche molto efficace con viti già rovinate.

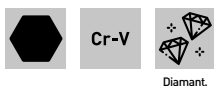
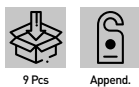

Misure 5/64" - 3/32" - 7/64" - 1/8" - 9/64" - 5/32" - 3/16" - 7/32" - 1/4"

C856- **PRO**

CHIAVI ESAGONALI CON MANICO IN PLASTICA E PUNTA SFERICA

DIN ISO 2936.



Art.	€	Misura	Lunghezza
C856/02.5	€ 4,03	2.5 mm	175 mm
C856/03	€ 4,03	3 mm	175 mm
C856/04	€ 4,23	4 mm	175 mm
C856/05	€ 4,54	5 mm	175 mm
C856/06	€ 6,40	6 mm	175 mm
C856/08	€ 7,00	8 mm	170 mm
C856/10	€ 9,70	10 mm	170 mm

0856-

CHIAVI ESAGONALI CON MANICO ANATOMICO IN PLASTICA E PUNTA SFERICA

DIN 911.

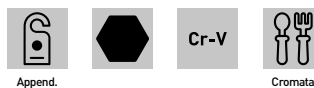

Art.	€	Misura	Lunghezza
0856/02	€ 2,52	2 mm	100 mm
0856/02.5	€ 2,52	2,5 mm	100 mm
0856/03	€ 2,62	3 mm	100 mm
0856/04	€ 2,82	4 mm	100 mm
0856/05	€ 3,93	5 mm	150 mm
0856/06	€ 4,33	6 mm	150 mm
0856/08	€ 6,10	8 mm	200 mm
0856/10	€ 6,30	10 mm	200 mm

0400-

CHIAVI ESAGONALI MASCHIO A "T"

DIN ISO 2936, con asta scorrevole che la rende versatile all'uso in situazioni difficili e in condizioni gravose.

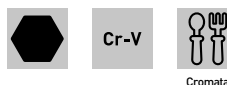

Art.	€	Misura	Dimensioni
0400/02	€ 8,70	2 mm	125 x 65 mm
0400/025	€ 8,70	2,5 mm	125 x 65 mm
0400/03	€ 8,70	3 mm	125 x 65 mm
0400/035	€ 8,70	3,5 mm	125 x 65 mm
0400/04	€ 9,30	4 mm	180 x 90 mm
0400/045	€ 9,30	4,5 mm	180 x 90 mm
0400/05	€ 9,30	5 mm	180 x 90 mm
0400/06	€ 9,80	6 mm	210 x 105 mm
0400/07	€ 9,80	7 mm	250 x 105 mm
0400/08	€ 11,30	8 mm	250 x 125 mm
0400/09	€ 13,70	9 mm	300 x 145 mm
0400/10	€ 13,70	10 mm	300 x 145 mm
0400/12	€ 19,40	12 mm	320 x 165 mm
0400/14	€ 24,80	14 mm	340 x 170 mm



0400

€ 66,50

SERIE CHIAVI ESAGONALI MASCHIO A "T"

DIN ISO 2936, con asta scorrevole che le rende versatili all'uso in situazioni difficili e in condizioni gravose.



7 Pcs



Scatola



Cr-V



Cromata

Misure

2 - 3 - 4 - 5 - 6 - 8 - 10 mm

0220

€ 14,00

SERIE CHIAVI TORX LUNGHE

DIN 911, con foro di guida.



9 Pcs



Blister



Cr-V



Satinata

Misure

T10 - T15 - T20 - T25 - T27 - T30 - T40 - T45 - T50

0545/TF

PRO € 35,30

SERIE CHIAVI TORX COLORATE

DIN 911.



9 Pcs



Blister



Mo-V

Misure

T10 - T15 - T20 - T25 - T27 - T30 - T40 - T45 - T50

0190

PRO € 74,60

SERIE CHIAVI ESAGONALI A T SPEEDY

Con pratica impugnatura girevole "speedy" per una maggiore velocita' di utilizzo



7 Pcs



Scatola



Cr-V



Cromata

Misure

2 - 3 - 4 - 5 - 6 - 8 - 10 mm

0220/C

NEW € 8,60

SERIE CHIAVI TORX CORTE

Con foro di guida



9 Pcs



Cr-V



Cromata

Misure

T10 - T15 - T20 - T25 - T27 - T30 - T40 - T45 - T50

0558/TX

PRO € 17,50

SERIE CHIAVI TORX CON PUNTA DIAMANTATA

DIN ISO 2936, la punta diamantata consente una perfetta presa evitando di rovinare la testa della vite. Questa tipologia di punta è anche molto efficace con viti già rovinate.



8 Pcs



Blister



Cr-V



Diamant.

Misure

T9 - T10 - T15 - T20 - T25 - T27 - T30 - T40

0855-

CHIAVI TORX CON MANICO ANATOMICO IN PLASTICA



Art.	€	Misura	Lunghezza
0855/T10	€ 2,52	T10	100 mm
0855/T15	€ 2,52	T15	100 mm
0855/T20	€ 2,82	T20	100 mm
0855/T25	€ 3,33	T25	100 mm
0855/T30	€ 3,93	T30	150 mm
0855/T40	€ 5,00	T40	150 mm

PRO

C855-

CHIAVI TORX CON MANICO IN PLASTICA

DIN ISO 2936.

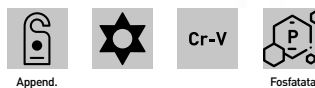

Art.	€	Misura	Lunghezza
C855/T10	€ 4,03	T10	175 mm
C855/T15	€ 4,03	T15	175 mm
C855/T20	€ 4,54	T20	175 mm
C855/T25	€ 5,40	T25	175 mm
C855/T27	€ 5,40	T27	175 mm
C855/T30	€ 6,40	T30	175 mm
C855/T40	€ 8,10	T40	170 mm
C855/T50	€ 9,60	T50	170 mm

0405-

CHIAVE TORX MASCHIO A "T"

DIN ISO 2936, con asta scorrevole che la rende versatile all'uso in situazioni difficili e in condizioni gravose.

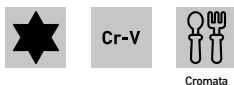

Art.	€	Misura	Lunghezza
0405/T06	€ 9,90	T06	125 mm
0405/T07	€ 9,90	T07	125 mm
0405/T08	€ 9,90	T08	125 mm
0405/T09	€ 9,90	T09	125 mm
0405/T10	€ 9,90	T10	125 mm
0405/T15	€ 9,90	T15	125 mm
0405/T20	€ 9,90	T20	125 mm
0405/T25	€ 10,20	T25	180 mm
0405/T27	€ 10,20	T27	180 mm
0405/T30	€ 10,20	T30	180 mm
0405/T40	€ 12,20	T40	210 mm
0405/T45	€ 13,30	T45	210 mm
0405/T50	€ 14,30	T50	210 mm

0405

€ 67,40

SERIE CHIAVI TORX MASCHIO A "T"

DIN ISO 2936, con asta scorrevole che la rende versatili all'uso in situazioni difficili e in condizioni gravose.



Misure	T8-T9-T10-T15-T20-T25-T30
--------	---------------------------



0359-

CHIAVE CANDELA

DIN 3124.

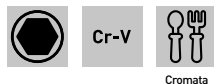

Art.	€	Misura	Lunghezza
0359/14L	€ 23,20	14 mm	530 mm
0359/16L	€ 23,20	16 mm	530 mm
0359/21L	€ 25,20	20,8 mm	530 mm
0359/16	€ 19,10	16 mm	275 mm

007X

CHIAVE PER CANDELA

DIN 899.



Art.	€	Misura	Lunghezza
0078	€ 7,00	20,8	500 mm
0079	€ 7,00	16 mm	510 mm

C395-

CHIAVE A T CON BUSSOLA ESAGONALE SNODATA MAGNETICA

DIN 3124.

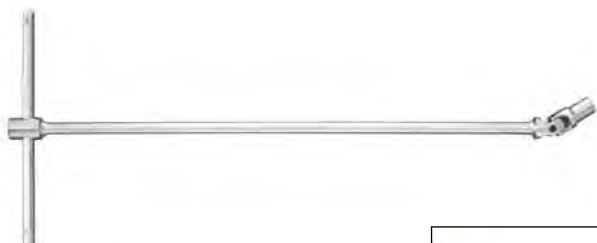

Art.	€	Misura	Lunghezza
C395/06	€ 17,70	6 mm	390 mm
C395/07	€ 17,70	7 mm	390 mm
C395/08	€ 17,70	8 mm	390 mm
C395/09	€ 17,70	9 mm	390 mm
C395/10	€ 20,00	10 mm	500 mm
C395/11	€ 20,00	11 mm	500 mm
C395/12	€ 20,00	12 mm	500 mm
C395/13	€ 20,90	13 mm	500 mm
C395/14	€ 20,90	14 mm	500 mm
C395/15	€ 23,70	15 mm	500 mm
C395/16	€ 23,70	16 mm	500 mm
C395/17	€ 23,70	17 mm	500 mm
C395/18	€ 24,70	18 mm	500 mm
C395/19	€ 26,20	19 mm	500 mm

C245-

CHIAVE A T CON BUSSOLA ESAGONALE PROFONDA

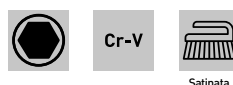

Art.	€	Misura	Lunghezza
C245/06	€ 14,20	6 mm	320 mm
C245/07	€ 14,20	7 mm	320 mm
C245/08	€ 14,20	8 mm	320 mm
C245/09	€ 14,20	9 mm	320 mm
C245/10	€ 14,60	10 mm	320 mm
C245/11	€ 14,60	11 mm	320 mm
C245/12	€ 15,10	12 mm	320 mm
C245/13	€ 15,10	13 mm	320 mm
C245/14	€ 16,10	14 mm	320 mm
C245/17	€ 18,60	17 mm	320 mm
C245/19	€ 23,20	19 mm	320 mm

C391-

CHIAVE A T CON BUSSOLA ESAGONALE SNODATA

PRO

DIN 896, per servizio gravoso.

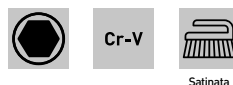

Art.	€	Misura	Lunghezza
C391/06	€ 20,20	6 mm	395 mm
C391/07	€ 20,20	7 mm	395 mm
C391/08	€ 20,20	8 mm	395 mm
C391/09	€ 20,20	9 mm	400 mm
C391/10	€ 22,10	10 mm	400 mm
C391/11	€ 22,10	11 mm	400 mm
C391/12	€ 22,10	12 mm	400 mm
C391/13	€ 24,20	13 mm	432 mm
C391/14	€ 24,20	14 mm	432 mm
C391/15	€ 29,30	15 mm	450 mm
C391/16	€ 29,30	16 mm	450 mm
C391/17	€ 29,30	17 mm	450 mm
C391/18	€ 29,30	18 mm	450 mm
C391/19	€ 32,30	19 mm	500 mm

0352-

CHIAVE FILTRO A NASTRO



Art.	€	Diametro massimo filtro	Nastro
0352/01	€ 20,00	180 mm	610 mm
0352/02	€ 21,70	220 mm	800 mm

0076

€ 4,54

CHIAVE FILTRO A NASTRO

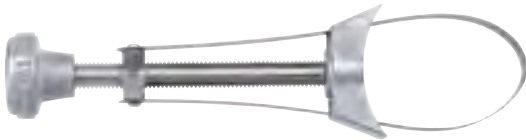

Diametro massimo filtro	120 mm
Nastro	195 mm

0018/15

€ 64,40

SERIE CHIAVI PER FILTRI OLIO

Utili per lo smontaggio dei filtri dell'olio di molte autovetture. adattatore da 3/8" maschio e 1/2" femmina incluso nel set.



Misure (ø mm - lati)	Attacco adattatore
65 mm - 14, 65/67 mm - 14, 68 mm - 14, 74 mm - 15, 74/76 mm - 15, 75/77 mm - 15, 76 mm - 14, 76 mm - 30, 80 mm - 15, 80/82 mm	1/2" (F) 3/8" (M)

0357-

PRO

CHIAVE PER FILTRO A NASTRO REGOLABILE IN ACCIAIO

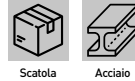

Art.	€	Diametro massimo filtro	Nastro
0357/01	€ 23,00	70 mm	180 mm
0357/02	€ 25,00	120 mm	200 mm

0077

€ 6,10

CHIAVE FILTRO A CATENA



Diametro massimo filtro	110 mm
Nastro	380 mm

0018/30

€ 143,00

SERIE CHIAVI PER FILTRI OLIO

Utili per lo smontaggio dei filtri dell'olio di molte autovetture. adattatore da 3/8" maschio e 1/2" femmina e chiave a 3 griffe inclusi nel set.



Misure (ø mm - lati)	Attacco adattatore	Chiave a 3 griffe
65 mm - 14, 65/67 mm - 14, 66 mm - 6, 68 mm - 14, 73 mm - 14, 74 mm - 15, 74/76 mm - 15, 75/77 mm - 15, 76 mm - 8, 76 mm - 12, 76 mm - 14, 76 mm - 30, 78 mm - 15, 80 mm - 15, 80/82 mm - 15, 86 mm - 16, 86 mm - 18, 90 mm - 15, 92 mm - 10, 93 mm - 15, 93 mm - 36, 93 mm	1/2" (F) 3/8" (M)	65 ÷ 120 mm



0080 € 9,30

CHIAVE A CROCE

DIN 899.



Misure	17 - 19 - 21 mm
Dimensioni	381 x 16 mm

0426-

CHIAVE A CROCE

Per autocarro, con bussole fisse esagonali



Art.	€	Misure	Dimensioni
0426/30	€ 33,60	24 - 27 - 30 mm	550 x 20 mm
0426/32	€ 42,60	24 - 27 - 32 mm	700 x 22 mm

0451

PRO € 35,90

CHIAVE A CROCE SMONTABILE

Composta da 2 bussole esagonali a 4 misure, leva e manico rotante.

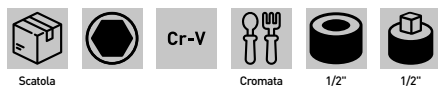

Misure bussole	17 - 19 - 21 - 23 mm
Dimensioni leva	ø15 x 400 mm
Lunghezza manico	330 mm



0806/200

€ 445,00

CHIAVE DINAMOMETRICA ELETTRONICA DIGITALE, LETTURA DI COPPIA E ANGOLO

Permette serraggi in senso orario e antiorario e una diagnostica luminosa e sonora dello stato coppia/angolo.

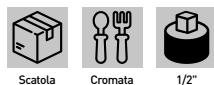

SCALE DI MISURAZIONE:	Nm / kgm / lbf-ft / lbf-in	Precisione angolo	±1%
Capacità	20 ÷ 200 Nm	Modalità operativa	Peak / Track
Letture	0,1 Nm	Memorie coppia - angolo	5
Precisione	±2%, 10% @ 200 Nm	Lunghezza	605 mm
Angolo di misurazione	0 ÷ 360°	Batteria	4x 1,5 V AAA

0809-

PRO

CHIAVE DINAMOMETRICA ELETTRONICA DIGITALE

Permette serraggi in senso orario e antiorario e una diagnostica luminosa e sonora dello stato della coppia.



Art.	€	SCALE DI MISURAZIONE:	Capacità	Letture	Precisione	Modalità operativa	Memorie	Attacco quadro	Lunghezza	Batteria
0809/030	€ 106,00	Nm / kgf-cm / lbf-ft / lbf-in	6 ÷ 30 Nm	0,01 Nm	±4%	Peak / Track	50	1/4"	200 mm	2 x 3 V CR2032
0809/080	€ 113,00	Nm / kgf-m / lbf-ft / lbf-in	16 ÷ 80 Nm	0,1 Nm	±3%	Peak / Track	50	3/8"	230 mm	2 x 3 V CR2032
0809/100	€ 119,00	Nm / kgf-m / lbf-ft / lbf-in	20 ÷ 100 Nm	0,1 Nm	±2%	Peak / Track	50	1/2"	275 mm	2 x 3 V CR2032

0806/020 € 109,00

CACCIAVITE DINAMOMETRICO DIGITALE

ISO 6789-2017, serraggio in senso orario ed antiorario, diagnostica sonora e a vibrazione della coppia raggiunta preimpostata.



SCALE DI MISURAZIONE:	Nm / lbft / lbin
Capacità	0 ÷ 20 Nm
Lettura	0,01 Nm
Precisione	±2%
Modalità operativa	Peak / Track
Autospegnimento	5 min.
Lunghezza	175 mm
Batteria	2 x 1,5 V AAA
Temperatura di esercizio	0 °C - 40 °C
Temperatura stoccaggio	-5 °C - 45 °C

0268A **NEW** € 97,50

MISURATORE DIGITALE DI COPPIA

Strumento di monitoraggio della torsione. Applicato ad una chiave a cricco può essere usato come chiave dinamometrica. Schermo LCD retroilluminato, modalità operativa Picco e Traccia. Funzione di autospegnimento



Modalità operativa	Picco/traccia
SCALE DI MISURAZIONE:	Nm/kgm/kgcm/lbft/lbin
Capacità	40 ÷ 200 Nm
Lettura	0,1 Nm
Memorie	50
Precisione	±2%
Dimensioni	75 x 44mm
Batteria	2 x AAA
Temperatura di esercizio	-10°C - 60 °C (14°F - 139.9 °F)
Temperatura stoccaggio	-20°C - 70°C (-4 °F - 157.9°F)

0137 € 61,00

CHIAVE DINAMOMETRICA



Capacità	28 ÷ 210 Nm
Prolunga	120 mm



0815- **PRO NEW**

CHIAVI DINAMOMETRICHE

ISO 6789-2017, finestra di lettura.



Art.	€	Attacco quadro	Capacità	Risoluzione	Precisione	Lunghezza
0815/100	€ 161,00	3/8"	20 ÷ 100 Nm	0,5 Nm	±4%	460 mm
0815/200	€ 212,00	1/2"	40 ÷ 200 Nm	1,0 Nm	±4%	515 mm
0815/320	€ 231,00	1/2"	60 ÷ 320 Nm	2,0 Nm	±4%	585 mm
0815/800	€ 735,00	3/4"	100 ÷ 800 Nm	5,0 Nm	±4%	1100 mm



0803-

CHIAVI DINAMOMETRICHE

ISO 6789-2017.



Valigetta



Satinata

Art.	€	Attacco	Capacità	Risoluzione	Precisione	Lunghezza
0803/110	€ 138,00	3/8"	20 - 110 Nm	0,5 Nm	±4%	380 mm
0803/210	€ 198,00	1/2"	40 - 210 Nm	1 Nm	±4%	535 mm
0803/700	€ 645,00	3/4"	140 - 700 Nm	2,5 Nm	±4%	1085 mm

0803/S210

€ 317,00

CHIAVE DINAMOMETRICA IN SET

ISO 6789-2017.



11 Pcs



Valigetta



Satinata

Attacco chiavi	14 x 18 mm
Testa reversibile	1/2"
Capacità	40 ÷ 210 Nm
Precisione	±4%
Risoluzione	1 Nm
Chiavi	13 - 14 - 15 - 17 - 19 - 22 - 24 - 27 - 30 mm

0803/S080

€ 215,00

CHIAVE DINAMOMETRICA IN SET

ISO 6789-2017.



8 Pcs



Valigetta



Satinata

Attacco chiavi	14x 18 mm
Testa reversibile	3/8"
Capacità	15 ÷ 80 Nm
Precisione	±4%
Chiavi	17 - 22 - 24 - 26 - 27 - 30 mm
Risoluzione	0,5 Nm

0329

€ 171,00

MOLTIPLICATORE DI FORZA

DIN 3113, smontaruote per autocarro.



7 Pcs



Valigetta



1"

Bussole da 1"	32 - 33 mm
Rapporto	1:60
Forza massima	3200 Nm
Forza di lavoro	1200 Nm
Peso netto	7,5 kg

0360

€ 77,70

MOLTIPLICATORE DI FORZA

DIN 3113, smontaruote per autocarro, fornito in valigetta di plastica.



7 Pcs



Valigetta



1"

Bussole da 1"	32 - 33 mm
Rapporto	1 : 56
Forza massima	3000 Nm
Forza di lavoro	1000 Nm
Peso netto	7 kg

CN450N0/0 € 46,60
CRICCHETTO REVERSIBILE A CAMBIO RAPIDO 3 IN 1

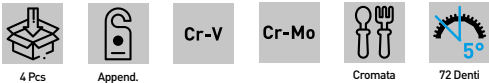

Lunghezza	230 mm
Attacco	1/2" - 3/8" - 1/4"
Denti	72

G090- **PRO**
CRICCHETTO ERGONOMICO

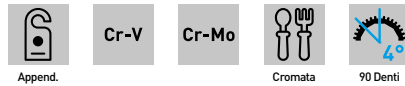

Art.	€	Lunghezza	Attacco quadro
G090/1/4	€ 21,50	145 mm	1/4"
G090/3/8	€ 26,10	195 mm	3/8"
G090/1/2	€ 29,80	265 mm	1/2"

F090- **PRO**
CRICCHETTO ERGONOMICO

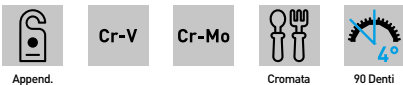

Art.	€	Lunghezza	Attacco quadro
F090/1/4	€ 21,50	145 mm	1/4"
F090/3/8	€ 26,10	195 mm	3/8"
F090/1/2	€ 29,80	265 mm	1/2"

0494- **PRO**
CRICCHETTO ERGONOMICO CON TESTA ANTISPORCO

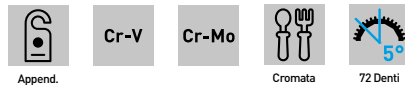

Art.	€	Lunghezza	Attacco quadro
0494/1/4	€ 26,10	165 mm	1/4"
0494/3/8	€ 29,80	215 mm	3/8"
0494/1/2	€ 35,90	276 mm	1/2"

CN450NX
CRICCHETTO ERGONOMICO

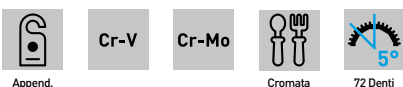

Art.	€	Lunghezza	Attacco quadro
CN450N1/4A	€ 26,00	150 mm	1/4"
CN450N3/8A	€ 30,10	205 mm	3/8"
CN450N1/2A	€ 31,10	250 mm	1/2"

0439-
CRICCHETTO ERGONOMICO

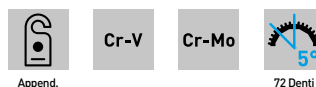

Art.	€	Attacco quadro	Lunghezza	Denti
0439/1/4	€ 17,80	1/4"	155 mm	72
0439/3/8	€ 25,10	3/8"	200 mm	72
0439/1/2	€ 30,10	1/2"	260 mm	72



0019-

LEVA A CRICCO REVERSIBILE CON ESTRATTORE



Cr-V

Cr-Mo



90 Denti

Art.	€	Lunghezza	Attacco quadro
0019/1/4	€ 15,70	154 mm	1/4"
0019/3/8	€ 22,50	215 mm	3/8"
0019/1/2	€ 28,60	275 mm	1/2"

0308

€ 35,80

CRICCHETTO REVERSIBILE



Cr-V



45 Denti



Lunghezza

490 mm

0228

€ 11,10

CRICCHETTO REVERSIBILE



Cr-V



39 Denti



Lunghezza

250 mm

0173

€ 4,76

IMPUGNATURA PER BUSSOLE DA 1/4"

Con attacco quadro femmina da 1/4" per essere utilizzata anche come prolunga



Cr-V



Lunghezza



BN4E5NX

CHIAVE A BUSSOLA ESAGONALE, SERIE NORMALE

DIN 3124.

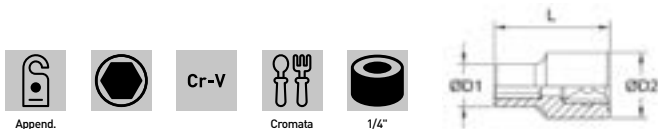

Art.	€	Misura	D1	D2	Lunghezza
BN4E5N004A	€ 1,49	4 mm	6,8 mm	12 mm	25 mm
BN4E5N0045A	€ 1,49	4,5 mm	7,2 mm	12 mm	25 mm
BN4E5N005A	€ 1,49	5 mm	7,8 mm	12 mm	25 mm
BN4E5N0055A	€ 1,49	5,5 mm	8,4 mm	12 mm	25 mm
BN4E5N006A	€ 1,49	6 mm	9,3 mm	12 mm	25 mm
BN4E5N007A	€ 1,49	7 mm	10,8 mm	12 mm	25 mm
BN4E5N008A	€ 1,72	8 mm	12 mm	11 mm	25 mm
BN4E5N009A	€ 1,72	9 mm	13 mm	12 mm	25 mm
BN4E5N010A	€ 1,72	10 mm	14,6 mm	12 mm	25 mm
BN4E5N011A	€ 1,93	11 mm	16 mm	12,5 mm	25 mm
BN4E5N012A	€ 1,93	12 mm	17 mm	13,5 mm	25 mm
BN4E5N013A	€ 2,13	13 mm	18 mm	13,5 mm	25 mm
BN4E5N014A	€ 2,35	14 mm	19 mm	14,5 mm	25 mm

BN4E5LX

CHIAVE A BUSSOLA ESAGONALE LUNGA

DIN 3124.

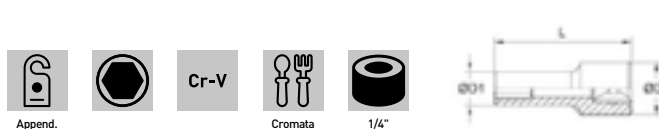

Art.	€	Misura	D1	D2	Lunghezza
BN4E5L004A	€ 3,53	4 mm	6,8 mm	12 mm	50 mm
BN4E5L0045A	€ 3,53	4,5 mm	7,2 mm	12 mm	50 mm
BN4E5L005A	€ 3,53	5 mm	7,8 mm	12 mm	50 mm
BN4E5L0055A	€ 3,53	5,5 mm	8,4 mm	12 mm	50 mm
BN4E5L006A	€ 3,53	6 mm	9,3 mm	12 mm	50 mm
BN4E5L007A	€ 3,53	7 mm	10,8 mm	12 mm	50 mm
BN4E5L008A	€ 3,53	8 mm	12 mm	11 mm	50 mm
BN4E5L009A	€ 3,53	9 mm	13 mm	12 mm	50 mm
BN4E5L010A	€ 3,53	10 mm	14,6 mm	12 mm	50 mm
BN4E5L011A	€ 3,84	11 mm	16 mm	13 mm	50 mm
BN4E5L012A	€ 3,84	12 mm	17 mm	13 mm	50 mm
BN4E5L013A	€ 4,05	13 mm	18 mm	13 mm	50 mm
BN4E5L014A	€ 4,05	14 mm	19 mm	14,5 mm	50 mm

BN4P5NX

CHIAVE A BUSSOLA POLIGONALE, SERIE NORMALE

DIN 3124.

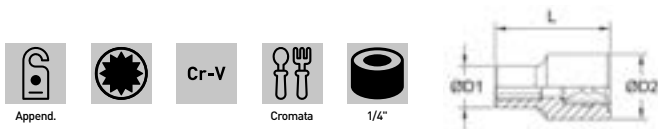

Art.	€	Misura	D1	D2	Lunghezza
BN4P5N004A	€ 1,41	4 mm	6,8 mm	12 mm	25 mm
BN4P5N005A	€ 1,41	5 mm	7,8 mm	12 mm	25 mm
BN4P5N0055A	€ 1,41	5,5 mm	8,4 mm	12 mm	25 mm
BN4P5N006A	€ 1,41	6 mm	9,3 mm	12 mm	25 mm
BN4P5N007A	€ 1,41	7 mm	10,8 mm	12 mm	25 mm
BN4P5N008A	€ 1,60	8 mm	12 mm	11 mm	25 mm
BN4P5N009A	€ 1,60	9 mm	13 mm	12 mm	25 mm
BN4P5N010A	€ 1,60	10 mm	14,6 mm	12 mm	25 mm
BN4P5N011A	€ 1,82	11 mm	16 mm	12,5 mm	25 mm
BN4P5N012A	€ 1,82	12 mm	17 mm	13,5 mm	25 mm
BN4P5N013A	€ 2,04	13 mm	18 mm	13,5 mm	25 mm
BN4P5N014A	€ 2,13	14 mm	19 mm	14,5 mm	25 mm

BN415NX

BUSSOLA CON INSERTO ESAGONALE



Art.	€	Misura	D2	Lunghezza
BN415N003A	€ 2,68	3 mm	12 mm	37 mm
BN415N004A	€ 2,68	4 mm	12 mm	37 mm
BN415N005A	€ 2,68	5 mm	12 mm	37 mm
BN415N006A	€ 2,68	6 mm	12 mm	37 mm
BN415N008A	€ 2,68	8 mm	12 mm	37 mm



BN425NX

BUSSOLA CON INSERTO TORX

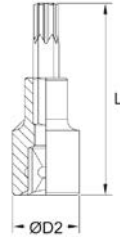

Art.	€	Misura	D2	Lunghezza
BN425N008A	€ 2,68	T8	12 mm	37 mm
BN425N009A	€ 2,68	T9	12 mm	37 mm
BN425N010A	€ 2,68	T10	12 mm	37 mm
BN425N015A	€ 2,68	T15	12 mm	37 mm
BN425N020A	€ 2,68	T20	12 mm	37 mm
BN425N025A	€ 2,68	T20	12 mm	37 mm
BN425N027A	€ 2,68	T27	12 mm	37 mm
BN425N030A	€ 2,68	T30	12 mm	37 mm
BN425N040A	€ 2,68	T40	12 mm	37 mm

RN4054NA

€ 3,20

RACCORDO



Lunghezza 26 mm

PN405NX

PROLUNGA

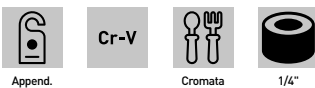

Art.	€	Lunghezza
PN405N050A	€ 3,20	50 mm
PN405N075A	€ 3,42	75 mm
PN405N150A	€ 5,10	150 mm

LN400N1/4A

€ 4,85

LEVA A T SCORREVOLE



Lunghezza 115 mm



BN445NX

BUSSOLA CON INSERTO XZN

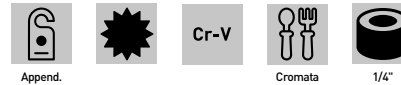
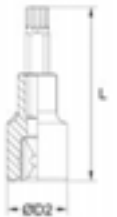

Art.	€	Misura	D2	Lunghezza
BN445N004A	€ 9,00	M 4	15 mm	37 mm
BN445N005A	€ 9,00	M 5	15 mm	37 mm
BN445N006A	€ 9,00	M 6	15 mm	37 mm
BN445N008A	€ 9,00	M 8	15 mm	37 mm
BN445N009A	€ 9,00	M 9	15 mm	37 mm
BN445N010A	€ 9,00	M 10	15 mm	37 mm

JN405NA

€ 5,80

SNODO A CARDANO

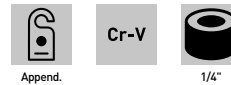

Lunghezza 38 mm

EN405NX

PROLUNGA A TESTA SFERICA

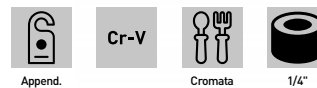

Art.	€	Lunghezza
EN405N050A	€ 4,25	50 mm
EN405N075A	€ 4,85	75 mm
EN405N150A	€ 5,30	150 mm

BN4E4NX

CHIAVE A BUSSOLA ESAGONALE, SERIE NORMALE

DIN 3124.



Art.	€	Misura	D1	D2	Lunghezza
BN4E4N006A	€ 2,56	6 mm	9,3 mm	17 mm	28 mm
BN4E4N007A	€ 2,56	7 mm	10,6 mm	17 mm	28 mm
BN4E4N008A	€ 2,56	8 mm	11,8 mm	17 mm	28 mm
BN4E4N009A	€ 2,56	9 mm	13,2 mm	17 mm	28 mm
BN4E4N010A	€ 2,56	10 mm	14,5 mm	17 mm	28 mm
BN4E4N011A	€ 2,56	10 mm	15,7 mm	17 mm	28 mm
BN4E4N012A	€ 2,56	12 mm	17 mm	16,4 mm	28 mm
BN4E4N013A	€ 2,56	13 mm	18 mm	17 mm	28 mm
BN4E4N014A	€ 3,20	14 mm	20 mm	17 mm	28 mm
BN4E4N015A	€ 3,20	15 mm	20,9 mm	18 mm	28 mm
BN4E4N016A	€ 3,20	16 mm	22 mm	18 mm	28 mm
BN4E4N017A	€ 3,20	17 mm	24 mm	18 mm	30 mm
BN4E4N018A	€ 3,84	18 mm	26 mm	18 mm	30 mm
BN4E4N019A	€ 4,05	19 mm	26 mm	20 mm	30 mm
BN4E4N020A	€ 4,76	20 mm	27,1 mm	20 mm	30 mm
BN4E4N021A	€ 4,76	21 mm	28 mm	20 mm	30 mm
BN4E4N022A	€ 5,60	22 mm	30 mm	20 mm	32 mm

BN4E4LX

CHIAVE A BUSSOLA ESAGONALE LUNGA

DIN 3124.



Art.	€	Misura	D1	D2	Lunghezza
BN4E4L006A	€ 5,60	6 mm	9,3 mm	17 mm	63 mm
BN4E4L007A	€ 5,60	7 mm	10,6 mm	17 mm	62 mm
BN4E4L008A	€ 5,60	8 mm	11,8 mm	17 mm	63 mm
BN4E4L009A	€ 5,60	9 mm	13,2 mm	17 mm	63 mm
BN4E4L010A	€ 5,60	10 mm	14,5 mm	17 mm	63 mm
BN4E4L011A	€ 5,60	11 mm	15,7 mm	17 mm	63 mm
BN4E4L012A	€ 5,60	12 mm	17 mm	16,4 mm	63 mm
BN4E4L013A	€ 5,60	13 mm	18 mm	17 mm	63 mm
BN4E4L014A	€ 6,30	14 mm	19,6 mm	17 mm	63 mm
BN4E4L015A	€ 6,30	15 mm	20,9 mm	18 mm	63 mm
BN4E4L016A	€ 6,30	16 mm	22 mm	18 mm	63 mm
BN4E4L017A	€ 6,30	17 mm	23,4 mm	18 mm	63 mm
BN4E4L018A	€ 7,30	18 mm	24,6 mm	20 mm	63 mm
BN4E4L019A	€ 7,30	19 mm	26 mm	20 mm	63 mm
BN4E4L020A	€ 7,30	20 mm	27,1 mm	20 mm	63 mm
BN4E4L021A	€ 8,60	21 mm	28 mm	20 mm	63 mm
BN4E4L022A	€ 8,60	22 mm	30 mm	20 mm	63 mm

BN4P4NX

CHIAVE A BUSSOLA POLIGONALE, SERIE NORMALE

DIN 3125.



Art.	€	Misura	D1	D2	Lunghezza
BN4P4N006A	€ 2,35	6 mm	9,3 mm	17 mm	28 mm
BN4P4N007A	€ 2,35	7 mm	10,6 mm	17 mm	28 mm
BN4P4N008A	€ 2,35	8 mm	11,8 mm	17 mm	28 mm
BN4P4N009A	€ 2,35	9 mm	13,2 mm	17 mm	28 mm
BN4P4N010A	€ 2,35	10 mm	14,5 mm	17 mm	28 mm
BN4P4N011A	€ 2,35	11 mm	15,7 mm	17 mm	28 mm
BN4P4N012A	€ 2,35	12 mm	17 mm	16,4 mm	28 mm
BN4P4N013A	€ 2,35	13 mm	18 mm	17 mm	28 mm
BN4P4N014A	€ 2,99	14 mm	20 mm	17 mm	28 mm
BN4P4N015A	€ 2,99	15 mm	20,9 mm	18 mm	28 mm
BN4P4N016A	€ 2,99	16 mm	22 mm	18 mm	28 mm
BN4P4N017A	€ 2,99	17 mm	24 mm	18 mm	30 mm
BN4P4N018A	€ 3,62	18 mm	26 mm	18 mm	30 mm
BN4P4N019A	€ 3,84	19 mm	26 mm	20 mm	30 mm
BN4P4N020A	€ 4,36	20 mm	28 mm	20 mm	30 mm
BN4P4N021A	€ 4,36	21 mm	28 mm	20 mm	30 mm
BN4P4N022A	€ 5,20	22 mm	30 mm	20 mm	32 mm





BN414NX

BUSSOLA CON INSERTO ESAGONALE



Art.	€	Misura	D2	Lunghezza
BN414N003A	€ 6,10	3 mm	18 mm	48 mm
BN414N004A	€ 6,10	4 mm	18 mm	48 mm
BN414N005A	€ 6,10	5 mm	18 mm	48 mm
BN414N006A	€ 6,10	6 mm	18 mm	48 mm
BN414N007A	€ 6,10	7 mm	18 mm	48 mm
BN414N008A	€ 6,10	8 mm	18 mm	48 mm
BN414N009A	€ 6,10	9 mm	20 mm	48 mm
BN414N010A	€ 6,10	10 mm	20 mm	48 mm
BN414N012A	€ 6,20	12 mm	20 mm	48 mm

BN414LX

BUSSOLA CON INSERTO ESAGONALE LUNGO

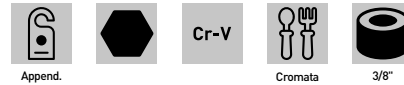

Art.	€	Misura	D2	Lunghezza
BN414L003A	€ 8,80	3 mm	18 mm	95 mm
BN414L004A	€ 8,80	4 mm	18 mm	95 mm
BN414L005A	€ 8,80	5 mm	18 mm	95 mm
BN414L006A	€ 8,80	6 mm	18 mm	95 mm
BN414L007A	€ 9,00	7 mm	18 mm	95 mm
BN414L008A	€ 9,00	8 mm	18 mm	95 mm
BN414L009A	€ 9,00	9 mm	20 mm	95 mm
BN414L010A	€ 9,00	10 mm	20 mm	95 mm
BN414L012A	€ 10,20	12 mm	20 mm	95 mm

BN424NX

BUSSOLA CON INSERTO TORX

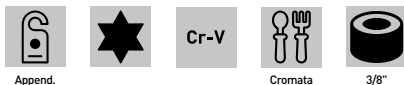

Art.	€	Misura	D2	Lunghezza
BN424N010A	€ 6,50	T10	18 mm	48 mm
BN424N015A	€ 6,50	T15	18 mm	48 mm
BN424N020A	€ 6,50	T20	18 mm	48 mm
BN424N025A	€ 6,50	T25	18 mm	48 mm
BN424N027A	€ 6,50	T27	18 mm	48 mm
BN424N030A	€ 6,50	T30	18 mm	48 mm
BN424N040A	€ 6,50	T40	18 mm	48 mm
BN424N045A	€ 6,50	T45	18 mm	48 mm
BN424N050A	€ 7,30	T50	20 mm	48 mm
BN424N055A	€ 8,60	T55	20 mm	48 mm

BN424LX

BUSSOLA CON INSERTO TORX LUNGO

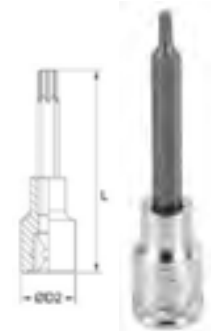
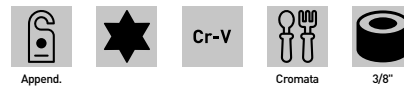

Art.	€	Misura	D2	Lunghezza
BN424L015A	€ 10,70	T15	18 mm	95 mm
BN424L020A	€ 10,70	T20	18 mm	95 mm
BN424L025A	€ 10,70	T25	18 mm	95 mm
BN424L027A	€ 10,70	T27	18 mm	95 mm
BN424L030A	€ 10,70	T30	18 mm	95 mm
BN424L040A	€ 10,70	T40	18 mm	95 mm
BN424L045A	€ 14,30	T45	18 mm	95 mm

BN434NX

BUSSOLA CON INSERTO RIBE



Art.	€	Misura	D2	Lunghezza
BN434N004A	€ 13,70	M 4	18 mm	50 mm
BN434N005A	€ 13,90	M 5	18 mm	50 mm
BN434N006A	€ 14,20	M 6	18 mm	50 mm
BN434N007A	€ 14,40	M 7	18 mm	50 mm
BN434N008A	€ 14,70	M 8	18 mm	50 mm
BN434N009A	€ 15,30	M 9	18 mm	50 mm
BN434N010A	€ 16,70	M 10	20 mm	50 mm

BN434LX

BUSSOLA CON INSERTO RIBE LUNGO

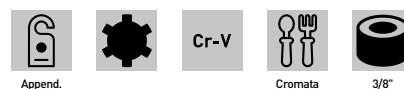

Art.	€	Misura	D2	Lunghezza
BN434L004A	€ 14,70	M 4	18 mm	95 mm
BN434L005A	€ 14,90	M 5	18 mm	95 mm
BN434L006A	€ 15,20	M 6	18 mm	95 mm
BN434L007A	€ 15,20	M 7	18 mm	95 mm
BN434L008A	€ 16,00	M 8	18 mm	95 mm
BN434L009A	€ 16,00	M 9	18 mm	95 mm
BN434L010A	€ 19,70	M 10	20 mm	95 mm

BN444NX

BUSSOLA CON INSERTO XZN



Art.	€	Misura	D2	Lunghezza
BN444N004A	€ 10,70	M 4	18 mm	48 mm
BN444N005A	€ 10,70	M 5	18 mm	48 mm
BN444N006A	€ 10,70	M 6	18 mm	48 mm
BN444N008A	€ 10,70	M 8	18 mm	48 mm
BN444N009A	€ 10,70	M 9	20 mm	48 mm
BN444N010A	€ 10,70	M 10	20 mm	48 mm
BN444N012A	€ 11,30	M 12	20 mm	48 mm
BN444N014A	€ 12,10	M 14	20 mm	48 mm

BN444LX

BUSSOLA CON INSERTO XZN LUNGO



Art.	€	Misura	D2	Lunghezza
BN444L004A	€ 11,70	M 4	18 mm	95 mm
BN444L005A	€ 11,70	M 5	18 mm	95 mm
BN444L006A	€ 11,70	M 6	18 mm	95 mm
BN444L008A	€ 11,70	M 8	18 mm	95 mm
BN444L009A	€ 11,70	M 9	20 mm	95 mm
BN444L010A	€ 12,10	M 10	20 mm	95 mm
BN444L012A	€ 12,90	M 12	20 mm	95 mm
BN444L014A	€ 13,80	M 14	20 mm	95 mm

BN4C4LX

CHIAVE A BUSSOLA PER CANDELA



Art.	€	Misura	Lunghezza
BN4C4L016A	€ 5,30	16 mm	63 mm
BN4C4L018A	€ 7,50	18 mm	63 mm
BN4C4L021A	€ 8,10	21 mm	65 mm



LN400N3/8A

€ 9,30

LEVA A T SCORREVOLE



Lunghezza 200 mm



RN4045NA

€ 3,20

RACCORDO



Lunghezza 27 mm



RN4043NA

€ 3,73

RACCORDO



Lunghezza 35 mm



JN404NA

€ 7,30

SNODO A CARDANO

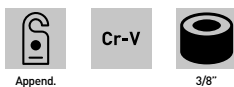

Lunghezza 54 mm



EN404NX

PROLUNGA A TESTA SFERICA

PN404NX

PROLUNGA

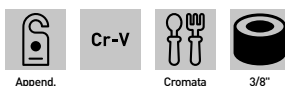

Art.	€	Lunghezza
PN404N050A	€ 3,62	50 mm
PN404N075A	€ 4,95	75 mm
PN404N150A	€ 6,00	150 mm

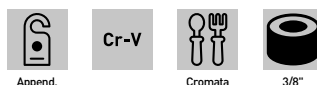

Art.	€	Lunghezza
EN404N038A	€ 4,25	38 mm
EN404N075A	€ 5,30	75 mm
EN404N150A	€ 6,50	150 mm
EN404N250A	€ 10,50	250 mm





BN4E3NX

CHIAVE A BUSSOLA ESAGONALE, SERIE NORMALE

DIN 3124.



Art.	€	Misura	D1	D2	Lunghezza
BN4E3N008A	€ 3,20	8 mm	12,2 mm	22 mm	38 mm
BN4E3N009A	€ 3,20	9 mm	13,5 mm	22 mm	38 mm
BN4E3N010A	€ 3,20	10 mm	15 mm	22 mm	38 mm
BN4E3N011A	€ 3,20	11 mm	16,3 mm	22 mm	38 mm
BN4E3N012A	€ 3,20	12 mm	17,6 mm	22 mm	38 mm
BN4E3N013A	€ 3,20	13 mm	18,8 mm	22 mm	38 mm
BN4E3N014A	€ 3,20	14 mm	20,4 mm	22 mm	38 mm
BN4E3N015A	€ 3,31	15 mm	21 mm	22 mm	38 mm
BN4E3N016A	€ 3,59	16 mm	22 mm	20,5 mm	38 mm
BN4E3N017A	€ 3,84	17 mm	24 mm	22 mm	38 mm
BN4E3N018A	€ 4,16	18 mm	25,4 mm	22 mm	38 mm
BN4E3N019A	€ 4,16	19 mm	26 mm	22 mm	38 mm
BN4E3N020A	€ 4,44	20 mm	28 mm	22 mm	38 mm
BN4E3N021A	€ 4,65	21 mm	28 mm	22 mm	38 mm
BN4E3N022A	€ 5,20	22 mm	30 mm	26 mm	38 mm
BN4E3N023A	€ 5,30	23 mm	31,6 mm	26 mm	38 mm
BN4E3N024A	€ 5,30	24 mm	32 mm	26 mm	38 mm
BN4E3N025A	€ 5,90	25 mm	34 mm	26 mm	42 mm
BN4E3N026A	€ 6,00	26 mm	35,4 mm	28 mm	42 mm
BN4E3N027A	€ 6,00	27 mm	36 mm	28 mm	42 mm
BN4E3N028A	€ 6,30	28 mm	38 mm	28 mm	42 mm
BN4E3N029A	€ 6,60	29 mm	38 mm	28 mm	43 mm
BN4E3N030A	€ 6,60	30 mm	40 mm	28 mm	43 mm
BN4E3N032A	€ 6,60	32 mm	42 mm	28 mm	44 mm

BN4E3LX

CHIAVE A BUSSOLA ESAGONALE LUNGA

DIN 3124.



Art.	€	Misura	D1	D2	Lunghezza
BN4E3L010A	€ 7,00	10 mm	15 mm	22 mm	77 mm
BN4E3L011A	€ 7,00	11 mm	16,3 mm	22 mm	77 mm
BN4E3L012A	€ 7,00	12 mm	17,6 mm	22 mm	77 mm
BN4E3L013A	€ 7,00	13 mm	18,8 mm	22 mm	77 mm
BN4E3L014A	€ 7,30	14 mm	20,4 mm	22 mm	77 mm
BN4E3L015A	€ 7,30	15 mm	21 mm	22 mm	77 mm
BN4E3L016A	€ 7,30	16 mm	22 mm	20,5 mm	77 mm
BN4E3L017A	€ 7,50	17 mm	24 mm	22 mm	77 mm
BN4E3L018A	€ 8,10	18 mm	25,4 mm	22 mm	77 mm
BN4E3L019A	€ 8,10	19 mm	26 mm	22 mm	77 mm
BN4E3L020A	€ 8,50	20 mm	28 mm	22 mm	77 mm
BN4E3L021A	€ 8,80	21 mm	28 mm	22 mm	77 mm
BN4E3L022A	€ 8,80	22 mm	30 mm	26 mm	77 mm
BN4E3L023A	€ 10,60	23 mm	31,6 mm	26 mm	77 mm
BN4E3L024A	€ 11,10	24 mm	32 mm	26 mm	77 mm
BN4E3L027A	€ 15,50	27 mm	36 mm	28 mm	77 mm
BN4E3L030A	€ 16,80	30 mm	40 mm	28 mm	77 mm
BN4E3L032A	€ 16,80	32 mm	42 mm	28 mm	77 mm

BN4P3NX

CHIAVE A BUSSOLA POLIGONALE, SERIE NORMALE

DIN 3124.



Art.	€	Misura	D1	D2	Lunghezza
BN4P3N008A	€ 2,99	8 mm	12,2 mm	22 mm	38 mm
BN4P3N009A	€ 2,99	9 mm	13,5 mm	22 mm	38 mm
BN4P3N010A	€ 2,99	10 mm	15 mm	22 mm	38 mm
BN4P3N011A	€ 2,99	11 mm	16,3 mm	22 mm	38 mm
BN4P3N012A	€ 2,99	12 mm	17,6 mm	22 mm	38 mm
BN4P3N013A	€ 2,99	13 mm	18,8 mm	22 mm	38 mm
BN4P3N014A	€ 2,99	14 mm	20,4 mm	22 mm	38 mm
BN4P3N015A	€ 3,10	15 mm	21 mm	22 mm	38 mm
BN4P3N016A	€ 3,31	16 mm	22 mm	20,5 mm	38 mm
BN4P3N017A	€ 3,62	17 mm	24 mm	22 mm	38 mm
BN4P3N018A	€ 3,94	18 mm	25,4 mm	22 mm	38 mm
BN4P3N019A	€ 3,94	19 mm	26 mm	22 mm	38 mm
BN4P3N020A	€ 4,16	20 mm	28 mm	22 mm	38 mm
BN4P3N021A	€ 4,36	21 mm	28 mm	22 mm	38 mm
BN4P3N022A	€ 4,95	22 mm	30 mm	26 mm	38 mm
BN4P3N023A	€ 5,00	23 mm	31,6 mm	26 mm	38 mm
BN4P3N024A	€ 5,00	24 mm	32 mm	26 mm	38 mm
BN4P3N025A	€ 5,90	25 mm	34 mm	26 mm	42 mm
BN4P3N026A	€ 6,00	26 mm	35,4 mm	28 mm	42 mm
BN4P3N027A	€ 6,00	27 mm	36 mm	28 mm	42 mm
BN4P3N028A	€ 6,30	28 mm	38 mm	28 mm	43 mm
BN4P3N029A	€ 6,60	29 mm	38 mm	28 mm	43 mm
BN4P3N030A	€ 6,60	30 mm	40 mm	28 mm	43 mm
BN4P3N032A	€ 6,60	32 mm	42 mm	28 mm	44 mm

BN4P3LX

CHIAVE A BUSSOLA POLIGONALE LUNGA

DIN 3124.



Art.	€	Misura	D1	D2	Lunghezza
BN4P3L010A	€ 6,60	10 mm	15 mm	22 mm	77 mm
BN4P3L011A	€ 6,60	11 mm	16,3 mm	22 mm	77 mm
BN4P3L012A	€ 6,60	12 mm	17,6 mm	22 mm	77 mm
BN4P3L013A	€ 6,60	13 mm	18,8 mm	22 mm	77 mm
BN4P3L014A	€ 6,80	14 mm	20,4 mm	22 mm	77 mm
BN4P3L015A	€ 6,80	15 mm	21 mm	22 mm	77 mm
BN4P3L016A	€ 6,80	16 mm	22 mm	20,5 mm	77 mm
BN4P3L017A	€ 7,10	17 mm	24 mm	22 mm	77 mm
BN4P3L018A	€ 7,60	18 mm	25,4 mm	22 mm	77 mm
BN4P3L019A	€ 7,60	19 mm	26 mm	22 mm	77 mm
BN4P3L020A	€ 8,00	20 mm	28 mm	22 mm	77 mm
BN4P3L021A	€ 8,30	21 mm	28 mm	22 mm	77 mm
BN4P3L022A	€ 8,80	22 mm	30 mm	26 mm	77 mm
BN4P3L023A	€ 10,60	23 mm	31,6 mm	26 mm	77 mm
BN4P3L024A	€ 10,60	24 mm	32 mm	26 mm	77 mm
BN4P3L027A	€ 15,50	27 mm	36 mm	28 mm	77 mm
BN4P3L030A	€ 16,80	30 mm	40 mm	28 mm	77 mm
BN4P3L032A	€ 16,80	32 mm	42 mm	28 mm	77 mm

BN413NX

BUSSOLA CON INSERTO ESAGONALE

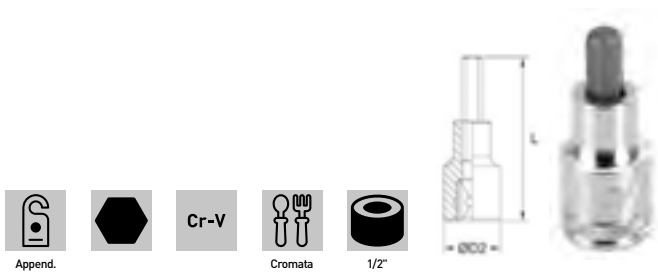

Art.	€	Misura	D2	Lunghezza
BN413N004A	€ 6,10	4 mm	22 mm	55 mm
BN413N005A	€ 6,10	5 mm	22 mm	55 mm
BN413N006A	€ 6,10	6 mm	22 mm	55 mm
BN413N007A	€ 6,70	7 mm	22 mm	55 mm
BN413N008A	€ 6,70	8 mm	22 mm	55 mm
BN413N010A	€ 6,70	10 mm	22 mm	55 mm
BN413N012A	€ 6,70	12 mm	22 mm	55 mm
BN413N014A	€ 8,00	14 mm	24 mm	55 mm
BN413N017A	€ 8,60	17 mm	26 mm	55 mm
BN413N019A	€ 8,60	19 mm	28 mm	55 mm

BN413LX

BUSSOLA CON INSERTO ESAGONALE LUNGO

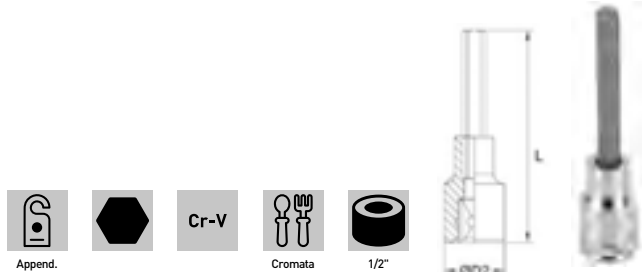

Art.	€	Misura	D2	Lunghezza
BN413L004A	€ 8,00	4 mm	22 mm	100 mm
BN413L005A	€ 8,00	5 mm	22 mm	100 mm
BN413L006A	€ 8,00	6 mm	22 mm	100 mm
BN413L007A	€ 8,00	7 mm	22 mm	100 mm
BN413L008A	€ 8,00	8 mm	22 mm	100 mm
BN413L010A	€ 8,00	10 mm	22 mm	100 mm
BN413L012A	€ 8,10	12 mm	22 mm	100 mm
BN413L014A	€ 8,10	14 mm	24 mm	100 mm
BN413L017A	€ 11,70	17 mm	26 mm	100 mm
BN413L019A	€ 12,60	19 mm	28 mm	100 mm

BN423NX

BUSSOLA CON INSERTO TORX

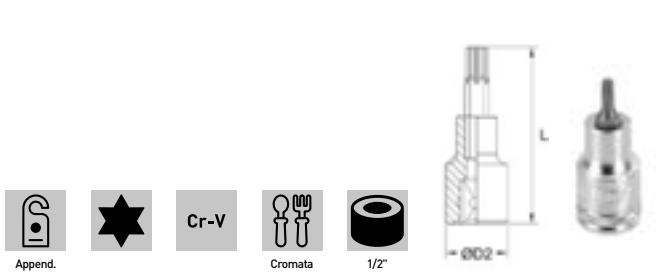

Art.	€	Misura	D2	Lunghezza
BN423N020A	€ 7,60	T20	22 mm	55 mm
BN423N025A	€ 7,60	T25	22 mm	55 mm
BN423N027A	€ 7,60	T27	22 mm	55 mm
BN423N030A	€ 7,60	T30	22 mm	55 mm
BN423N040A	€ 8,20	T40	22 mm	55 mm
BN423N045A	€ 8,20	T45	22 mm	55 mm
BN423N050A	€ 8,20	T50	22 mm	55 mm
BN423N055A	€ 9,20	T55	22 mm	55 mm
BN423N060A	€ 9,70	T60	22 mm	55 mm
BN423N070A	€ 11,90	T70	22 mm	55 mm

BN423LX

BUSSOLA CON INSERTO TORX LUNGO

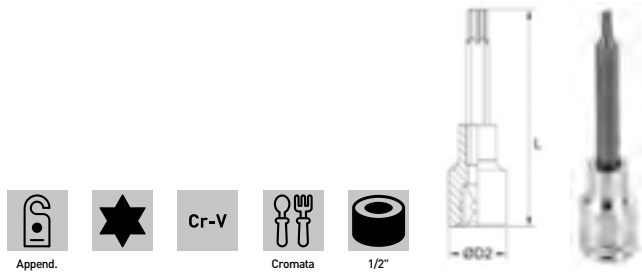

Art.	€	Misura	D2	Lunghezza
BN423L020A	€ 8,60	T20	22 mm	100 mm
BN423L025A	€ 8,60	T25	22 mm	100 mm
BN423L027A	€ 8,60	T27	22 mm	100 mm
BN423L030A	€ 8,60	T30	22 mm	100 mm
BN423L040A	€ 9,00	T40	22 mm	100 mm
BN423L045A	€ 9,00	T45	22 mm	100 mm
BN423L050A	€ 9,00	T50	22 mm	100 mm
BN423L055A	€ 10,70	T55	22 mm	100 mm
BN423L060A	€ 10,70	T60	22 mm	100 mm
BN423L070A	€ 14,40	T70	22 mm	100 mm

BN433NX

BUSSOLA CON INSERTO RIBE



Art.	€	Misura	D2	Lunghezza
BN433N008A	€ 8,20	M 8	22 mm	55 mm
BN433N009A	€ 8,20	M 9	22 mm	55 mm
BN433N010A	€ 8,20	M 10	22 mm	55 mm
BN433N012A	€ 9,00	M 12	22 mm	55 mm
BN433N013A	€ 9,60	M 13	24 mm	55 mm
BN433N014A	€ 9,60	M 14	24 mm	55 mm

BN433LX

BUSSOLA CON INSERTO RIBE LUNGO



Art.	€	Misura	D2	Lunghezza
BN433L008A	€ 10,20	M 8	24 mm	100 mm
BN433L009A	€ 10,20	M 9	24 mm	100 mm
BN433L010A	€ 10,20	M 10	24 mm	100 mm
BN433L012A	€ 11,10	M 12	24 mm	100 mm
BN433L013A	€ 11,10	M 13	24 mm	100 mm
BN433L014A	€ 12,90	M 14	24 mm	100 mm



BN443NX

BUSSOLA CON INSERTO XZN



Cr-V



Art.	€	Misura	D2	Lunghezza
BN443N005A	€ 8,60	M 5	22 mm	55 mm
BN443N006A	€ 8,60	M 6	22 mm	55 mm
BN443N008A	€ 8,60	M 8	22 mm	55 mm
BN443N009A	€ 8,60	M 9	22 mm	55 mm
BN443N010A	€ 8,60	M 10	22 mm	55 mm
BN443N012A	€ 9,70	M 12	22 mm	55 mm
BN443N014A	€ 9,70	M 14	24 mm	55 mm
BN443N016A	€ 9,80	M 16	24 mm	55 mm

BN443LX

BUSSOLA CON INSERTO XZN LUNGO



Cr-V



Art.	€	Misura	D2	Lunghezza
BN443L005A	€ 9,80	M 5	22 mm	100 mm
BN443L006A	€ 9,80	M 6	22 mm	100 mm
BN443L008A	€ 9,80	M 8	22 mm	100 mm
BN443L009A	€ 10,30	M 9	22 mm	100 mm
BN443L010A	€ 10,30	M 10	22 mm	100 mm
BN443L012A	€ 10,80	M 12	22 mm	100 mm
BN443L014A	€ 11,40	M 14	24 mm	100 mm
BN443L016A	€ 11,80	M 16	24 mm	100 mm

BN4C3LX

CHIAVE A BUSSOLA PER CANDELA



Cr-V



Art.	€	Misura	Lunghezza
BN4C3L016A	€ 4,95	16 mm	65 mm
BN4C3L018A	€ 5,80	18 mm	65 mm
BN4C3L021A	€ 7,00	21 mm	65 mm

PN403NX

PROLUNGA



Art.	€	Lunghezza
PN403N050A	€ 5,10	50 mm
PN403N075A	€ 6,50	75 mm
PN403N150A	€ 9,10	150 mm
PN403N250A	€ 11,20	250 mm

EN403NX

PROLUNGA A TESTA SFERICA



Cr-V



Art.	€	Attacco quadro	Lunghezza
EN403N050A	€ 6,00	1/2"	50 mm
EN403N075A	€ 6,50	1/2"	75 mm
EN403N125A	€ 9,10	1/2"	125 mm
EN403N250A	€ 15,50	1/2"	250 mm
EN403N500A	€ 26,00	1/2"	500 mm

LN400N1/2A

€ 12,60

LEVA A T SCORREVOLE



Lunghezza 300 mm

RN4034NA

€ 3,73

RACCORDO



Lunghezza 36 mm

RN4032NA

€ 8,60

RACCORDO



Lunghezza 46 mm

JN403NA

€ 10,60

SNODO A CARDANO



Lunghezza 75 mm

BN4E2NX

CHIAVE A BUSSOLA ESAGONALE, SERIE NORMALE

DIN 3124.

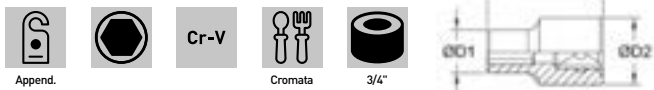

Art.	€	Misura	D1	D2	Lunghezza
BN4E2N019	€ 8,10	19 mm	30 mm	36 mm	50 mm
BN4E2N020	€ 8,10	20 mm	31 mm	36 mm	50 mm
BN4E2N021	€ 8,10	21 mm	32 mm	36 mm	50 mm
BN4E2N022	€ 8,10	22 mm	33 mm	36 mm	50 mm
BN4E2N023	€ 8,10	23 mm	34 mm	36 mm	50 mm
BN4E2N024	€ 8,10	24 mm	35 mm	36 mm	50 mm
BN4E2N025	€ 8,10	25 mm	36 mm	35 mm	52 mm
BN4E2N026	€ 8,10	26 mm	37 mm	36 mm	52 mm
BN4E2N027	€ 9,60	27 mm	38 mm	36 mm	52 mm
BN4E2N028	€ 9,60	28 mm	39 mm	38 mm	52 mm
BN4E2N029	€ 9,60	29 mm	40 mm	38 mm	52 mm
BN4E2N030	€ 9,60	30 mm	42 mm	38 mm	54 mm
BN4E2N032	€ 9,60	32 mm	43 mm	38 mm	56 mm
BN4E2N033	€ 10,20	33 mm	44 mm	38 mm	56 mm
BN4E2N034	€ 10,20	34 mm	46 mm	38 mm	56 mm
BN4E2N035	€ 10,50	35 mm	47 mm	42 mm	56 mm
BN4E2N036	€ 10,50	36 mm	48 mm	42 mm	58 mm
BN4E2N038	€ 12,60	38 mm	50 mm	42 mm	58 mm
BN4E2N041	€ 14,20	41 mm	52 mm	45 mm	60 mm
BN4E2N046	€ 15,70	46 mm	56 mm	45 mm	64 mm
BN4E2N050	€ 18,90	50 mm	62 mm	48 mm	68 mm
BN4E2N055	€ 23,00	55 mm	68 mm	48 mm	72 mm
BN4E2N060	€ 28,60	60 mm	74 mm	48 mm	76 mm

BN4P2NX

CHIAVE A BUSSOLA POLIGONALE, SERIE NORMALE

DIN 3124.



Art.	€	Misura	D1	D2	Lunghezza
BN4P2N019	€ 7,50	19 mm	30 mm	36 mm	50 mm
BN4P2N020	€ 7,50	20 mm	31 mm	36 mm	50 mm
BN4P2N021	€ 7,50	21 mm	32 mm	36 mm	50 mm
BN4P2N022	€ 7,50	22 mm	33 mm	36 mm	50 mm
BN4P2N023	€ 7,50	23 mm	34 mm	36 mm	50 mm
BN4P2N024	€ 7,50	24 mm	35 mm	36 mm	50 mm
BN4P2N025	€ 7,50	25 mm	36 mm	35 mm	52 mm
BN4P2N026	€ 7,50	26 mm	37 mm	36 mm	52 mm
BN4P2N027	€ 9,10	27 mm	38 mm	36 mm	52 mm
BN4P2N028	€ 9,10	28 mm	39 mm	38 mm	52 mm
BN4P2N029	€ 9,10	29 mm	40 mm	38 mm	52 mm
BN4P2N030	€ 9,10	30 mm	42 mm	38 mm	54 mm
BN4P2N032	€ 9,10	32 mm	43 mm	38 mm	56 mm
BN4P2N033	€ 9,60	33 mm	44 mm	38 mm	56 mm
BN4P2N034	€ 10,20	34 mm	46 mm	38 mm	56 mm
BN4P2N035	€ 10,20	35 mm	47 mm	42 mm	56 mm
BN4P2N036	€ 10,20	36 mm	48 mm	42 mm	58 mm
BN4P2N038	€ 11,90	38 mm	50 mm	42 mm	58 mm
BN4P2N041	€ 13,40	41 mm	52 mm	45 mm	60 mm
BN4P2N046	€ 14,90	46 mm	56 mm	45 mm	64 mm
BN4P2N050	€ 17,90	50 mm	62 mm	48 mm	68 mm
BN4P2N055	€ 23,00	55 mm	68 mm	48 mm	72 mm
BN4P2N060	€ 28,60	60 mm	74 mm	48 mm	76 mm

PN402NX

PROLUNGA



Art.	€	Lunghezza
PN402N200A	€ 18,90	200 mm
PN402N400A	€ 29,00	400 mm

LN400N3/4A

€ 31,10

LEVA A T SCORREVOLE



Lunghezza	€
500 mm	€ 31,10

RN4023NA

€ 8,60

RACCORDO



Lunghezza	€
50 mm	€ 8,60

JN402NA

€ 43,00

SNODO A CARDANO

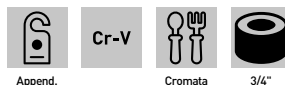

Lunghezza	€
110 mm	€ 43,00



0795/2

€ 64,00

SERIE CHIAVI MULTILOCK

Adatte per dadi e bulloni metrici, a pollici, torx e XZN.

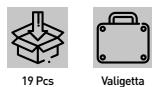

Misure	8 - 9 - 10 - 11 - 12 - 13 - 14 - 15 - 16 - 17 - 18 - 19 - 20 - 21 - 22 - 24 - 27 - 30 - 32 mm
Misure in pollici	3/8" - 7/16" - 15/32" - 1/2" - 19/32" - 5/8" - 3/4" - 25/32" - 13/16" - 7/8" - 15/16" - 1-1/16" - 1-13/16" - 1-1/4"
Misure torx	E12 - E14 - E16 - E18 - E20 - E22 - E24 - E26 - E28 - E30 - E34 - E38 - E40
Misure XZN	M12 - M14 - M16 - M18

0795/1

€ 23,20

SERIE CHIAVI MULTILOCK

Adatte per dadi e bulloni metrici, a pollici, torx e XZN.

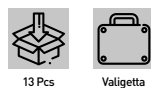

Misure	4 - 4,5 - 5 - 5,5 - 6 - 7 - 8 - 9 - 10 - 11 - 12 - 13 - 14 mm
Misure in pollici	5/32" - 7/32" - 1/4" - 5/16" - 11/32" - 3/8" - 7/16" - 15/32" - 1/2"
Misure torx	E5 - E6 - E8 - E10 - E12 - E14 - E16 - E18
Misure XZN	M5 - M6 - M8 - M9 - M10 - M12 - M14 - M16 - M18

0195

€ 46,60

SERIE CHIAVI A BUSSOLA TORX

Adatte per bulloni torx

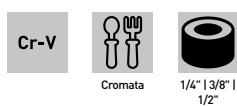

Misure torx	1/4"; E4 - E5 - E6 - E7 - E8 - E10 - E11 3/8"; E4 - E5 - E6 - E7 - E8 - E10 - E11 - E12 - E14 - E16 - E18 - E20 1/2"; E10 - E11 - E12 - E14 - E16 - E18 - E20 - E22 - E24
-------------	---

SN4E5C012

PRO € 59,30

SERIE BUSSOLE A PROFILO RIBASSATO

Composto da 11 bussole e 1 cricchetto reversibile ribassato a 60 denti, di altezza ridotta per poter operare in piccoli spazi

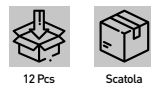

Bussole	4, 5, 6, 7, 8, 9, 10, 11, 12, 13, 14 mm
---------	---

SN4E4C013

PRO € 77,50

SERIE BUSSOLE A PROFILO RIBASSATO

Composto da 12 bussole e 1 cricchetto reversibile ribassato a 60 denti, di altezza ridotta per poter operare in piccoli spazi

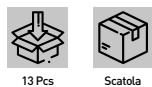

Bussole	8, 9, 10, 11, 12, 13, 14, 15, 16, 17, 18, 19 mm
---------	---

SN4E3C015

PRO € 98,60

SERIE BUSSOLE A PROFILO RIBASSATO

Composto da 14 bussole e 1 cricchetto reversibile ribassato a 60 denti, di altezza ridotta per poter operare in piccoli spazi

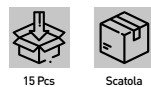

Bussole	8, 10, 11, 12, 13, 14, 15, 17, 18, 19, 21, 22, 23, 24 mm
---------	--

0589 € 71,50

SERIE BUSSOLE MULTIPROFILO RIBASSATE

Con foro passante, composto da 11 bussole, 1 cricchetto reversibile ribassato con foro passante e accessori, adatte a esagoni metrici, in pollici, torx, XZN, barre filettate e prigionieri, di altezza ridotta per poter operare in piccoli spazi.

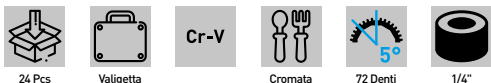

Bussole	4.5 - 5 - 5.5 - 6 - 7 - 8 - 9 - 10 - 11 - 12 - 13 mm
Cricchetto reversibile	
Prolunga	50 mm
Adattatore	1/4"
Adattatore inserti	
Inserti	PH: 1 - 2 - 3 (S2) Torx: T10-T15-T20-T25-T30-T40 (S2)

0624 € 67,30

SERIE CHIAVI A BUSSOLA DA 1/4"



Bussole da 1/4"	4 - 4.5 - 5 - 5.5 - 6 - 7 - 8 - 9 - 10 - 11 - 12 - 13 - 14 mm
Bussole con inserti	1/4": T8 - T10 - T15 - T20 - T25 - T30 - T40 - H3 - H4 - H5 - H6 - H7 - H8 - SL4 - SL5.5 - SL7 - PH1 - PH2 - PH3 - PZ1 - PZ2 - PZ3
Cricchetto reversibile	1/4"
Prolunga flessibile	1/4" - 150 mm
Prolunghe da 1/4"	50 - 100 mm
Manico per bussole	1/4"
Snodo universale	1/4"
Leva a T scorrevole	1/4"
Chiavi esagonali	1,27 - 1,5 - 2 - 2.5 mm

S520 € 41,00

SERIE BUSSOLE ESAGONALI A POLLICE DA 1/4"



Bussole da 1/4"	5/32", 3/16", 7/32", 1/4", 9/32" 5/16", 11/32", 3/8", 13/32", 7/16", 15/32", 1/2", 9/16"
Snodo universale	1/4"
Prolunghe da 1/4"	2", 4", 6"
Leva a T scorrevole	1/4"
Manico per bussole	1/4"
Cricchetto reversibile	1/4"

0679 € 77,00

SERIE CHIAVI A BUSSOLA DA 3/8" E 1/4"

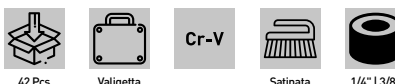

Bussole da 3/8"	9 - 10 - 11 - 12 - 13 - 14 - 15 - 17 - 19 mm
Misure bussole per candela	3/8" : 16 - 21 mm
Prolunghe da 3/8"	75 - 150 mm
Snodo universale	3/8"
Raccordo	F. 1/2" - M. 3/8"
Cricchetto reversibile	3/8"
Bussole da 1/4"	4 - 4.5 - 5 - 5.5 - 6 - 7 - 8 - 9 - 10 - 11 - 12 - 13 mm
Manico per bussole	1/4"
Raccordo	F. 3/8" - M. 1/4"
Bussola porta inserti	1/4"
Inserti	PH1 - PH2 - PH3 - H3 - H4 - H5 - H6 - H7 - SL4 - SL5,5 - SL7



S328 **PRO** € 134,00
SERIE CHIAVI A BUSSOLA DA 1/2"



Bussole da 1/2"	8 - 9 - 10 - 11 - 12 - 13 - 14 - 15 - 16 - 17 - 18 - 19 - 20 - 21 - 22 - 23 - 24 - 27 - 30 - 32 mm
Misure bussole per candela	1/2" : 16 - 21 mm
Prolunghe da 1/2"	75 - 150 - 250 mm
Snodo universale	1/2"
Raccordo	F. 3/8" - M. 1/2"
Cricchetto reversibile	1/2"

SN4P3N027 **PRO** € 119,00
SERIE BUSSOLE ESAGONALI A POLLICE DA 1/2"

Composta da 20 bussole normali, 2 bussole per candela, 1 cricchetto reversibile, 1 snodo universale, 2 prolunghe e 1 leva a T scorrevole.



Misure bussole normali	5/16", 3/8", 7/16", 15/32", 1/2", 9/16", 19/32", 5/8", 11/16", 3/4", 25/32", 13/16", 7/8", 15/16", 1", 1-1/16", 1-3/16", 1-1/4", 23/32", 1-1/8"
Misure bussole per candela	5/8", 13/16"
Misure prolunghe	3", 10"

0620 € 119,00
SERIE CHIAVI A BUSSOLA DA 1/2"

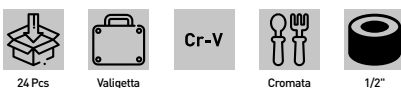

Bussole da 1/2"	10 - 11 - 12 - 13 - 14 - 15 - 16 - 17 - 18 - 19 - 20 - 21 - 22 - 23 - 24 - 27 - 30 - 32 mm
Misure bussole per candela	1/2" : 21 mm
Prolunghe da 1/2"	125 - 250 mm
Snodo universale	1/2"
Leva a T scorrevole	1/2"
Cricchetto reversibile	1/2"

0181 € 159,00
SERIE CHIAVI A BUSSOLA DA 3/4"



Misure	19 - 21 - 22 - 23 - 24 - 26 - 27 - 30 - 32 - 34 - 36 - 38 - 41 - 46 - 48 - 50 mm
Cricchetto reversibile	3/4"
Leva a T scorrevole	3/4"
Prolunghe	3/4" : 100 - 200 mm

0622

€ 50,70

SERIE BUSSOLE CON INSERTI TORX



Misure T20 - T25 - T27 - T30 - T40 T45 - T50 - T55 - T60 - T70



S108

€ 179,00

SERIE CHIAVI A BUSSOLA

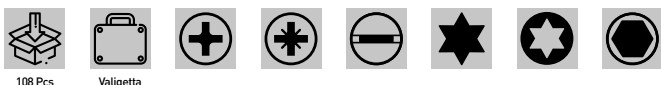

Bussole da 1/4"	4 - 4.5 - 5 - 5.5 - 6 - 7 - 8 - 9 - 10 - 11 - 12 - 13 - 14 mm
Bussole lunghe da 1/4"	6 - 7 - 8 - 9 - 10 - 11 - 12 - 13 mm
Bussole lunghe da 1/4"	Torx: E4 - E5 - E6 - E7 - E8 mm
Bussole da 1/2"	10 - 11 - 12 - 13 - 14 - 15 - 16 - 17 - 18 - 19 - 20 - 21 - 22 - 24 - 27 - 30 - 32 mm
Bussole lunghe da 1/2"	14 - 15 - 17 - 19 - 22 mm
Bussole da 1/2"	Torx: E10 - E11 - E12 - E14 - E16 - E18 - E20 - E24
Bussole con inserti	1/4" : T8 - T10 - T15 - T20 - T25 - T27 - T30 - H3 - H4 - H5 - H6 - SL4 - SL5.5 - SL6.5 - PH1 - PH2 - PZ1 - PZ2
Misure bussole per candela	1/2" : 16 - 21 mm
Bussole porta inserti	1/2"
Inserti	5/16" x 30mm : H7 - H8 - H10 - H12 - H14 - SL8 - SL10 - SL12 - PH3 - PH4 - PZ3 - PZ4 - T40 - T45 - T50 - T55 - T60
Prolunghe da 1/4"	50 - 85 mm
Prolunghe da 1/2"	125 - 250 mm
Manico per bussole	1/4"
Raccordo	F. 3/8" - M. 1/2"
Snodo universale	1/4"
Snodo universale	1/2"
Leva a T scorrevole	1/4"
Cricchetto reversibile	1/4"
Cricchetto reversibile	1/2"
Chiavi esagonali	1.5 - 2 - 2.5 mm





0618

€ 198,00

SERIE CHIAVI A BUSSOLA DA 1/2" E 1/4"



94 Pcs



Valigetta



Bussole da 1/4"	4 - 4.5 - 5 - 5.5 - 6 - 7 - 8 - 9 - 10 - 11 - 12 - 13 - 14 mm
Bussole lunghe da 1/4"	6 - 7 - 8 - 9 - 10 - 11 - 12 - 13 mm
Adattatore maschio con quadro da 1/4" e esagono da 1/4"	
Bussole da 1/2"	10 - 11 - 12 - 13 - 14 - 15 - 16 - 17 - 18 - 19 - 20 - 21 - 22 - 23 - 24 - 27 - 30 - 32 mm
Bussole lunghe da 1/2"	14 - 15 - 17 - 19 mm
Prolunga flessibile	1/4" - 150 mm
Bussole con inserti	1/4" : T8 - T10 - T15 - T20 - T25 - T30 - H3 - H4 - H5 - H6 - SL4 - SL5.5 - SL7 - PH1 - PH2 - PZ1 - PZ2
Misure bussole per candela	1/2" : 16 - 21 mm
Bussole per inserti da 5/16"	1/2"
Inserti	5/16" x 30mm : H8 - H10 - H12 - H14 - SL8 - SL10 - SL12 - PH3 - PH4 - PZ3 - PZ4 - T40 - T45 - T50 - T55
Prolunghe da 1/4"	50 - 100 mm
Prolunghe da 1/2"	125 - 250 mm
Manico per bussole	1/4"
Raccordo	F. 3/8" - M. 1/2"
Snodo universale	1/4"
Snodo universale	1/2"
Leva a T scorrevole	1/4"
Cricchetto reversibile	1/4"
Cricchetto reversibile	1/2"
Chiavi esagonali	1.5 - 2 - 2.5 mm



S179

€ 307,00

SERIE CHIAVI A BUSSOLA



179 Pcs



Valigetta



Bussole da 1/4"	4 - 4.5 - 5 - 5.5 - 6 - 7 - 8 - 9 - 10 - 11 - 12 - 13 - 14 mm
Bussole lunghe da 1/4"	6 - 7 - 8 - 9 - 10 mm
Bussole lunghe da 1/4"	Torx: E4 - E5 - E6 - E7 - E8 mm
Prolunghe da 1/4"	50 - 100 mm
Leva a T scorrevole	1/4"
Bussole porta inserti	1/4"
Bussole con inserti	1/4" - Torx: T8 - T9 - T10 - T15 - T20 - T25 - T27 - T30
Bussole con inserti con foro	1/4" - Torx: T8H - T9H - T10H - T15H - T20H - T25H - T27H - T30H
Bussole con inserti	1/4" : PH0 - PH1 - PH2
Bussole con inserti	1/4" : PZ0 - PZ1 - PZ2
Bussole con inserti esagonali	1/4" : 3 - 4 - 5 - 6 mm
Bussole con inserti a taglio	1/4" : 4 - 5.5 - 6.5 - 7 mm
Snodo universale	1/4"
Manico per bussole	1/4"
Cricchetto reversibile	1/4"
Bussole da 3/8"	10 - 11 - 12 - 13 - 14 - 15 - 16 - 17 - 18 - 19 mm
Bussole da 3/8"	Torx: E10 - E11 - E12 - E13
Bussole lunghe da 3/8"	10 - 11 - 12 - 13 - 14 - 15 mm
Misure bussole per candela	3/8" - 18 mm
Prolunghe da 3/8"	150 mm
Bussole per inserti da 5/16"	3/8"
Snodo universale	3/8"
Cricchetto reversibile	3/8"
Bussole da 1/2"	10 - 11 - 12 - 13 - 14 - 15 - 16 - 17 - 18 - 19 - 20 - 21 - 22 - 24 - 27 - 30 - 32 mm
Bussole lunghe da 1/2"	16 - 17 - 18 - 19 - 22 mm
Bussole da 1/2"	Torx: E16 - E18 - E20 - E24
Misure bussole per candela	1/2" : 16 - 21 mm
Prolunghe da 1/2"	125 - 250 mm



Bussole per inserti da 5/16"	1/2"
Snodo universale	1/2"
Raccordo	F. 3/8" - M. 1/2"
Cricchetto reversibile	1/2"
Inserti	1/4" x 25 mm XZN: M5 - M6 - M8
Inserti	1/4" x 25 mm Torx: T5 - T6 - T7 - T8 - T9 - T10 - T15 - T20 - T25 - T27 - T30
Inserti	1/4" x 25 mm Ribe: RM5 - RM6 - RM7 - RM8 - RM9
Inserti	1/4" x 25 mm Torx "5": TS7 - TS10 - TS15 - TS20 - TS25 - TS27 - TS30 - TS40 - TS45
Inserti	5/16" x 30 mm Torx: T40 - T45 - T50 - T55 - T60 - T70
Inserti con foro	5/16" x 30 mm Torx: T40H - T45H - T50H - T55H - T60H - T70H
Inserti esagonali	5/16" x 30 mm: 7 - 8 - 10 - 12 - 14 mm
Inserti	5/16" x 30 mm: PH3 - PH4
Inserti	5/16" x 30 mm: PZ3 - PZ4
Inserti a taglio	5/16" x 30 mm: 8 - 10 - 12 mm
Chiavi esagonali	1.3 - 1.5 - 2 - 2.5 - 3 - 4 - 5 mm

BI4E3NX
CHIAVE A BUSSOLA AD IMPATTO, SERIE NORMALE

DIN 3129.

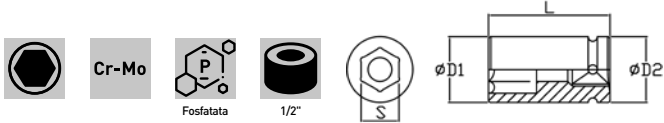

Art.	€	Misura	D1	D2	Lunghezza
BI4E3N008	€ 4,04	8 mm	15 mm	24 mm	38 mm
BI4E3N009	€ 4,04	9 mm	16 mm	24 mm	38 mm
BI4E3N010	€ 4,04	10 mm	17,5 mm	24 mm	38 mm
BI4E3N011	€ 4,04	11 mm	18,5 mm	24 mm	38 mm
BI4E3N012	€ 4,04	12 mm	19,5 mm	24 mm	38 mm
BI4E3N013	€ 4,04	13 mm	20,5 mm	24 mm	38 mm
BI4E3N014	€ 4,04	14 mm	22 mm	24 mm	38 mm
BI4E3N015	€ 4,56	15 mm	24 mm	24 mm	38 mm
BI4E3N016	€ 4,56	16 mm	24 mm	24 mm	38 mm
BI4E3N017	€ 4,56	17 mm	26 mm	26 mm	38 mm
BI4E3N018	€ 4,56	18 mm	28 mm	28 mm	38 mm
BI4E3N019	€ 4,56	19 mm	28 mm	28 mm	38 mm
BI4E3N020	€ 5,50	20 mm	30 mm	30 mm	38 mm
BI4E3N021	€ 5,50	21 mm	30 mm	30 mm	38 mm
BI4E3N022	€ 5,50	22 mm	32 mm	30 mm	38 mm
BI4E3N023	€ 5,80	23 mm	34 mm	30 mm	38 mm
BI4E3N024	€ 5,80	24 mm	34 mm	30 mm	38 mm
BI4E3N025	€ 5,80	25 mm	36 mm	30 mm	38 mm
BI4E3N026	€ 6,50	26 mm	36 mm	30 mm	38 mm
BI4E3N027	€ 6,50	27 mm	38 mm	30 mm	42 mm
BI4E3N028	€ 7,70	28 mm	40 mm	30 mm	42 mm
BI4E3N029	€ 7,70	29 mm	42 mm	30 mm	42 mm
BI4E3N030	€ 8,30	30 mm	42 mm	30 mm	42 mm
BI4E3N031	€ 8,50	31 mm	44 mm	30 mm	42 mm
BI4E3N032	€ 9,30	32 mm	44 mm	30 mm	44 mm

BI4E3LX
CHIAVE A BUSSOLA AD IMPATTO LUNGA

DIN 3129.

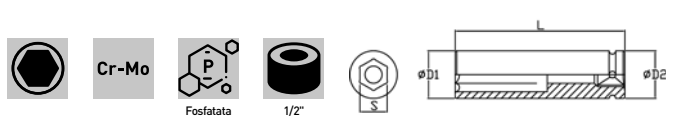

Art.	€	Misura	D1	D2	Lunghezza
BI4E3L008	€ 6,70	8 mm	15 mm	24 mm	78 mm
BI4E3L009	€ 6,70	9 mm	16 mm	24 mm	78 mm
BI4E3L010	€ 6,70	10 mm	17,5 mm	24 mm	78 mm
BI4E3L011	€ 6,70	11 mm	18,5 mm	24 mm	78 mm
BI4E3L012	€ 6,70	12 mm	19,5 mm	24 mm	78 mm
BI4E3L013	€ 6,70	13 mm	20,5 mm	24 mm	78 mm
BI4E3L014	€ 6,70	14 mm	22 mm	24 mm	78 mm
BI4E3L015	€ 8,00	15 mm	24 mm	24 mm	78 mm
BI4E3L016	€ 8,00	16 mm	24 mm	24 mm	78 mm
BI4E3L017	€ 8,00	17 mm	26 mm	26 mm	78 mm
BI4E3L018	€ 8,00	18 mm	28 mm	28 mm	78 mm
BI4E3L019	€ 8,00	19 mm	28 mm	28 mm	78 mm
BI4E3L020	€ 8,00	20 mm	30 mm	30 mm	78 mm
BI4E3L021	€ 8,00	21 mm	30 mm	30 mm	78 mm
BI4E3L022	€ 8,30	22 mm	32 mm	30 mm	78 mm
BI4E3L023	€ 8,50	23 mm	34 mm	30 mm	78 mm
BI4E3L024	€ 9,70	24 mm	34 mm	30 mm	78 mm
BI4E3L025	€ 10,60	25 mm	36 mm	30 mm	78 mm
BI4E3L026	€ 10,80	26 mm	36 mm	30 mm	78 mm
BI4E3L027	€ 10,80	27 mm	38 mm	30 mm	78 mm
BI4E3L028	€ 11,40	28 mm	40 mm	30 mm	78 mm
BI4E3L029	€ 11,40	29 mm	42 mm	30 mm	78 mm
BI4E3L030	€ 11,40	30 mm	42 mm	30 mm	78 mm
BI4E3L031	€ 11,80	31 mm	44 mm	30 mm	78 mm
BI4E3L032	€ 11,80	32 mm	44 mm	30 mm	78 mm





BI413LOX

BUSSOLA ESAGONALE MASCHIO AD IMPATTO

DIN 3129.

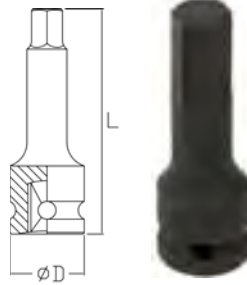
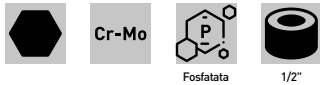

Art.	€	Misura	D	Lunghezza
BI413L004	€ 6,30	4 mm	25 mm	78 mm
BI413L005	€ 6,30	5 mm	25 mm	78 mm
BI413L006	€ 6,30	6 mm	25 mm	78 mm
BI413L008	€ 6,30	8 mm	25 mm	78 mm
BI413L010	€ 6,30	10 mm	25 mm	78 mm
BI413L012	€ 6,30	12 mm	25 mm	78 mm
BI413L014	€ 6,30	14 mm	25 mm	78 mm
BI413L017	€ 7,10	17 mm	25 mm	78 mm
BI413L019	€ 7,70	19 mm	25 mm	78 mm

BI423LX

BUSSOLA TORX MASCHIO AD IMPATTO

DIN 3121 & 3129.

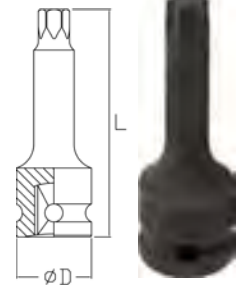
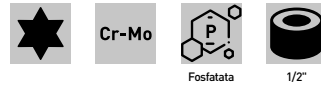

Art.	€	Misura	D	Lunghezza
BI423L025	€ 7,10	T25	25 mm	78 mm
BI423L027	€ 7,10	T27	25 mm	78 mm
BI423L030	€ 7,10	T30	25 mm	78 mm
BI423L040	€ 7,60	T40	25 mm	78 mm
BI423L045	€ 7,70	T45	25 mm	78 mm
BI423L050	€ 7,70	T50	25 mm	78 mm
BI423L060	€ 10,00	T60	25 mm	78 mm
BI423L070	€ 11,20	T70	25 mm	78 mm
BI423L080	€ 11,60	T80	25 mm	78 mm

BI433MX

BUSSOLA RIBE MASCHIO AD IMPATTO

DIN 3121 & 3129.

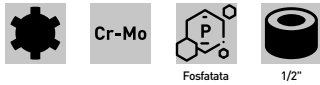

Art.	€	Misura	D	Lunghezza
BI433M004	€ 6,20	4	25 mm	60 mm
BI433M005	€ 6,20	5	25 mm	60 mm
BI433M006	€ 6,20	6	25 mm	60 mm
BI433M007	€ 6,20	7	25 mm	60 mm
BI433M008	€ 6,20	8	25 mm	60 mm
BI433M009	€ 6,20	9	25 mm	60 mm
BI433M010	€ 6,20	10	25 mm	60 mm
BI433M012	€ 7,10	12	25 mm	60 mm
BI433M014	€ 7,70	14	25 mm	60 mm
BI433M016	€ 8,00	16	25 mm	60 mm
BI433M018	€ 8,30	18	25 mm	60 mm

BI443MX

BUSSOLA XZN MASCHIO AD IMPATTO

DIN 3121 & 3129.

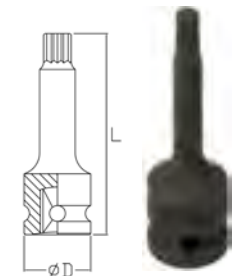
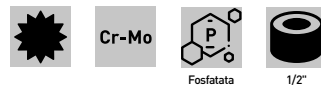

Art.	€	Misura	D	Lunghezza
BI443M004	€ 6,20	4	25 mm	60 mm
BI443M005	€ 6,20	5	25 mm	60 mm
BI443M006	€ 6,20	6	25 mm	60 mm
BI443M008	€ 6,20	8	25 mm	60 mm
BI443M010	€ 6,20	10	25 mm	60 mm
BI443M012	€ 6,20	12	25 mm	60 mm
BI443M014	€ 6,50	14	25 mm	60 mm
BI443M016	€ 6,70	16	25 mm	60 mm
BI443M018	€ 7,20	18	25 mm	60 mm
BI443M020	€ 7,70	20	25 mm	60 mm

PI403X

PROLUNGA AD IMPATTO

DIN 3121 & 3129.

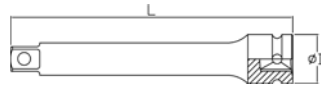

Art.	€	D	Lunghezza
PI403075	€ 8,00	25 mm	75 mm
PI403125	€ 8,70	25 mm	125 mm
PI403150	€ 10,60	25 mm	150 mm
PI403250	€ 13,10	25 mm	250 mm

PI453X

PROLUNGA A SGANCIO RAPIDO AD IMPATTO

DIN 3121 & 3129.

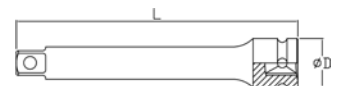
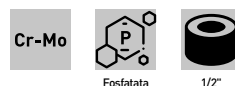

Art.	€	D	Lunghezza
PI453075	€ 18,90	25 mm	75 mm
PI453150	€ 20,40	25 mm	125 mm
PI453250	€ 23,00	25 mm	250 mm

BI4E2NX

CHIAVE A BUSSOLA AD IMPATTO, SERIE NORMALE

DIN 3129.

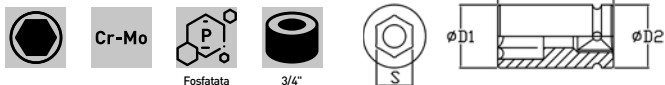

Art.	€	Misura	D1	D2	Lunghezza
BI4E2N018	€ 10,60	18 mm	30 mm	44 mm	51 mm
BI4E2N019	€ 10,60	19 mm	32 mm	44 mm	51 mm
BI4E2N020	€ 10,60	20 mm	33 mm	44 mm	51 mm
BI4E2N021	€ 10,60	21 mm	35 mm	44 mm	51 mm
BI4E2N022	€ 10,60	22 mm	36 mm	44 mm	51 mm
BI4E2N023	€ 10,60	23 mm	38 mm	44 mm	51 mm
BI4E2N024	€ 10,60	24 mm	39 mm	44 mm	51 mm
BI4E2N025	€ 10,60	25 mm	41 mm	44 mm	54 mm
BI4E2N026	€ 10,60	26 mm	41 mm	44 mm	54 mm
BI4E2N027	€ 10,60	27 mm	42 mm	44 mm	54 mm
BI4E2N028	€ 11,30	28 mm	44 mm	44 mm	54 mm
BI4E2N029	€ 11,30	29 mm	46 mm	44 mm	54 mm
BI4E2N030	€ 11,30	30 mm	46 mm	44 mm	54 mm
BI4E2N032	€ 12,60	32 mm	48 mm	44 mm	57 mm
BI4E2N033	€ 12,60	33 mm	50 mm	44 mm	57 mm
BI4E2N034	€ 13,60	34 mm	52 mm	44 mm	57 mm
BI4E2N035	€ 13,70	35 mm	52 mm	44 mm	57 mm
BI4E2N036	€ 13,90	36 mm	54 mm	44 mm	57 mm
BI4E2N038	€ 16,20	38 mm	56 mm	44 mm	57 mm
BI4E2N041	€ 18,00	41 mm	60 mm	44 mm	58 mm
BI4E2N046	€ 19,80	46 mm	66 mm	44 mm	68 mm
BI4E2N050	€ 30,80	50 mm	71 mm	54 mm	68 mm
BI4E2N055	€ 37,70	55 mm	77 mm	54 mm	73 mm
BI4E2N060	€ 40,90	60 mm	84 mm	54 mm	75 mm
BI4E2N065	€ 45,80	65 mm	88 mm	54 mm	78 mm

BI4E2LX

CHIAVE A BUSSOLA AD IMPATTO LUNGA

DIN 3129.

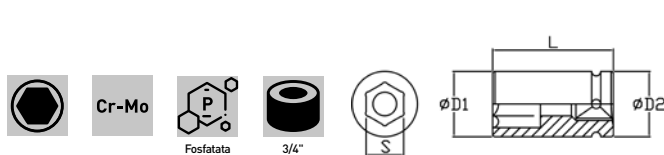

Art.	€	Misura	D1	D2	Lunghezza
BI4E2L018	€ 18,90	18 mm	30 mm	44 mm	90 mm
BI4E2L019	€ 18,90	19 mm	32 mm	44 mm	90 mm
BI4E2L020	€ 18,90	20 mm	33 mm	44 mm	90 mm
BI4E2L021	€ 18,90	21 mm	35 mm	44 mm	90 mm
BI4E2L022	€ 18,90	22 mm	36 mm	44 mm	90 mm
BI4E2L023	€ 18,90	23 mm	38 mm	44 mm	90 mm
BI4E2L024	€ 18,90	24 mm	39 mm	44 mm	90 mm
BI4E2L025	€ 18,90	25 mm	41 mm	44 mm	90 mm
BI4E2L026	€ 18,90	26 mm	41 mm	44 mm	90 mm
BI4E2L027	€ 18,90	27 mm	42 mm	44 mm	90 mm
BI4E2L028	€ 18,90	28 mm	44 mm	44 mm	90 mm
BI4E2L029	€ 18,90	29 mm	46 mm	44 mm	90 mm
BI4E2L030	€ 18,90	30 mm	46 mm	44 mm	90 mm
BI4E2L032	€ 20,30	32 mm	48 mm	44 mm	90 mm
BI4E2L033	€ 20,30	33 mm	50 mm	44 mm	90 mm
BI4E2L034	€ 20,80	34 mm	52 mm	44 mm	90 mm
BI4E2L035	€ 20,80	35 mm	52 mm	44 mm	90 mm
BI4E2L036	€ 20,80	36 mm	54 mm	44 mm	90 mm
BI4E2L038	€ 24,60	38 mm	56 mm	44 mm	90 mm
BI4E2L041	€ 26,00	41 mm	60 mm	44 mm	90 mm
BI4E2L046	€ 33,80	46 mm	66 mm	44 mm	90 mm
BI4E2L050	€ 42,00	50 mm	71 mm	54 mm	90 mm

PI402X

PROLUNGA AD IMPATTO

DIN 3121 & 3129.



Art.	€	D	Lunghezza
PI402175	€ 30,10	44 mm	175 mm
PI402200	€ 33,20	44 mm	200 mm
PI402300	€ 43,50	44 mm	300 mm
PI402400	€ 61,50	44 mm	400 mm





BI4E1NX

CHIAVE A BUSSOLA AD IMPATTO

DIN 3129.

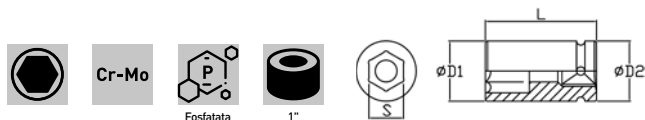

Art.	€	Misura	D1	D2	Lunghezza
BI4E1N021	€ 19,50	21 mm	38 mm	54 mm	58 mm
BI4E1N022	€ 19,50	22 mm	39 mm	54 mm	58 mm
BI4E1N023	€ 19,50	23 mm	41 mm	54 mm	58 mm
BI4E1N024	€ 19,50	24 mm	42 mm	54 mm	58 mm
BI4E1N025	€ 19,50	25 mm	43 mm	54 mm	58 mm
BI4E1N026	€ 19,50	26 mm	44 mm	54 mm	58 mm
BI4E1N027	€ 19,50	27 mm	46 mm	54 mm	58 mm
BI4E1N028	€ 19,50	28 mm	47 mm	54 mm	58 mm
BI4E1N029	€ 19,50	29 mm	48 mm	54 mm	58 mm
BI4E1N030	€ 19,50	30 mm	49 mm	54 mm	62 mm
BI4E1N031	€ 19,50	31 mm	50 mm	54 mm	62 mm
BI4E1N032	€ 19,50	32 mm	52 mm	54 mm	62 mm
BI4E1N033	€ 19,50	33 mm	54 mm	54 mm	62 mm
BI4E1N034	€ 21,60	34 mm	54 mm	54 mm	62 mm
BI4E1N035	€ 21,60	35 mm	54 mm	54 mm	62 mm
BI4E1N036	€ 22,40	36 mm	56 mm	54 mm	65 mm
BI4E1N037	€ 22,90	37 mm	57 mm	54 mm	65 mm
BI4E1N038	€ 25,70	38 mm	58 mm	54 mm	65 mm
BI4E1N039	€ 25,70	39 mm	59 mm	54 mm	65 mm
BI4E1N040	€ 25,70	40 mm	60 mm	54 mm	65 mm
BI4E1N041	€ 25,70	41 mm	61 mm	54 mm	68 mm
BI4E1N042	€ 28,80	42 mm	64 mm	54 mm	68 mm
BI4E1N043	€ 28,80	43 mm	66 mm	54 mm	68 mm
BI4E1N044	€ 28,80	44 mm	66 mm	54 mm	68 mm
BI4E1N045	€ 28,80	45 mm	67 mm	54 mm	68 mm
BI4E1N046	€ 28,80	46 mm	68 mm	54 mm	72 mm
BI4E1N047	€ 32,20	47 mm	69 mm	54 mm	72 mm
BI4E1N048	€ 32,20	48 mm	70 mm	54 mm	72 mm
BI4E1N050	€ 32,20	50 mm	74 mm	54 mm	75 mm
BI4E1N052	€ 40,00	52 mm	75 mm	54 mm	75 mm
BI4E1N054	€ 40,00	54 mm	78 mm	54 mm	80 mm
BI4E1N055	€ 41,50	55 mm	80 mm	54 mm	83 mm
BI4E1N056	€ 44,60	56 mm	81 mm	54 mm	83 mm
BI4E1N060	€ 44,60	60 mm	86 mm	54 mm	87 mm
BI4E1N065	€ 48,60	65 mm	92 mm	54 mm	90 mm
BI4E1N070	€ 54,70	70 mm	97 mm	54 mm	93 mm
BI4E1N075	€ 64,70	75 mm	104 mm	86 mm	95 mm
BI4E1N080	€ 91,10	80 mm	112 mm	86 mm	95 mm
BI4E1N085	€ 105,00	85 mm	115 mm	86 mm	100 mm
BI4E1N090	€ 117,00	90 mm	124 mm	86 mm	105 mm
BI4E1N095	€ 147,00	95 mm	130 mm	86 mm	105 mm
BI4E1N100	€ 182,00	100 mm	135 mm	86 mm	105 mm

BI4E1LX

CHIAVE A BUSSOLA AD IMPATTO LUNGA

DIN 3129.

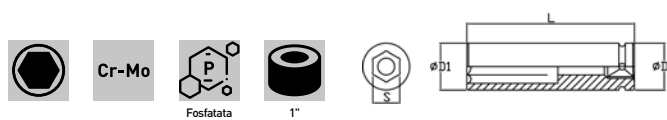

Art.	€	Misura	D1	D2	Lunghezza
BI4E1L021	€ 27,10	21 mm	38 mm	54 mm	90 mm
BI4E1L022	€ 27,10	22 mm	39 mm	54 mm	90 mm
BI4E1L023	€ 27,10	23 mm	41 mm	54 mm	90 mm
BI4E1L024	€ 27,10	24 mm	42 mm	54 mm	90 mm
BI4E1L027	€ 27,10	27 mm	46 mm	54 mm	90 mm
BI4E1L028	€ 27,10	28 mm	47 mm	54 mm	90 mm
BI4E1L030	€ 27,10	30 mm	49 mm	54 mm	90 mm
BI4E1L032	€ 27,10	32 mm	52 mm	54 mm	90 mm
BI4E1L033	€ 27,10	33 mm	54 mm	54 mm	90 mm
BI4E1L034	€ 27,40	34 mm	54 mm	54 mm	90 mm
BI4E1L035	€ 27,60	35 mm	54 mm	54 mm	90 mm
BI4E1L036	€ 27,60	36 mm	56 mm	54 mm	90 mm
BI4E1L038	€ 31,80	38 mm	58 mm	54 mm	95 mm
BI4E1L039	€ 33,30	39 mm	59 mm	54 mm	95 mm
BI4E1L040	€ 33,30	40 mm	60 mm	54 mm	95 mm
BI4E1L041	€ 34,20	41 mm	61 mm	54 mm	95 mm
BI4E1L042	€ 34,20	42 mm	64 mm	54 mm	95 mm
BI4E1L043	€ 36,20	43 mm	66 mm	54 mm	95 mm
BI4E1L044	€ 36,20	44 mm	66 mm	54 mm	95 mm
BI4E1L045	€ 36,90	45 mm	67 mm	54 mm	95 mm
BI4E1L046	€ 36,90	46 mm	68 mm	54 mm	95 mm
BI4E1L048	€ 45,10	48 mm	70 mm	54 mm	100 mm
BI4E1L049	€ 46,60	49 mm	72 mm	54 mm	100 mm
BI4E1L050	€ 46,60	50 mm	74 mm	54 mm	100 mm
BI4E1L051	€ 48,10	51 mm	74 mm	54 mm	100 mm
BI4E1L052	€ 48,90	52 mm	74 mm	54 mm	100 mm
BI4E1L054	€ 48,90	54 mm	78 mm	54 mm	100 mm
BI4E1L055	€ 52,60	55 mm	80 mm	54 mm	105 mm
BI4E1L057	€ 54,80	57 mm	82 mm	54 mm	105 mm
BI4E1L060	€ 72,60	60 mm	86 mm	54 mm	110 mm
BI4E1L065	€ 87,20	65 mm	92 mm	54 mm	115 mm
BI4E1L070	€ 86,90	70 mm	97 mm	54 mm	120 mm
BI4E1L075	€ 127,00	75 mm	104 mm	86 mm	135 mm
BI4E1L080	€ 137,00	80 mm	112 mm	86 mm	135 mm
BI4E1L085	€ 144,00	85 mm	115 mm	86 mm	140 mm
BI4E1L090	€ 189,00	90 mm	124 mm	86 mm	140 mm
BI4E1L095	€ 246,00	95 mm	130 mm	86 mm	140 mm

I340 € 235,00

SERIE BUSSOLE AD IMPATTO, SERIE NORMALE E LUNGHE

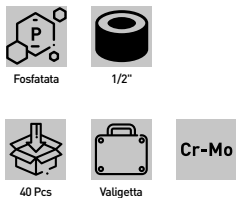

Bussole da 1/2" 9 - 10 - 11 - 12 - 13 - 14 - 15 - 16 - 17 - 18 - 19 - 20 - 21 - 22 - 23 - 24 - 26 - 27 - 30 mm

Bussole lunghe da 1/2" 9 - 10 - 11 - 12 - 13 - 14 - 15 - 16 - 17 - 18 - 19 - 20 - 21 - 22 - 23 - 24 - 26 - 27 - 30 mm

Snodo universale 1/2"

Prolunghe da 1/2" 125 mm

SI413M006 € 51,80

SERIE BUSSOLE ESAGONALI MASCHIO AD IMPATTO

DIN 3129.

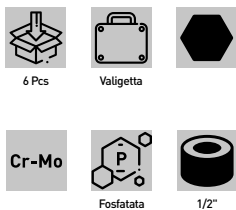

Bussole 8, 10, 12, 14, 17, 19 mm

Lunghezza 60 mm

0341-X

CHIAVI BUSSOLA ESAGONALI IMPACT RIVESTITE IN PLASTICA

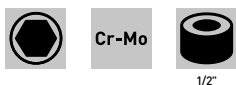

Art.	€	Misura	Lunghezza
0341/17	€ 8,80	17 mm	87 mm
0341/19	€ 8,80	19 mm	87 mm
0341/21	€ 8,80	21 mm	87 mm
0341/22	€ 10,90	22 mm	87 mm
0341/24	€ 12,40	24 mm	87 mm

SI4E3N013 € 59,30

SERIE BUSSOLE AD IMPATTO, SERIE NORMALE

DIN 3129

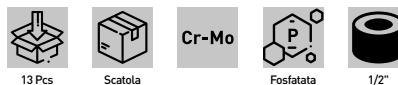
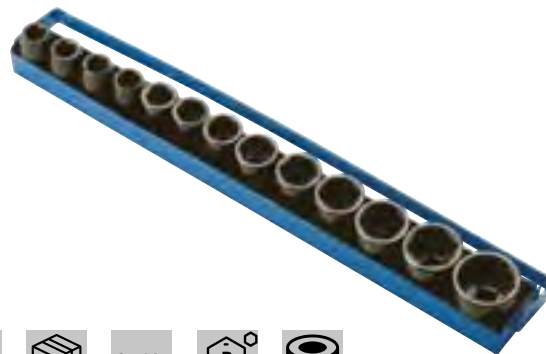

Bussole 10, 11, 12, 13, 14, 16, 17, 19, 21, 22, 24, 27, 30 mm

SI423M006 € 59,30

SERIE BUSSOLE TORX MASCHIO AD IMPATTO

DIN 3129.

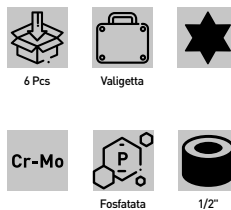

Lunghezza 60 mm

Bussole T40, T45, T50, T55, T60, T70

0341 € 36,90

SERIE CHIAVI BUSSOLA ESAGONALI IMPACT RIVESTITE IN PLASTICA

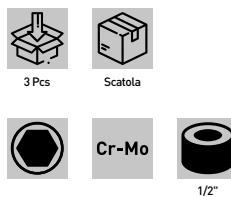

Misure 17 - 19 - 21 mm
Lunghezza 87 mm



0341/5S € 51,80

SERIE CHIAVI BUSSOLA ESAGONALI IMPACT RIVESTITE IN PLASTICA



5 Pcs



Scatola



Cr-Mo



1/2"

Misure	17 - 19 - 21 - 22 - 24 mm
Lunghezza	87 mm

0341/3LS € 56,90

SERIE CHIAVI BUSSOLA ESAGONALI IMPACT RIVESTITE IN PLASTICA



3 Pcs



Scatola



Cr-Mo



1/2"

Misure	17 - 19 - 21 mm
Lunghezza	150 mm

I306 **PRO** € 70,50

SERIE CHIAVI A BUSSOLA LUNGHE AD IMPATTO



3 Pcs



Scatola



Cr-Mo



Cromata



1/2"

Misure	17 - 19 - 21 mm
Lunghezza	150 mm

0341-XL

CHIAVI BUSSOLA LUNGHE ESAGONALI IMPACT RIVESTITE IN PLASTICA



Cr-Mo



1/2"

Art.	€	Misura	Lunghezza
0341/17L	€ 17,20	17 mm	150 mm
0341/19L	€ 17,20	19 mm	150 mm
0341/21L	€ 17,20	21 mm	150 mm

0341-SX

RIVESTIMENTO IN PLASTICA PER BUSSOLE IMPACT



Plastic

Art.	€	Misura
0341/S17	€ 1,03	17 mm
0341/S19	€ 1,03	19 mm
0341/S21	€ 1,03	21 mm
0341/S22	€ 1,03	22 mm
0341/S24	€ 1,03	24 mm

I217 € 310,00

SERIE BUSSOLE AD IMPATTO, SERIE NORMALE



17 Pcs



Valigetta



Cr-Mo



Fosfatata



3/4"

Misure	19 - 21 - 22 - 24 - 27 - 30 - 32 - 33 - 34 - 35 - 36 - 38 - 40 - 41 - 46 - 50 - 55 mm
--------	---

SI4E2N008

€ 110,00

SERIE BUSSOLE AD IMPATTO, SERIE NORMALE

DIN 3129.



Bussole 26, 27, 29, 30, 32, 35, 36, 38 mm

SI4E1N008

€ 162,00

SERIE BUSSOLE AD IMPATTO, SERIE NORMALE

DIN 3129.

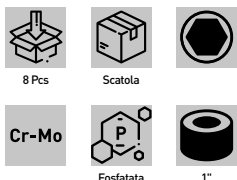

Bussole 24, 27, 30, 32, 33, 36, 38, 41 mm

PI401X

PROLUNGA AD IMPATTO

DIN 3121 & 3129.



Art.	€	D	Lunghezza
PI401175	€ 41,40	54 mm	175 mm
PI401200	€ 44,50	54 mm	200 mm
PI401250	€ 53,80	54 mm	250 mm
PI401300	€ 57,30	54 mm	300 mm
PI401400	€ 72,60	54 mm	400 mm

SNODO A CARDANO AD IMPATTO

Con attacco quadro maschio e femmina, costruito in acciaio legato 42crmo2

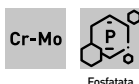

Art.	€	Attacco quadro	D	Lunghezza
JI401N	€ 84,70	1"	54 mm	115 mm
JI402N	€ 53,00	3/4"	44 mm	90 mm
JI403N	€ 22,40	1/2"	30 mm	63 mm

I109

€ 177,00

SERIE BUSSOLE AD IMPATTO

DIN 3129.



Bussole da 1" 21 - 22 - 24 - 26 - 30 - 38 mm
Bussole lunghe da 1" 27 - 28 - 32 mm

SI40N006

€ 37,30

SERIE RACCORDI AD IMPATTO

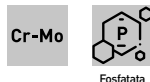

Misure 1/4" int. - 3/8" ext.; 3/8" int. - 1/4" ext.; 3/8" int. - 1/2" ext.; 1/2" int. - 3/8" ext.; 1/2" int. - 3/4"
Valigetta in plastica 126 x 100 x 52 mm

JI40XL

SNODO A CARDANO AD IMPATTO

Serie pesante, con attacco quadro maschio e femmina, costruito in acciaio legato 42CRMO2.

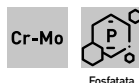

Art.	€	Attacco quadro	Lunghezza	D
JI401L	€ 84,70	1"	130 mm	54 mm
JI402L	€ 53,00	3/4"	105 mm	44 mm

RI40X

RACCORDO AD IMPATTO

DIN 3121

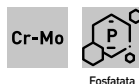

Art.	€	Attacco femmina	Attacco maschio	D	Lunghezza
RI4012N	€ 19,70	1"	3/4"	54 mm	70 mm
RI4021N	€ 15,70	3/4"	1"	44 mm	63 mm
RI4023N	€ 12,20	3/4"	1/2"	44 mm	58 mm
RI4032N	€ 8,70	1/2"	3/4"	30 mm	48 mm



0088 € 17,20

ESTRATTORE MAGNETICO FLESSIBILE LUMINOSO



Misure $\varnothing 9 / 17 \times 430$ mm
Batterie non incluse 2 x 1.5 VAA

0456 € 5,90

SERIE GANCI PER OR

Dotato di manico esagonale con magnete

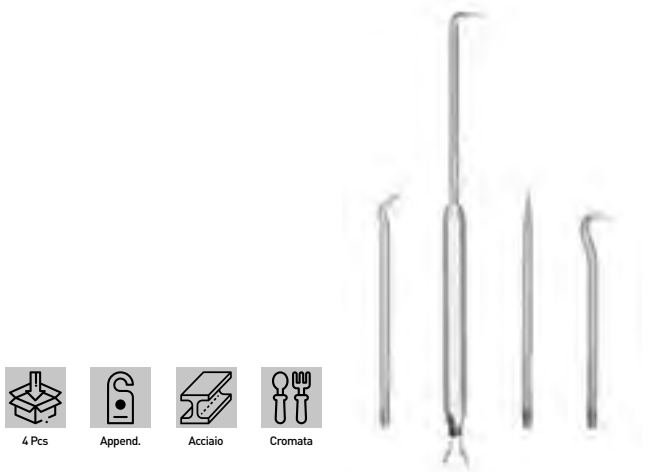

Dimensioni manico 8 x 90 mm

E001 € 14,10

SERIE ESTRATTORI PER VITI



num. 1	M3 - M6
num. 2	M6 - M8
num. 3	M8 - M11
num. 4	M11 - M14
num. 5	M14 - M18

0471 € 5,90

SERIE GANCI PER RIMOZIONE OR

Ganci adatti anche per rimozioni guarnizioni su motori



Lunghezza 135 mm

E003 € 21,50

SERIE ESTRATTORI IN HSS



num. 0	2-3 mm
num. 1	4-5 mm
num. 2	6-8 mm
num. 3	8-10 mm
num. 4	10-12 mm

E005 € 35,20

SERIE DI ESTRATTORI

Per dadi e bulloni con esagono esterno



Misure Altezza 9 - 10 - 11 - 12 - 13 - 14 - 15 - 16 - 17 - 19 mm
27 mm

E191-

ESTRATTORE A 3 GRIFFE



Art.	€	Dimensioni
E191/120	€ 57,60	Max Ø 120 mm - h 101 mm
E191/200	€ 108,00	Max Ø 200 mm - h 150 mm

E190-

ESTRATTORE A 2 GRIFFE



Art.	€	Dimensioni
E190/080	€ 30,00	Max Ø 80 mm - h 100 mm
E190/130	€ 39,20	Max Ø 130 mm - h 100 mm
E190/160	€ 48,20	Max Ø 160 mm - h 150 mm
E190/200	€ 52,00	Max Ø 200 mm - h 150 mm

E190-BX

GRIFFA PROLUNGATA



Art.	€	Lunghezza
E190/B2	€ 28,80	300 mm

**CB01-****CHIAVE A BUSSOLA CON IMPUGNATURA**

Ansi, con foro profondo



Art.	€	Misura	L	L1	L2	L3	L4	A	B	C
CB01/04	€ 5,80	4 mm	185 mm	75 mm	4 ~ 5 mm	20,5 mm	110 mm	ø 5,9 mm	ø 7 mm	ø 3,3 mm
CB01/05	€ 5,80	5 mm	185 mm	75 mm	4,5 ~ 5,5 mm	20 mm	110 mm	ø 5,9 mm	ø 8,3 mm	ø 3,7 mm
CB01/055	€ 5,80	5,5 mm	185 mm	75 mm	5,5 ~ 6,5 mm	19 mm	110 mm	ø 5,9 mm	ø 9 mm	ø 3,7 mm
CB01/06	€ 5,80	6 mm	185 mm	75 mm	6,5 ~ 7,5 mm	18 mm	110 mm	ø 5,9 mm	ø 9,5 mm	ø 3,7 mm
CB01/07	€ 6,20	7 mm	185 mm	75 mm	7,5 ~ 8,5 mm	17 mm	110 mm	ø 5,9 mm	ø 10,5 mm	ø 3,7 mm
CB01/08	€ 6,20	8 mm	185 mm	75 mm	8,5 ~ 9,5 mm	16 mm	110 mm	ø 7,2 mm	ø 11,9 mm	ø 5 mm
CB01/09	€ 6,20	9 mm	185 mm	75 mm	8,5 ~ 9,5 mm	16 mm	110 mm	ø 7,2 mm	ø 12,8 mm	ø 5 mm
CB01/10	€ 6,70	10 mm	185 mm	75 mm	10,5 ~ 11,5 mm	14 mm	110 mm	ø 9,3 mm	ø 14,1 mm	ø 7 mm
CB01/11	€ 6,70	11 mm	185 mm	75 mm	10,5 ~ 11,5 mm	14 mm	110 mm	ø 9,3 mm	ø 15 mm	ø 7 mm
CB01/12	€ 6,70	12 mm	185 mm	75 mm	10,5 ~ 11,5 mm	14 mm	110 mm	ø 9,3 mm	ø 16 mm	ø 7 mm
CB01/13	€ 6,70	13 mm	185 mm	75 mm	11,5 ~ 12,5 mm	14 mm	110 mm	ø 11 mm	ø 17 mm	ø 8,5 mm

CB02-**CHIAVE A BUSSOLA CON IMPUGNATURA**

Ansi, con foro profondo



Art.	€	Misura	L	L1	L2	L3	L4	A	B	C
CB02/04	€ 7,30	4 mm	185 mm	75 mm	4 ~ 5 mm	105,5 mm	110 mm	ø 7,2 mm	ø 7 mm	ø 3,3 mm
CB02/05	€ 7,30	5 mm	185 mm	75 mm	4,5 ~ 5,5 mm	105 mm	110 mm	ø 7,2 mm	ø 8,3 mm	ø 3,7 mm
CB02/055	€ 7,30	5,5 mm	185 mm	75 mm	5,5 ~ 6,5 mm	104 mm	110 mm	ø 7,2 mm	ø 9 mm	ø 3,7 mm
CB02/06	€ 7,30	6 mm	185 mm	75 mm	6,5 ~ 7,5 mm	103 mm	110 mm	ø 7,2 mm	ø 9,5 mm	ø 3,7 mm
CB02/07	€ 7,70	7 mm	185 mm	75 mm	7,5 ~ 8,5 mm	102 mm	110 mm	ø 7,2 mm	ø 10,5 mm	ø 3,7 mm
CB02/08	€ 7,70	8 mm	185 mm	75 mm	8,5 ~ 9,5 mm	101 mm	110 mm	ø 9,3 mm	ø 11,9 mm	ø 5 mm
CB02/09	€ 7,70	9 mm	185 mm	75 mm	8,5 ~ 9,5 mm	101 mm	110 mm	ø 9,3 mm	ø 12,8 mm	ø 5 mm
CB02/10	€ 7,70	10 mm	185 mm	75 mm	10,5 ~ 11,5 mm	100 mm	110 mm	ø 9,3 mm	ø 14,1 mm	ø 7 mm
CB02/11	€ 8,70	11 mm	185 mm	75 mm	10,5 ~ 11,5 mm	100 mm	110 mm	ø 11 mm	ø 15 mm	ø 7 mm
CB02/12	€ 8,70	12 mm	185 mm	75 mm	10,5 ~ 11,5 mm	100 mm	110 mm	ø 11 mm	ø 16 mm	ø 7 mm
CB02/13	€ 9,60	13 mm	185 mm	75 mm	11,5 ~ 12,5 mm	99 mm	110 mm	ø 11 mm	ø 17 mm	ø 8,5 mm

CBF1-**CHIAVE A BUSSOLA FLESSIBILE CON IMPUGNATURA**

Ansi



Art.	€	Misura	L	L1	L2	L3	A	B
CBF1/05	€ 7,30	5 mm	265 mm	150 mm	9,5 mm	115 mm	ø 11 mm	ø 11,8 mm
CBF1/055	€ 7,30	5,5 mm	265 mm	150 mm	9,5 mm	115 mm	ø 11 mm	ø 11,8 mm
CBF1/06	€ 7,30	6 mm	265 mm	150 mm	9,5 mm	115 mm	ø 11 mm	ø 11,8 mm
CBF1/07	€ 7,30	7 mm	265 mm	150 mm	9,5 mm	115 mm	ø 11 mm	ø 11,8 mm
CBF1/08	€ 7,30	8 mm	265 mm	150 mm	9,5 mm	115 mm	ø 11 mm	ø 11,8 mm
CBF1/09	€ 7,40	9 mm	265 mm	150 mm	9,5 mm	115 mm	ø 11 mm	ø 13 mm
CBF1/10	€ 7,70	10 mm	265 mm	150 mm	10 mm	115 mm	ø 11 mm	ø 14,5 mm
CBF1/11	€ 8,20	11 mm	265 mm	150 mm	9 mm	115 mm	ø 11 mm	ø 15,9 mm
CBF1/12	€ 8,20	12 mm	265 mm	150 mm	9 mm	115 mm	ø 11 mm	ø 17 mm
CBF1/13	€ 8,20	13 mm	265 mm	150 mm	8,5 mm	115 mm	ø 11 mm	ø 17,8 mm



CBF1/10P

€ 71,20

SERIE CHIAVI A BUSSOLA FLESSIBILI CON IMPUGNATURA

Ansi, bicomponente



Misure 5 - 5.5 - 6 - 7 - 8 - 9 - 10 - 11 - 12 - 13 mm

CB01/04P

€ 26,40

SERIE CHIAVI A BUSSOLA CON IMPUGNATURA

Ansi, bicomponente



Misure 10 - 11 - 12 - 13 mm

CB01/07P

€ 40,40

SERIE CHIAVI A BUSSOLA CON IMPUGNATURA

Ansi, bicomponente



Misure 4 - 5 - 5.5 - 6 - 7 - 8 - 9 mm

CB01/11P

€ 65,40

SERIE CHIAVI A BUSSOLA CON IMPUGNATURA

Ansi, bicomponente



Misure 4 - 5 - 5.5 - 6 - 7 - 8 - 9 - 10 - 11 - 12 - 13 mm

CB02/04P

€ 33,70

SERIE CHIAVI A BUSSOLA CON IMPUGNATURA

Ansi, bicomponente con foro profondo



Misure 10 - 11 - 12 - 13 mm

CB02/07P

€ 52,80

SERIE CHIAVI A BUSSOLA CON IMPUGNATURA

Ansi, bicomponente con foro profondo



Misure 4 - 5 - 5.5 - 6 - 7 - 8 - 9 - 10 mm

CB02/11P

€ 85,60

SERIE CHIAVI A BUSSOLA CON IMPUGNATURA

Ansi, bicomponente con foro profondo



Misure 4 - 5 - 5.5 - 6 - 7 - 8 - 9 - 10 - 11 - 12 - 13 mm



DIN 2380-1, con lama nera e manico tricomponente realizzato in resina TPR altamente elastica e materiale polipropilene resistente all'olio. La punta diamantata consente una perfetta presa evitando di rovinare la testa della vite. Questa tipologia di punta è anche molto efficace con viti già rovinate.



D883- PRO

GIRAVITE A TAGLIO ELETTRICISTA CON PUNTA DIAMANTATA

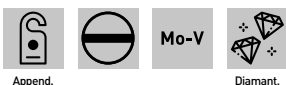

Art.	€	Misura	Lunghezza asta	Lunghezza totale
D883/3075	€ 2,98	3 mm	75 mm	115 mm
D883/4100	€ 4,04	4 mm	100 mm	145 mm

D884/6038 PRO € 3,75

GIRAVITE A TAGLIO CON PUNTA DIAMANTATA

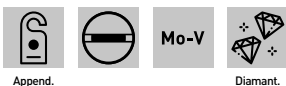

Misura	6 mm
Lunghezza asta	38 mm
Lunghezza totale	70 mm

D882/2038 PRO € 3,84

GIRAVITE A CROCE PH CON PUNTA DIAMANTATA



Misura	PH 2
Lunghezza asta	38 mm
Lunghezza totale	70 mm

D885/2038 PRO € 3,75

GIRAVITE A CROCE PZ CON PUNTA DIAMANTATA



Misura	PZ 2
Lunghezza asta	38 mm
Lunghezza totale	70 mm

D884- PRO

GIRAVITE A TAGLIO CON PUNTA DIAMANTATA

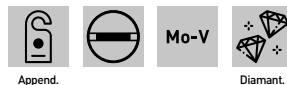

Art.	€	Misura	Lunghezza asta	Lunghezza totale
D884/3075	€ 3,17	3 mm	75 mm	115 mm
D884/4100	€ 3,84	4 mm	100 mm	145 mm
D884/5125	€ 4,33	5 mm	125 mm	170 mm
D884/6150	€ 5,00	6 mm	150 mm	200 mm
D884/8150	€ 6,10	8 mm	150 mm	210 mm

D882- PRO

GIRAVITE A CROCE PH CON PUNTA DIAMANTATA



Art.	€	Misura	Lunghezza asta	Lunghezza totale
D882/1075	€ 4,33	PH 1	75 mm	120 mm
D882/2100	€ 5,60	PH 2	100 mm	150 mm
D882/3150	€ 6,30	PH 3	150 mm	210 mm

D885- PRO

GIRAVITE A CROCE PZ CON PUNTA DIAMANTATA



Art.	€	Misura	Lunghezza asta	Lunghezza totale
D885/1075	€ 4,33	PZ 1	75 mm	120 mm
D885/2100	€ 5,50	PZ 2	100 mm	150 mm
D885/3150	€ 6,30	PH 3	10 mm	210 mm

D880/006 PRO € 23,90

SERIE GIRAVITI DIAMANTATI

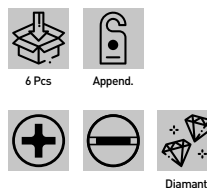

Misure Taglio	(-) 4 x 100 mm, (-) 5 x 125 mm, (-) 6 x 150 mm
Croce	(+) PH 1 x 75 mm, (+) PH 2 x 100 mm, (+) PH 3 x 150 mm

C883-
GIRAVITE ELETTRICISTA, APPENDIBILE

A taglio, con punta magnetica fosfatata nera diritta e manico realizzato in resina TPR altamente elastica e materiale polipropilene resistente all'olio

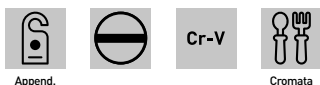

Art.	€	Misura	Lunghezza asta
C883/3075	€ 1,73	3 mm	75 mm
C883/4100	€ 2,55	4 mm	100 mm

C884-
GIRAVITE A TAGLIO, APPENDIBILE

Con punta magnetica fosfatata nera e manico realizzato in resina TPR altamente elastica e materiale polipropilene resistente all'olio.

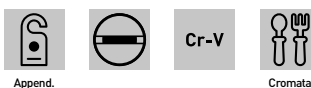

Art.	€	Misura	Lunghezza asta
C884/3075	€ 1,73	3 mm	75 mm
C884/4100	€ 2,67	4 mm	100 mm
C884/5125	€ 3,17	5 mm	125 mm
C884/6150	€ 3,56	6 mm	150 mm
C884/8150	€ 4,15	8 mm	150 mm

C884/6038
€ 2,77
GIRAVITE A TAGLIO, APPENDIBILE

Con punta magnetica fosfatata nera e manico realizzato in resina TPR altamente elastica e materiale polipropilene resistente all'olio.

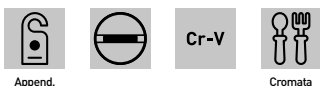

Misura	6 mm
Lunghezza asta	38 mm

C882-
GIRAVITE A CROCE PH, APPENDIBILE

Con punta magnetica fosfatata nera e manico realizzato in resina TPR altamente elastica e materiale polipropilene resistente all'olio



Art.	€	Misura	Lunghezza asta
C882/1075	€ 3,17	PH 1	75 mm
C882/2100	€ 4,15	PH 2	100 mm
C882/3150	€ 4,42	PH 3	150 mm

C882/2038
€ 2,77
GIRAVITE A CROCE PH, APPENDIBILE

Con punta magnetica fosfatata nera e manico realizzato in resina TPR altamente elastica e in polipropilene resistente all'olio



Misura	PH 2
Lunghezza asta	38 mm

C885-
GIRAVITE A CROCE PZ, APPENDIBILE

Con punta magnetica fosfatata nera e manico realizzato in resina TPR altamente elastica e materiale polipropilene resistente all'olio



Art.	€	Misura	Lunghezza asta
C885/1075	€ 3,17	PZ 1	75 mm
C885/2100	€ 4,15	PZ 2	100 mm
C885/3150	€ 4,42	PZ 3	150 mm



C885/2038 € 2,77

GIRAVITE A CROCE PZ, APPENDIBILE

Con punta magnetica fosfatata nera e manico realizzato in resina TPR altamente elastica e materiale polipropilene resistente all'olio.



Misura	PZ 2
Lunghezza asta	38 mm

C880/006 € 16,20

SERIE GIRAVITI

Con punta magnetica fosfatata nera e manico realizzato in resina TPR altamente elastica e materiale polipropilene resistente all'olio.

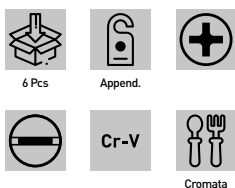

Misure Taglio	(-) 4 x 100 mm, (-) 5 x 125 mm, (-) 6 x 150 mm
Croce	(+) PH 1 x 75 mm, (+) PH 2 x 100 mm, (+) PH 3 x 150 mm

0887 € 36,10

SERIE GIRAVITI EXTRA LUNGI INTERCAMBIABILI

9 doppie lame con torx con foro e torx di sicurezza a 5 punte con foro

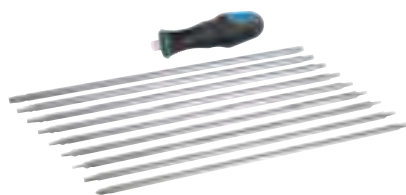

Torx con foro	T10 - T15 - T20 - T25 - T27 - T30 - T40
Torx 5 punte con foro	TS10 - TS15 - TS20 - TS25 - TS27 - TS30 - TS40
Taglio	4 - 5 mm
Lunghezza	300 mm

C881- **NEW**

GIRAVITE TORX, APPENDIBILE

Con punta magnetica fosfatata nera e manico realizzato in resina TPR altamente elastica e materiale polipropilene resistente all'olio.



Art.	€	Misure
C881/07075	€ 1,15	T7x75mm
C881/08075	€ 1,15	T8x75mm
C881/10075	€ 1,15	T10x75mm
C881/15100	€ 1,68	T15x100mm
C881/20100	€ 1,68	T20x100mm
C881/25125	€ 1,84	T25x125mm
C881/27125	€ 1,84	T27x125mm
C881/30150	€ 2,39	T30x150mm
C881/35150	€ 2,87	T35x150mm
C881/40150	€ 2,87	T40x150mm

C881/006 **NEW** € 10,50

SERIE GIRAVITI TORX

Con punta magnetica fosfatata nera e manico realizzato in resina TPR altamente elastica e materiale polipropilene resistente all'olio.

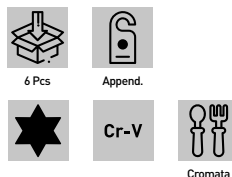

Misure torx	T10x75mm, T15x100mm, T20x100mm, T25x125mm, T27x125mm, T30x150mm
-------------	---

0633 € 15,10

SERIE GIRAVITI A LAME PASSANTI

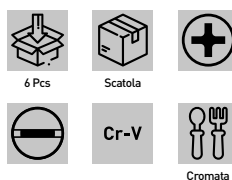

Misure Taglio	(-) 5,0x1,0x75 mm, (-) 6,0x1,2x100 mm, (-) 6,0x1,2x125 mm, (-) 8,0x1,2x150 mm
Croce	(+) PH 1x5x75 mm, (+) PH 2x6x100 mm



0634 € 11,90

SERIE GIRAVITI

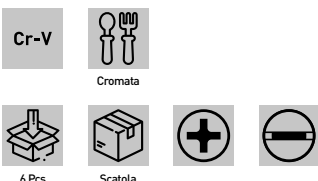

Misure Taglio (-) 4x0,8x75 mm, (-) 5,5x1,0x100 mm, (-) 6,5x1,2x150 mm
Croce (+) PH 0x3x75 mm, (+) PH 1x5x100 mm, (+) PH 2x6x125 mm

0880/307 € 19,40

SERIE GIRAVITI

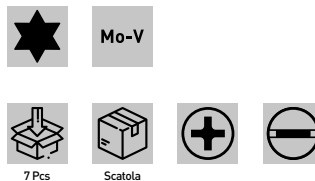

Taglio (-) 3,0x0,5x75 mm, (-) 4,0x0,8x100 mm, (-) 5,5x1,0x125 mm, (-) 6,5x1,2x150 mm, (-) 8,0x1,2x150 mm
Croce (+) PH 1x80 mm, (+) PH 2x100 mm

0881/008 € 16,20

SERIE GIRAVITI TORX



Torx T 7x60 - T 8x60 - T 9x60 - T 10x80 - T 15x80 - T 20x100 - T 25x100 - T 30x115 mm

C182- **PRO**

GIRAVITE A CROCE ISOLATO

1000V IEC 60900, con punta magnetica fosfatata nera e manico bi-colore in polipropilene resistente all'olio.



Art.	€	Misura	Lunghezza asta	Lunghezza totale
C182/0060	€ 2,88	PH0 x 3 mm	60 mm	160 mm
C182/1080	€ 3,75	PH1 x 4.5 mm	80 mm	185 mm
C182/2100	€ 4,42	PH2 x 6 mm	100 mm	210 mm
C182/3150	€ 7,30	PH3 x 8 mm	150 mm	265 mm

C183- **PRO**

GIRAVITE A TAGLIO ISOLATO

1000V IEC 60900, con punta magnetica fosfatata nera e manico bi-colore in polipropilene resistente all'olio.



Art.	€	Misura	Lunghezza asta	Lunghezza totale
C183/25075	€ 2,88	0.4 x 2.5 mm	75 mm	175 mm
C183/30100	€ 3,75	0.6 x 3 mm	100 mm	200 mm
C183/40100	€ 3,75	0.8 x 4 mm	100 mm	200 mm
C183/55125	€ 4,04	1 x 5.5 mm	125 mm	230 mm
C183/65150	€ 5,30	1.2 x 6.5 mm	150 mm	260 mm
C183/80175	€ 7,00	1.6 x 8 mm	175 mm	290 mm

C180/006 **PRO** € 21,70

SERIE GIRAVITI ISOLATI

1000V IEC 60900, con punta magnetica fosfatata nera e manico bi-colore in polipropilene resistente all'olio.

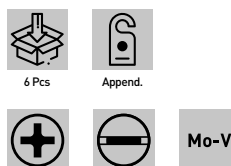

Misure Taglio (-) 0,6 x 3 x 100 mm, (-) 0,8 x 4 x 100 mm, (-) 1 x 5,5 x 125 mm
Croce (+) PH 0 x 3 x 60 mm, (+) PH 1 x 4,5 x 80 mm, (+) PH 2 x 6 x 100 mm

**0355**

€ 18,80

SERIE GIRAVITI ELETTRICISTA

7 Pcs



Scatola



Cr-Mo

Misure Taglio (-) 0,4x2,5x85 mm, (-) 0,8x4,0x100 mm, (-) 1,0x5,5x125 mm, (-) 1,2x6,5x150 mm
Croce (+) PH 0x75 mm, (+) PH 1x100 mm, (+) PH 2x100 mm

P883-**PRO****GIRAVITE DI PRECISIONE A TAGLIO**

DIN 2380-1, con punta magnetica brunita, impugnatura in materiale bicomponente con parte terminale libera di ruotare per un perfetto grip



Cr-V



Fosfatata

Art.	€	Misura	Lunghezza asta	Lunghezza totale
P883/1250	€ 2,69	1,2 mm	50 mm	140 mm
P883/1650	€ 2,69	1,6 mm	50 mm	140 mm
P883/1850	€ 2,69	1,8 mm	50 mm	140 mm
P883/2050	€ 2,69	2,0 mm	50 mm	140 mm
P883/2450	€ 2,69	2,4 mm	50 mm	140 mm
P883/3050	€ 2,69	3,0 mm	50 mm	140 mm
P883/3550	€ 2,69	3,5 mm	50 mm	140 mm
P883/4050	€ 2,69	4,0 mm	50 mm	140 mm

P881-**PRO****GIRAVITE DI PRECISIONE TORX**

Con punta magnetica brunita, impugnatura in materiale bicomponente con parte terminale libera di ruotare per un perfetto grip.



Cr-V



Fosfatata

Art.	€	Misura	Lunghezza asta	Lunghezza totale
P881/0550	€ 2,69	T5	50 mm	140 mm
P881/0650	€ 2,69	T6	50 mm	140 mm
P881/0750	€ 2,69	T7	50 mm	140 mm
P881/0850	€ 2,69	T8	50 mm	140 mm
P881/0950	€ 2,69	T9	50 mm	140 mm
P881/1050	€ 2,69	T10	50 mm	140 mm
P881/1550	€ 2,69	T15	50 mm	140 mm

0083

€ 11,30

GIRAVITE A PERCUSSIONE

Fornito in astuccio di plastica



7 Pcs



Scatola



Acciaio



Satinata

Dimensioni 165 x 42 mm
Inserti 6
Attacco 5/16"

P882-**PRO****GIRAVITE DI PRECISIONE PH**

DIN 8764, con punta magnetica brunita, impugnatura in materiale bicomponente con parte terminale libera di ruotare per un perfetto grip



Cr-V



Fosfatata

Art.	€	Misura	Lunghezza asta	Lunghezza totale
P882/0150	€ 2,69	PH 1	50 mm	140 mm
P882/1050	€ 2,69	PH 0	50 mm	140 mm
P882/2050	€ 2,69	PH 00	50 mm	140 mm

P886-**PRO****GIRAVITE DI PRECISIONE ESAGONALE**

DIN ISO 2936, con punta magnetica brunita, impugnatura in materiale bicomponente con parte terminale libera di ruotare per un perfetto grip



Cr-V



Fosfatata

Art.	€	Misura	Lunghezza asta	Lunghezza totale
P886/1350	€ 2,69	1,3 mm	50 mm	140 mm
P886/1550	€ 2,69	1,5 mm	50 mm	140 mm
P886/2050	€ 2,69	2,0 mm	50 mm	140 mm
P886/2550	€ 2,69	2,5 mm	50 mm	140 mm
P886/3050	€ 2,69	3,0 mm	50 mm	140 mm



P880/06S **PRO** € 14,90

SERIE GIRAVITI DI PRECISIONE

Con punta magnetica brunita, impugnatura in materiale bicomponente con parte terminale libera di ruotare per un perfetto grip.



Taglio 1.2 x 50 mm, 2.0 x 50 mm, 3.0 x 50 mm
Croce PH 00 x 50 mm, PH 0 x 50 mm, PH 1 x 50 mm

P881/06S **PRO** € 14,90

SERIE GIRAVITI DI PRECISIONE TORX

Con punta magnetica brunita, impugnatura in materiale bicomponente con parte terminale libera di ruotare per un perfetto grip.



Torx T5 x 50 mm, T6 x 50 mm, T7 x 50 mm, T8 x 50 mm, T9 x 50 mm, T10

0245 € 10,70

SERIE GIRAVITI DI PRECISIONE



Croce 00x50 - 0x50 mm
Taglio 1,5x50 - 2x50 - 2,5x50 - 3x50 mm

0207 € 14,40

SERIE DI MINI GIRAVITI CON DOPPIA LAMA

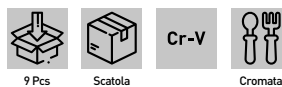

Lunghezza lama 110 mm
Lunghezza manico 170 mm

0829 € 6,00

SERIE GIRAVITI E CHIAVI DI PRECISIONE



0082 € 1,47

SERIE GIRAVITI PRECISIONE



4 a taglio 4 Pcs 1,4x20 mm - 2x23 mm - 2,4x24 mm - 3x27 mm
2 a croce 2 Pcs PH 1x30 mm - PH 0x25 mm

0466/DM € 1,93

MAGNETIZZATORE/DEMAGNETIZZATORE PER GIRAVITI



Dimensioni 52 x 50 x 28.5 mm

0888 € 21,60

PORTA INSERTI AD ANGOLO 90°

Manico porta bit





PIF1 € 8,20

PORTA INSERTI FLESSIBILE MAGNETICO



L	265 mm
L1	150 mm
L2	9,5 mm
L3	115 mm
A	10 mm
B	11,8 mm



0562N **PRO NEW** € 4,64

PORTA INSERTI MAGNETICO NANO

Manico tricomponente realizzato in resina TPR altamente elastica e materiale polipropilene resistente all'olio.

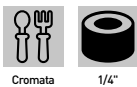

Lunghezza	110 mm
-----------	--------



0548 € 12,50

PORTA INSERTO A CRICCHETTO

Porta inserti corto a cricchetto reversibile, con un inserto, di dimensioni molto ridotte per avvitare e svitare in poco spazio



Dimensioni	ø 29 x 60 mm
------------	--------------



0407 € 3,84

PORTA INSERTI

Con impugnatura dritta e a 90°, utile ad agevolare il lavoro in piccoli spazi



Lunghezza	105 mm
Phillips	1 - 2
Pozzi-driv	1 - 2
Taglio	2 - 3 - 4 mm



0562 **PRO NEW** € 5,70

PORTA INSERTI MAGNETICO

Manico tricomponente realizzato in resina TPR altamente elastica e materiale polipropilene resistente all'olio.



Lunghezza	200 mm
-----------	--------



0304 € 6,90

PORTA INSERTI MAGNETICO



0406 € 3,47

PORTA INSERTI ESAGONALI A CAMBIO RAPIDO



Lunghezza	60 mm
-----------	-------



0089 € 1,79

SERIE INSERTI



Phillips	1 - 2
Pozzi-driv	1 - 2
Taglio	4 - 6 mm



0358

€ 30,80

SERIE INSERTI, BUSSOLE E PORTA INSERTI



Inserti	
Phillips	0 - 1 - 2 (x5 Pz/Pcs) - 3
Pozi-driv	0 - 1 - 2 (x5 Pz/Pcs) - 3
Taglio	3 - 4 - 4,5 - 5 - 5,5 - 6 - 6,5 - 7 - 8 mm
Spanner	4 - 6 - 8 - 10
Torx	8 - 10 - 15 - 20 - 25 - 27 - 30 - 40 - 45
Triplay	1 - 2 - 3 - 4
Torx con foro	8 - 10 - 15 - 20 - 25 - 27 - 30 - 35 - 40
Torq-set	6 - 8 - 10
Esagonali metrici	1,5 - 2 - 2,5 - 3 - 4 - 5 - 5,5 - 6 - 8 mm
Robertson	0 - 1 - 2 - 3
Esagonali pollici	1/16 - 5/64 - 3/32 - 7/64 - 1/8 - 9/64 - 5/32 - 3/16 - 7/32 - XZN M5 - M6 - M8
Esagonali con foro	2 - 2,5 - 3 - 4 - 5 - 6 - 5/64 - 3/32 - 7/64 - 1/8 - 9/64 - 5/32
Clutch	1 - 2 - 3
Adattatore maschio con quadro da 1/4" e esagono da 1/4"	25 mm

Adattatore maschio con quadro da 1/4" e esagono da 1/4"	50 mm
Inserto a "Y"	1 Pz
Adattatore inserti	1 Pz
Porta inserti magnetico	60 mm
Porta inserti	1 Pz
Inserti a bussola	4 - 5 - 6 - 7 - 8 - 9 - 10 - 11 - 12 - 13 - 5/32 - 3/13 - 7/32 -

0626L

€ 20,70

SERIE INSERTI LUNGI

Con porta inserto magnetico

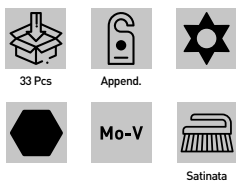

Lunghezza	50 mm
Inserti	
Torx con foro	T7 - T8 - T10 - T15 - T20 - T25 - T30 - T35 - T40
Esagonali con foro	6 - 5 - 4 - 3 - 2,5 - 2 mm
Esagonali con foro	5/32 - 9/64 - 1/8 - 7/64 - 3/32 - 5/64
Spanner	4 - 6 - 8 - 10
Torq-set	6 - 8 - 10
Tri-wing	1 - 2 - 3 - 4

0626

€ 9,30

SERIE INSERTI

Con porta inserto magnetico

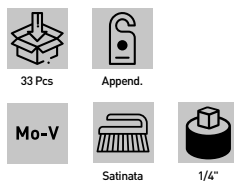

Inserti	
Torx	T7 - T8 - T10 - T15 - T20 - T25 - T30 - T35 - T40
Esagonali	
Metrici	6 - 5 - 4 - 3 - 2,5 - 2 mm
Pollici	5/32 - 9/64 - 1/8 - 7/64 - 3/32 - 5/64
Spanner	4 - 6 - 8 - 10
Torq-set	6 - 8 - 10
Tri-wing	1 - 2 - 3 - 4

PI063

NEW € 25,80

KIT PORTA INSERTI MULTIUSO PER RIPARAZIONI

Kit di 62 inserti più manico magnetizzato con tappo girevole per la riparazione di precisione dei tuoi apparecchi, inclusi smartphones, orologi ed elettrodomestici. La scatola porta inserti magnetizzata e la funzione click-clack, consentono di mantenere organizzate le punte senza perderle.



Porta inserti magnetico	1
Phillips	PH00000 - PH0000 - PH000 - PH00 - PH0 - PH1 - PH2
Taglio	1.0 - 1.3 - 1.5 - 2.0 - 2.5 - 3.0 - 4.0
Esagonali	0.7 - 0.9 - 1.3 - 1.5 - 2.0 - 2.5 - 3.0 - 3.5 - 4.0
Pozi-driv	PZ000 - PZ00 - PZ0 - PZ1
Robertson	0 - 1 - 2
Inserto a "Y"	Y0.6 - Y1.5 - Y2.3 - Y3.0
Inserto a stella	0.8 - 1.2 - 1.5 - 2.0
Inserto a triangolo	2.0 - 2.3 - 3.0
Inserto a U	U2.3 - U2.6
G	G3.8 - G4.5
M	M2.5 - M3.0 - M4.0
MID	
ICS	





0403 € 16,70

SERIE BUSSOLE E INSERTI ESAGONALI

Serie di inserti esagonali composto da 6 bussole, 18 inserti, 1 adattatore per bussole e 1 giravite a cricchetto



Porta inserti a cricchetto	1
Porta inserti magnetico	1
Adattatore	25 mm
Bussole	5 - 6 - 7 - 8 - 9 - 10 mm
Taglio	3 - 4 - 5 - 6 - 7 mm
Phillips	0 - 1 - 2 - 3
Pozi-driv	0 - 1 - 2 - 3
Punta quadrata	S0 - S1 - S2 - S3

0402 € 17,30

SERIE INSERTI ESAGONALI

In acciaio s2 e rivestiti di nichel, composto da 40 inserti e 1 cricchetto reversibile a 72 denti



Attacco	1/4"
Taglio	3 - 4 - 5 - 5,5 - 6 - 7 mm
Phillips	2 x 0 - 2 x 1 - 2 x 2 - 2 x 3
Pozi-driv	2 x 0 - 2 x 1 - 2 x 2 - 2 x 3
Punta quadrata	S0 - S1 - S2 - S3
Torx	T10 - T15 - T20 - T25 - T27 - T30 - T40
Esagonali	2 - 2,5 - 3 - 4 - 5 - 5,5 - 6 mm

0404 € 14,70

SERIE BUSSOLE E INSERTI ESAGONALI

Bussole in CR-V e inserti esagonali in acciaio S2, rivestiti di nichel, con porta inserto a cambio rapido.



Adattatore	25 mm
Porta inserti magnetico	1
Prolunga per bussole	1
Bussole	5 - 6 - 7 - 8 - 9 - 10 - 11 - 12 mm
Taglio	3 - 4 - 5 - 5,5 - 6 - 7 mm
Phillips	0 - 1 - 2 - 3
Pozi-driv	0 - 1 - 2 - 3
Punta quadrata	S0 - S1 - S2 - S3
Torx	T10 - T15 - T20 - T25 - T30 - T40

0104 € 35,30

SERIE INSERTI

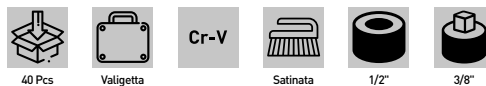

1 Bussola porta inserti 1/2"	1/2" - 1 x 10 mm
1 Bussola porta inserti 3/8"	3/8" - 1 x 10 mm
7 Inserti esagonali 4-5-6-7-8-10-12 mm	30 mm
7 Inserti esagonali 4-5-6-7-8-10-12 mm	75 mm
5 Inserti "XZN" 5-6-8-10-12 mm	30 mm
5 Inserti "XZN" 5-6-8-10-12 mm	75 mm
7 Inserti TORX T20-T25-T30-T40-T45-T50-T55	30 mm
7 Inserti TORX T20-T25-T30-T40-T45-T50-T55	75 mm

0640

€ 21,60

SERIE INSERTI



Inserti	
Phillips	0 - 1 - 2 (x5 Pz/Pcs) - 3
Pozi-driv	0 - 1 - 2 (x5 Pz/Pcs) - 3
Taglio	3 - 4 - 4,5 - 5 - 5,5 - 6 - 6,5 - 7 - 8 mm
Spanner	4 - 6 - 8 - 10
Torx	8 - 10 - 15 - 20 - 25 - 27 - 30 - 40 - 45
Triplay	1 - 2 - 3 - 4
Torx con foro	8 - 10 - 15 - 20 - 25 - 27 - 30 - 35 - 40
Torq-set	6 - 8 - 10
Esagonali metrici	1,5 - 2 - 2,5 - 3 - 4 - 5 - 5,5 - 6 - 8 mm
Robertson	0 - 1 - 2 - 3
Esagonali pollici	1/16 - 5/64 - 3/32 - 7/64 - 1/8 - 9/64 - 5/32 - 3/16 - 7/32 - 1/4
XZN	M5 - M6 - M8
Esagonali con foro	2 - 2,5 - 3 - 4 - 5 - 6 - 5/64 - 3/32 - 7/64 - 1/8 - 9/64 - 5/32
Clutch	1 - 2 - 3

0277

€ 31,70

SERIE BUSSOLE E INSERTI

Con giravite e cricchetto

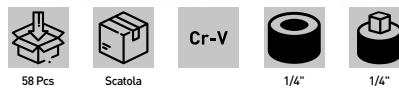

Inserti	25 mm
Phillips (25 mm)	1 - 2 - 3
Pozi-driv	1 - 2 - 3
Taglio	3,5 - 4,5 - 5,5 - 6,5 mm
Spanner	4 - 6 - 8
Torx	10 - 15 - 20 - 25 - 27 - 30 - 40
Tri-wing	1 - 2 - 3 - 4
Torq-set	6 - 8 - 10
Esagonali	2 - 3 - 4 - 5 - 6 - 8 mm
Robertson	1 - 2 - 3
XZN	5 - 6 - 8
Clutch	1 - 2 - 3
Bussole esagonali	5 - 6 - 7 - 8 - 10 mm
Bussole esagonali	3/16 - 1/4 - 9/32 - 5/16 - 3/8
Adattatore	1/4"
Inserto a "Y"	1
Adattatore	1
Porta inserti magnetico	1
Porta inserti	1
Cricchetto reversibile	1/4"



**IS25-ESX****PRO****INSERTI ESAGONALI**

DIN 3126.

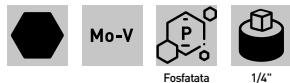

Art.	€	Misura	Lunghezza	Pack
IS25/ES2	€ 0,54	2 mm	25 mm	10
IS25/ES25	€ 0,54	2.5 mm	25 mm	10
IS25/ES3	€ 0,54	3 mm	25 mm	10
IS25/ES4	€ 0,54	4 mm	25 mm	10
IS25/ES5	€ 0,54	5 mm	25 mm	10
IS25/ES6	€ 0,54	6 mm	25 mm	10
IS25/ES8	€ 0,82	8 mm	25 mm	10
IS25/ES10	€ 1,31	10 mm	25 mm	10

IS25-PHX**PRO****INSERTI A CROCE PH**

DIN 3126.

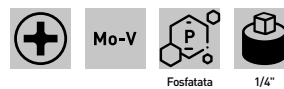

Art.	€	Misura	Lunghezza	Pack
IS25/PH0	€ 0,36	PH0 mm	25 mm	20
IS25/PH1	€ 0,36	PH1 mm	25 mm	20
IS25/PH2	€ 0,36	PH2 mm	25 mm	20
IS25/PH3	€ 0,36	PH3 mm	25 mm	20

IS25-PHXAS**PRO****INSERTI A CROCE PH ANTI SLIP**

DIN 3126.

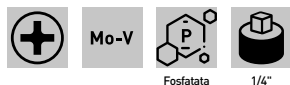

Art.	€	Misura	Lunghezza	Pack
IS25/PH1AS	€ 0,58	PH1 mm	25 mm	10
IS25/PH2AS	€ 0,58	PH2 mm	25 mm	10
IS25/PH3AS	€ 0,58	PH3 mm	25 mm	10

IS25-PZX**PRO****INSERTI A CROCE PZ**

DIN 3126.

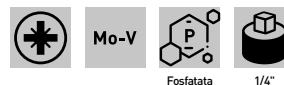

Art.	€	Misura	Lunghezza	Pack
IS25/PZ1	€ 0,36	PZ1 mm	25 mm	20
IS25/PZ2	€ 0,36	PZ2 mm	25 mm	20
IS25/PZ3	€ 0,36	PZ3 mm	25 mm	20

IS25-PZXAS**PRO****INSERTI A CROCE PZ ANTI SLIP**

DIN 3126.

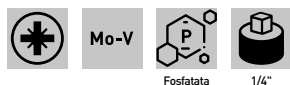

Art.	€	Misura	Lunghezza	Pack
IS25/PZ1AS	€ 0,58	PZ1 mm	25 mm	10
IS25/PZ2AS	€ 0,58	PZ2 mm	25 mm	10
IS25/PZ3AS	€ 0,58	PZ3 mm	25 mm	10

IS25-TGX**PRO****INSERTI A TAGLIO**

DIN 3126.

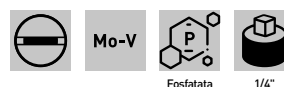

Art.	€	Misura	Lunghezza	Pack
IS25/TG3	€ 0,44	3 x 0.5 mm	25 mm	10
IS25/TG4	€ 0,44	4 x 0.8 mm	25 mm	10
IS25/TG5.5	€ 0,44	5.5 x 0.8 mm	25 mm	10
IS25/TG6	€ 0,44	6 x 1 mm	25 mm	10
IS25/TG8	€ 0,77	8 x 1.2 mm	25 mm	10

IS25-TXX**PRO****INSERTI TORX**

DIN 3126

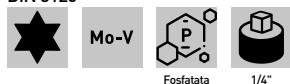

Art.	€	Misura	Lunghezza	Pack
IS25/TX10	€ 0,44	T10 mm	25 mm	10
IS25/TX15	€ 0,44	T15 mm	25 mm	10
IS25/TX20	€ 0,44	T20 mm	25 mm	10
IS25/TX25	€ 0,44	T25 mm	25 mm	10
IS25/TX30	€ 0,44	T30 mm	25 mm	10
IS25/TX35	€ 0,44	T35 mm	25 mm	10
IS25/TX40	€ 0,44	T40 mm	25 mm	10
IS25/TX45	€ 1,15	T45 mm	25 mm	10
IS25/TX50	€ 1,15	T50 mm	25 mm	10
IS25/TX55	€ 1,31	T55 mm	25 mm	10

IS50-ESX**PRO****INSERTI ESAGONALI**

DIN 3126, corpo a diametro ridotto.

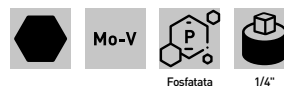

Art.	€	Misura	Lunghezza	Pack
IS50/ES2	€ 1,11	2 mm	50 mm	5
IS50/ES25	€ 0,91	2.5 mm	50 mm	5
IS50/ES3	€ 0,91	3 mm	50 mm	5
IS50/ES4	€ 0,91	4 mm	50 mm	5
IS50/ES5	€ 0,91	5 mm	50 mm	5
IS50/ES6	€ 0,91	6 mm	50 mm	5
IS50/ES8	€ 1,15	8 mm	50 mm	5
IS50/ES10	€ 1,15	10 mm	50 mm	5



IS50-PHX

PRO

INSERTI A CROCE PH

DIN 3126, corpo a diametro ridotto.

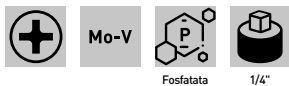

Art.	€	Misura	Lunghezza	Pack
IS50/PH1	€ 0,73	PH 1 mm	50 mm	10
IS50/PH2	€ 0,73	PH 2 mm	50 mm	10
IS50/PH3	€ 0,73	PH 3 mm	50 mm	10

IS50-PZX

PRO

INSERTI A CROCE PZ

DIN 3126, corpo a diametro ridotto.

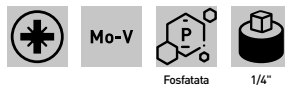

Art.	€	Misura	Lunghezza	Pack
IS50/PZ1	€ 0,73	PZ1 mm	50 mm	10
IS50/PZ2	€ 0,73	PZ2 mm	50 mm	10
IS50/PZ3	€ 0,73	PZ3 mm	50 mm	10

IS50-TGX

PRO

INSERTI A TAGLIO

DIN 3126, corpo a diametro ridotto.

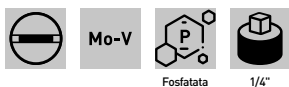

Art.	€	Misura	Lunghezza	Pack
IS50/TG3	€ 1,15	3 x 0.5 mm	50 mm	5
IS50/TG4	€ 1,15	4 x 0.8 mm	50 mm	5
IS50/TG5.5	€ 1,15	5.5 x 0.8 mm	50 mm	5
IS50/TG6	€ 1,15	6 x 1 mm	50 mm	5
IS50/TG8	€ 1,31	8 x 1.2 mm	50 mm	5

IS50-TXX

PRO

INSERTI TORX

DIN 3126, corpo a diametro ridotto.

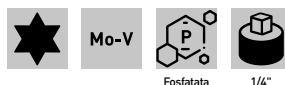

Art.	€	Misura	Lunghezza	Pack
IS50/TX10	€ 1,31	T10 mm	50 mm	5
IS50/TX15	€ 1,31	T15 mm	50 mm	5
IS50/TX20	€ 1,31	T20 mm	50 mm	5
IS50/TX25	€ 1,31	T25 mm	50 mm	5
IS50/TX30	€ 1,31	T30 mm	50 mm	5
IS50/TX35	€ 1,31	T35 mm	50 mm	5
IS50/TX40	€ 1,31	T40 mm	50 mm	5

S018

€ 86,50

SET RIVETTATRICI CON RIVETTI



Rivetti
Rivetti filettati

50 x ø2,4 mm - 50 x ø3,2 mm - 50 x ø4,0 mm - 50 x ø4,8 mm
50 x M3 - 50 x M4 - 25 x M5 - 25 x M6 - 20 x M8



0455

PRO € 95,20

RIVETTATRICE A DOPPIA LEVA PER INSERTI FILETTATI

Completa di 7 tiranti filettati e 7 testine



15 Pcs Valigetta Acciaio Temprato

Tiranti filettati M3 - M4 - M5 - M6 - M8 - M10 - M12
Lunghezza 400 mm

0469

PRO € 52,80

RIVETTATRICE PER INSERTI FILETTATI

Completa di 4 tiranti filettati e 4 testine. Manici ergonomici.



10 Pcs Scatola Acciaio Temprato

Tiranti filettati M3 - M4 - M5 - M6
Lunghezza 200 mm

0453

PRO € 42,70

RIVETTATRICE A DOPPIA LEVA

Leve lunghe per lavorare senza sforzo, anche con rivetti da 6.4mm. Contenitore in plastica, sotto alla rivettatrice, per raccogliere i perni dei rivetti usati da riciclare.



Scatola Acciaio Temprato

Rivetti Ø 3,2 - 4,0 - 4,8 - 6,4 mm
Lunghezza 400 mm

0454

PRO € 48,10

RIVETTATRICE A DOPPIA LEVA A CAMBIO RAPIDO

Per rivetti da 3.2mm a 6.4mm. Leve lunghe per lavorare senza sforzo, anche con rivetti da 6.4mm. Contenitore in plastica, per raccogliere i perni dei rivetti usati da riciclare.



Scatola Acciaio Temprato

Rivetti Ø 3,2 - 4,0 - 4,8 - 6,4 mm
Lunghezza 400 mm

0470

PRO € 17,30

RIVETTATRICE A CAMBIO RAPIDO

Con testina rotante a 4 posizioni



Append. Acciaio Temprato

Rivetti 2,4 mm - 3/32", 3,2 mm - 1/8", 4,0 mm - 5/32", 4,8 mm - 3/16"



0789

€ 17,30

RIVETTATRICE MANUALE

Append. Alluminio

Rivetti Ø 2,4 ÷ 4,8 mm
Lunghezza 255 mm

0058

€ 14,30

SET RIVETTATRICE CON RIVETTI

Append. Acciaio

Rivetti Ø 2,4 ÷ 4,0 mm



0124

€ 11,40

RIVETTATRICE MANUALE

Append. Acciaio

Rivetti Ø 2,4 ÷ 4,0 mm



0872/P **PRO** € 65,30

SERIE PINZE LUNGHE A DOPPIO
SNODO



Lunghezza	335 mm
Lunghezza	300 mm

0872/PDD **PRO** € 24,50

PINZA LUNGA A DOPPIO FULCRO
DRITTA



Lunghezza	335 mm
Spessore	10 mm

0872/PCD **PRO** € 24,50

PINZA LUNGA A DOPPIO FULCRO A 45°



Lunghezza	335 mm
Spessore	10 mm

0872/OPD **PRO** € 25,50

PINZA LUNGA A DOPPIO FULCRO

Ad occhio, con ganasce tonde che permettono una presa non inferiore a 8mm



Lunghezza	335 mm
Spessore	10 mm

0873-U **PRO**

PINZE UNIVERSALI

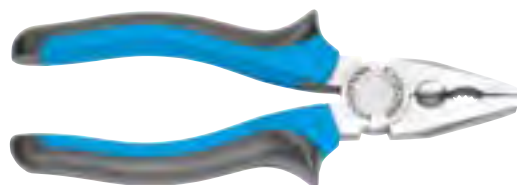
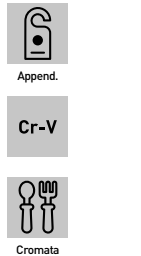

Art.	€	Lunghezza	Spessore
0873/U6	€ 8,00	160 mm	11 mm
0873/U7	€ 8,50	180 mm	10,5 mm
0873/U8	€ 9,60	200 mm	12 mm

0873-BD **PRO**

PINZA A BECCHI MEZZITONDI

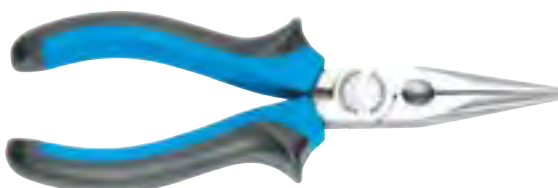
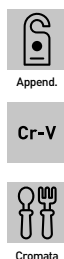

Art.	€	Lunghezza	Spessore
0873/BD6	€ 6,90	160 mm	9 mm
0873/BD8	€ 8,70	200 mm	10 mm

0873-BC **PRO**

PINZA A BECCHI MEZZITONDI PIEGATI 45°



Art.	€	Lunghezza	Spessore
0873/BC6	€ 6,90	160 mm	9 mm
0873/BC8	€ 8,70	200 mm	10 mm

0873/TL **PRO** € 7,50

TRONCHESE A TAGLIENTE
LATERALE



Lunghezza	160 mm
Spessore	9 mm



0873/TF

PRO € 9,50

TRONCHESE A TAGLIENTE FRONTALE



Blister



Cr-V



Cromata

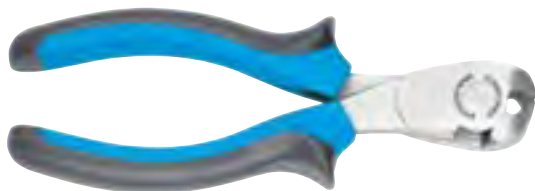

Lunghezza 160 mm
Spessore 11 mm

0020/1

€ 5,10

PINZA PER ELETTRONICA A BECCHI EXTRA LUNGH



Blister



Acciaio



Cromata



Lunghezza 150 mm

0020/2

€ 3,84

PINZA PER ELETTRONICA A BECCHI CURVI



Blister



Acciaio



Cromata



Lunghezza 125 mm

0020/3

€ 4,18

PINZA PER ELETTRONICA A BECCHI PIATTI



Blister



Acciaio



Cromata



Lunghezza 125 mm

0020/4

€ 4,09

PINZA PER ELETTRONICA A BECCHI LUNGH



Blister



Acciaio



Cromata



Lunghezza 125 mm

0020/5

€ 4,61

TRONCHESINA PER ELETTRONICA A TAGLIO FRONTALE



Blister



Acciaio



Cromata



Lunghezza 110 mm

0020/6

€ 4,45

TRONCHESINA PER ELETTRONICA A TAGLIO LATERALE



Blister



Acciaio



Cromata



Lunghezza 110 mm

0020

€ 15,80

SERIE PINZE PER ELETTRONICA



5 Pcs



Blister



Acciaio



Cromata

Lunghezza 110 ÷ 125 mm



08X

PINZE UNIVERSALI



Art.	€	Lunghezza	Spessore
0810	€ 5,50	160 mm	11 mm
0811	€ 6,80	180 mm	11 mm
0850	€ 7,50	200 mm	13 mm

08XX

PINZE A BECCHI MEZZITONDI



Art.	€	Lunghezza	Spessore
0812	€ 5,60	160 mm	10 mm
0851	€ 7,10	200 mm	11 mm

0813

€ 6,10

**PINZE A BECCHI MEZZITONDI
PIEGATI 45°**



Lunghezza	160 mm
Spessore	10 mm

0814

€ 5,10

**TRONCHESE A TAGLIENTE
LATERALE**



Lunghezza	160 mm
Spessore	10 mm

0841

PRO € 21,70

PINZE A CRICCHETTO

Con leva di sbloccaggio



Per capicorda preisolati	Ø 0,8 ÷ 3,5 mm / 0,25 ÷ 6 mm2 AWG 22-10
Lunghezza	230 mm
Spessore	12 mm

0843

PRO € 22,60

PINZE A CRICCHETTO

Con leva di sbloccaggio



Per capicorda non isolati	Ø 1 ÷ 3,5 mm / 0,5 ÷ 6 mm2 AWG 20-10
Lunghezza	230 mm
Spessore	12 mm

0847

PRO € 70,80

**PINZA PER TERMINALI DRITTI
PREISOLATI**

Con leva di sbloccaggio



Terminali	0,25 ÷ 6 mm2 AWG 23-10
Lunghezza	175 mm
Spessore	12 mm

0628

PRO € 17,10

PINZA PER CONNETTORI

Con manopola di sbloccaggio



Connettori	RJ-11 (6P4C); RJ-12 (6P6C); RJ-45 (8P8C)
------------	--



0826 € 27,70

PINZA FASTONATRICE E SPELLAFILO

Pinza fastonatrice per faston piccoli non isolati e spellafilo per fili sottili, settore auto e computer



Lunghezza	215 mm
Terminali	AWG 30-26 - AWG 24-20 - AWG 18-14
Capacità di taglio	∅ 0,25 - 0,3 - 0,4 - 0,5 - 0,65 - 0,8 - 1,0 mm AWG30 - AWG28 - AWG26 - AWG24 - AWG22 - AWG20 - AWG18

0122 € 9,30

PINZA FASTONATRICE UNIVERSALE IN KIT

Con terminali isolati



Lunghezza	220 mm
-----------	--------

024XE **NEW**

PINZE PER ANELLI ELASTICI DI SICUREZZA

Dritta per esterni



Art.	€	Anelli elastici	Lunghezza
0246	€ 10,80	∅ 19 ÷ 60 mm	175 mm
0636	€ 9,10	∅ 10 ÷ 25 mm	150 mm
0674	€ 8,20	∅ 3 ÷ 10 mm	125 mm
0676	€ 10,40	∅ 32 ÷ 80 mm	225 mm

024XI **NEW**

PINZE PER ANELLI ELASTICI DI SICUREZZA

Dritta per interni



Art.	€	Anelli elastici	Lunghezza
0248	€ 10,80	∅ 19 ÷ 60 mm	175 mm
0638	€ 9,10	∅ 8 ÷ 25 mm	150 mm
0619	€ 8,20	∅ 3 ÷ 10 mm	125 mm
0631	€ 10,40	∅ 32 ÷ 80 mm	225 mm

063XE **NEW**

PINZE PER ANELLI ELASTICI DI SICUREZZA

Curva per esterni



Art.	€	Anelli elastici	Lunghezza
0247	€ 10,80	∅ 19 ÷ 60 mm	175 mm
0637	€ 9,10	∅ 10 ÷ 25 mm	150 mm
0108	€ 8,20	∅ 3 ÷ 10 mm	125 mm
0324	€ 10,40	∅ 32 ÷ 80 mm	225 mm

063XI **NEW**

PINZE PER ANELLI ELASTICI DI SICUREZZA

Curva per interni



Art.	€	Anelli elastici	Lunghezza
0249	€ 10,80	∅ 19 ÷ 60 mm	175 mm
0639	€ 9,10	∅ 8 ÷ 25 mm	150 mm
0340	€ 8,20	∅ 3 ÷ 10 mm	125 mm
0364	€ 10,40	∅ 32 ÷ 80 mm	225 mm

0136 € 22,80

SERIE PINZE IN NYLON

Per stringere tubi per liquidi auto

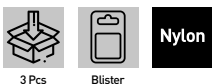

Lunghezza	158 - 185 - 254 mm
Diametro tubo	10 - 15 - 24 mm

0603 **PRO** € 97,00

SERIE PINZE PER FASCETTE AUTO





0118 € 4,75

PINZA IDRAULICO

6 posizioni



Lunghezza 240 mm

0834- **NEW**

TENAGLIA CEMENTISTA

DIN ISO 9242.



Art.	€	Lunghezza
0834	€ 5,50	220 mm
0834/200	€ 4,66	200 mm
0834/250	€ 5,80	250 mm
0834/280	€ 7,30	280 mm

0121 € 23,70

PINZA GRIP A MORSETTO



Lunghezza 230 mm
Regolabile 0 ÷ 155 mm

0119 € 6,80

PINZA GRIP



Lunghezza 220 mm

0831- **PRO**

PINZA IDRAULICO

DIN ISO 8976/C, 7 posizioni.



Art.	€	Lunghezza
0831/175	€ 7,70	175 mm
0831/250	€ 9,10	250 mm
0831/300	€ 11,20	300 mm

0206 € 6,50

TENAGLIA DA FALEGNAME

Tenaglia da falegname



Lunghezza 200 mm

0120 € 9,30

PINZA REGOLABILE A GINOCCHIERA 4 POSIZIONI



Lunghezza 230 mm
Apertura 18 - 39 - 43 mm

0379 € 11,60

PINZA GRIP CON GANASCE A FORCELLA



Lunghezza 225 mm



0368-

PINZA A MORSETTO AUTOMATICA



Scatola

Cr-V



Satinata

Art.	€	Lunghezza
0368/7	€ 26,20	160 mm
0368/10	€ 33,50	230 mm

0370-

PINZA A MORSETTO AUTOMATICA CON BECCHI LUNGI



Scatola

Cr-V



Satinata

Art.	€	Lunghezza
0370/8	€ 28,50	200 mm
0370/11	€ 40,70	275 mm

0373-

PINZA A MORSETTO AUTOMATICA CON BECCHI A "C"



Scatola

Cr-V



Satinata

Art.	€	Lunghezza	Apertura
0373/9	€ 32,70	210 mm	65 mm
0373/11	€ 39,50	300 mm	95 mm

0130-

GIRATUBO



Cr-V

Art.	€	Dimensioni	Apertura max
0130/350	€ 15,10	350 mm - 14"	50 mm
0130/600	€ 23,30	600 mm - 24"	90 mm

0225-

GIRATUBO A 45°



Cr-V

Art.	€	Dimensioni	Apertura max
0225/340	€ 19,10	340 mm - 1"	46 mm
0225/440	€ 28,70	440 mm - 1,5"	62 mm
0225/580	€ 35,60	580 mm - 2"	72 mm
0225/700	€ 48,40	700 mm - 3"	100 mm

0227-

GIRATUBO A 90°



Cr-V

Art.	€	Dimensioni	Apertura max
0227/340	€ 19,10	340 mm - 1" mm	41 mm
0227/440	€ 27,30	415 mm - 1,5" mm	55 mm
0227/580	€ 39,50	580 mm - 2" mm	75 mm
0227/700	€ 53,80	700 mm - 3" mm	100 mm

0511 € 36,10

MAZZA

Con manico di sicurezza in fibra di vetro e plastica, rivestito in gomma antiscivolo



Fibra di vetro

Lunghezza	820 mm
Peso della testa	3,50 kg
Peso netto	4,45 kg

0781 € 12,20

MAZZETTA PER MURATORE

DIN 6475, con manico di sicurezza in fibra di vetro e plastica, rivestito in gomma antiscivolo.



Fibra di vetro

Lunghezza	260 mm
Peso netto	1000 g

0780 € 9,60

MARTELLLO CARPENTIERE

Con manico di sicurezza in fibra di vetro e plastica, rivestito in gomma antiscivolo



Fibra di vetro

Peso netto	500 g
------------	-------

0514-

MARTELLLO TIPO TEDESCO

DIN 1041, con manico di sicurezza in fibra di vetro e plastica, rivestito in gomma antiscivolo.



Fibra di vetro

Art.	€	Peso netto
0514/200	€ 5,10	200 g
0514/300	€ 6,30	300 g
0514/400	€ 7,50	400 g
0514/500	€ 9,00	500 g
0514/1000	€ 13,40	1000 g

0154-

MARTELLLO TIPO TEDESCO

DIN 1041.



Legno

Art.	€	Peso netto
0154/100DIN	€ 2,70	100 g
0154/200DIN	€ 3,83	200 g
0154/300DIN	€ 4,02	300 g
0154/400DIN	€ 5,30	400 g
0154/500DIN	€ 5,60	500 g
0154/600DIN	€ 6,20	600 g
0154/800DIN	€ 6,90	800 g
0154/1000DIN	€ 10,20	1000 g
0154/1500DIN	€ 11,30	1500 g
0154/2000DIN	€ 14,40	2000 g

0153-

MAZZETTA PER MURATORE

DIN 6475.



Legno

Art.	€	Peso netto
0153/800DIN	€ 6,90	800 g
0153/1000DIN	€ 7,60	1000 g
0153/1250DIN	€ 9,30	1250 g
0153/1500DIN	€ 10,80	1500 g



0169-

MARTELO CARPENTIERE

Con porta chiodo magnetico



Legno

Art.	€	Peso netto
0169/300	€ 6,90	300 g
0169/400	€ 8,30	400 g

0216/400

€ 8,00

MARTELLINA MALEPEGGIO

Con manico in legno



Legno

Lunghezza manico	380 mm
Peso netto	400 g

0239/400

€ 9,90

MARTELLINA MALEPEGGIO

Con manico in fibra di vetro e plastica rivestita in gomma antiscivolo



Fibra di vetro

Lunghezza manico	380 mm
Peso netto	400 g

0148/500

€ 4,12

MAZZUOLO GOMMA



Legno

Testa	ø 65 mm
Peso netto	500 g

0243-

MAZZUOLO GOMMA E FIBRA



Fibra di vetro

Art.	€	Testa	Peso netto
0243/30	€ 5,40	ø 30 mm	350 g
0243/40	€ 7,60	ø 40 mm	500 g

0794-

MAZZUOLO GOMMA

E manico in fibra di vetro



Fibra di vetro

Art.	€	Testa	Peso netto
0794/350	€ 5,50	ø 55 mm	350 g
0794/450	€ 7,70	ø 58 mm	500 g

0808-

MAZZUOLO

In alluminio con manico anatomico e teste in polietilene



Legno

Art.	€	Testa	Peso netto
0808/35	€ 18,20	ø 35 mm	350 g
0808/60	€ 43,20	ø 60 mm	800 g

033X

MAZZUOLO ANTIRIMBALZO



Art.	€	Testa	Peso netto
0336	€ 11,90	ø 45 mm	500 g
0337	€ 13,40	ø 50 mm	900 g

0839-

PRO

MAZZUOLO ANTIRIMBALZO

In nylon, teste di ricambio



Art.	€	Testa	Peso netto
0839/40	€ 50,10	ø 40 mm	750 g
0839/50	€ 58,30	ø 50 mm	1000 g
0839/60	€ 65,30	ø 60 mm	1500 g

0839-XT

TESTA DI RICAMBIO

Per mazzuolo antirimbalo 0839-



Art.	€	Testa
0839/40T	€ 11,80	ø 40 mm
0839/50T	€ 11,80	ø 50 mm
0839/60T	€ 17,20	ø 60 mm

072X

PRO

MAZZUOLO ANTIRIMBALZO

Con teste in nylon, corpo monoblocco in lega antiurto. Manico anatomico in rubinia antiscivolo. Massa interna composta da sfere di piombo. Percussori sostituibili in nylon indeformabile.



Art.	€	Testa	Peso netto
0726	€ 70,40	ø 40 mm	550 g
0727	€ 82,40	ø 50 mm	900 g
0728	€ 89,80	ø 60 mm	1100 g

073X

TESTA DI RICAMBIO

Per mazzuolo antirimbalo 072x.



Art.	€	Testa	Pack
0729	€ 20,90	ø 40 mm	2
0730	€ 24,90	ø 50 mm	2
0731	€ 32,30	ø 60 mm	2

G009

€ 15,80

CAVO A SPIRALE DI SICUREZZA PER UTENSILI

Con ganci, per mettere in sicurezza utensili quando si lavora su scale o ponteggi



INOX

Blister

Capacità	5 kg
Lunghezza	430 ÷ 1600 mm





B006-

BULINO

DIN 7250, con stelo ottagonale.



Cr-Mo
Append.

Art.	€	Misure	Lunghezza
B006/4	€ 3,95	4 mm	120 mm
B006/5	€ 5,40	5 mm	150 mm

S022-

SCALPELLO PER METALLO



Cr-Mo
Append.

Art.	€	Dimensioni	Lunghezza
S022/18	€ 8,00	18 mm	150 mm
S022/21	€ 10,90	21 mm	200 mm
S022/25	€ 14,80	25 mm	250 mm
S022/26	€ 14,40	26 mm	240 mm

C015

SERIE DI CACCIASPINE

Con stelo ottagonale e paramano

PRO € 60,20

Cr-Mo
7 Pcs Append. Cromata

Misure \varnothing 2 - 3 - 4 - 5 - 6 - 7 - 8 mm



0127

SERIE SCALPELLI, PUNZONI E BULINO CON SUPPORTO IN PLASTICA

€ 14,50

Cr-V
6 Pcs Blister

Lunghezza 120 - 150 mm



C012-

CACCIASPINE

Con stelo ottagonale



Cr-Mo
Append.

Art.	€	Dimensioni	Lunghezza
C012/02	€ 4,55	\varnothing 2 mm	150 mm
C012/03	€ 4,55	\varnothing 3 mm	150 mm
C012/04	€ 4,55	\varnothing 4 mm	150 mm
C012/05	€ 5,10	\varnothing 5 mm	150 mm
C012/06	€ 5,60	\varnothing 6 mm	150 mm
C012/08	€ 6,20	\varnothing 8 mm	150 mm

C015-

CACCIASPINE

Con stelo ottagonale e paramano

PRO



Cr-Mo
Append. Cromata

Art.	€	Misura	Lunghezza
C015/2	€ 7,10	\varnothing 2 x 8 mm	140 mm
C015/3	€ 7,50	\varnothing 3 x 8 mm	150 mm
C015/4	€ 8,10	\varnothing 4 x 10 mm	180 mm
C015/5	€ 8,40	\varnothing 5 x 10 mm	220 mm
C015/6	€ 9,90	\varnothing 6 x 12 mm	210 mm
C015/7	€ 9,90	\varnothing 7 x 12 mm	210 mm
C015/8	€ 10,20	\varnothing 8 x 12 mm	220 mm

0126

SERIE CACCIASPINE CON SUPPORTO IN PLASTICA

€ 13,90

Cr-V
6 Pcs Blister

Dimensioni \varnothing 3-4-5-6-8-10 mm
Lunghezza 150 mm



0391

SERIE SCALPELLI, PUNZONI E BULINO CON PARAMANO

€ 30,90

Cr-V
6 Pcs Append.

Scalpellini	10 x 135 mm, 13 x 150 mm, 16 x 160 mm
Bulini	04 x 130 mm
Cacciaspine conico	03 x 120 mm
Cacciaspine cilindrico	03 x 120 mm



0381

€ 8,30

SEGNACENTRO AUTOMATICO

A molla



Lunghezza 125 mm

0396

€ 12,60

SERIE SCALPELLI DA FERRO



Dimensioni 10 x 8 x 140 mm, 13 x 9,5 x 150 mm, 16 x 12 x 170 mm

0152

€ 5,50

SERIE SCALPELLI CON PARAMANO



Dimensioni 16 x 250 mm

0258

€ 4,12

SCALPELLO A TAGLIO CON PARAMANO



Dimensioni 16 x 300 mm

0259

€ 3,95

SCALPELLO A PUNTA CON PARAMANO



Dimensioni 16 x 300 mm





0300

€ 17,80

SERIE SCALPELLI DA LEGNO



4 Pcs



Blister



Acciaio

Durezza HRC 58-60
Dimensioni 10-16-20-25 mm

0168

€ 10,50

SERIE SCALPELLI DA LEGNO



5 Pcs



Blister



Acciaio

Durezza HRC 58-60
Misure 240 x 6-10-16-20-24 mm

0162

€ 17,60

SERIE SGORBIE DA LEGNO PER TORNIO



3 Pcs



Blister



Acciaio

Durezza HRC 58-60
Lunghezza totale 370 mm

0301-

SCALPELLO PER FALEGNAME

Durezza HRC 58-60.



Blister



Acciaio

Art.	€	Dimensioni
0301/06	€ 4,27	6 mm
0301/10	€ 4,27	10 mm
0301/16	€ 5,10	16 mm
0301/20	€ 5,10	18.5 mm
0301/24	€ 6,20	25 mm

0306

€ 59,80

SERIE SGORBIE PER INTAGLIATORE



12 Pcs



Scatola



Acciaio



Cromata

Durezza HRC 58-60
Lunghezza 215 mm

0166

€ 18,80

PIALLA FALEGNAME CON DOPPIA LAMA



Scatola



Acciaio

Lunghezza pialla 225 mm
Larghezza lama 50 mm

0519 € 5,40

SERIE RASPE PER LEGNO CON MANICO IN PLASTICA



Dimensioni 200 mm - 8" mm



0160 € 16,60

SERIE LIME DA FERRO CON MANICO ANATOMICO



Dimensioni 200 mm - 8" mm



0219 € 5,30

SERIE LIME



Lunghezza totale 180 mm



0214 € 5,40

SERIE LIME AGO



Dimensioni Ø 3 x 140 mm



L011 € 25,50

SERIE LIME DIAMANTATE CURVE



Lunghezza 140 mm



L012 € 33,20

SERIE LIME DIAMANTATE



Lunghezza 180 mm



L013 € 21,70

SERIE LIME DIAMANTATE



Lunghezza 140 mm



L012/PIA € 9,10

LIMA PIATTA DIAMANTATA



Lunghezza 180 mm





0737-

LIME PER MECCANICA

Forma rettangolare. complete di impugnatura, anatomica antisdrucciolo



Art.	€	Taglio	Dimensioni	Pack
0737/150T2	€ 4,63	Mezzo dolce	150 mm 6 Inch	10
0737/150T3	€ 4,63	Dolce	150 mm 6 Inch	10
0737/200T2	€ 5,50	Mezzo dolce	200 mm 8 Inch	10
0737/200T3	€ 5,50	Dolce	200 mm 8 Inch	10
0737/250T2	€ 6,80	Mezzo dolce	250 mm 10 Inch	10
0737/250T3	€ 6,80	Dolce	250 mm 10 Inch	10

0738-

LIME PER MECCANICA

Forma triangolare. complete di impugnatura, anatomica antisdrucciolo



Art.	€	Taglio	Dimensioni	Pack
0738/150T2	€ 4,63	Mezzo dolce	150 mm 6 Inch	10
0738/150T3	€ 4,63	Dolce	150 mm 6 Inch	10
0738/200T2	€ 5,50	Mezzo dolce	200 mm 8 Inch	10
0738/200T3	€ 5,50	Dolce	200 mm 8 Inch	10
0738/250T2	€ 6,80	Mezzo dolce	250 mm 10 Inch	10
0738/250T3	€ 6,80	Dolce	250 mm 10 Inch	10

0739-

LIME PER MECCANICA

Forma mezza tonda. complete di impugnatura, anatomica antisdrucciolo



Art.	€	Taglio	Dimensioni	Pack
0739/150T2	€ 4,63	Mezzo dolce	150 mm 6 Inch	10
0739/150T3	€ 4,63	Dolce	150 mm 6 Inch	10
0739/200T2	€ 5,50	Mezzo dolce	200 mm 8 Inch	10
0739/200T3	€ 5,50	Dolce	200 mm 8 Inch	10
0739/250T2	€ 6,80	Mezzo dolce	250 mm 10 Inch	10
0739/250T3	€ 6,80	Dolce	250 mm 10 Inch	10

0740-

LIME PER MECCANICA

Forma tonda. complete di impugnatura, anatomica antisdrucciolo



Art.	€	Taglio	Dimensioni	Pack
0740/150T2	€ 4,63	Mezzo dolce	150 mm 6 Inch	10
0740/150T3	€ 4,63	Dolce	150 mm 6 Inch	10
0740/200T2	€ 5,50	Mezzo dolce	200 mm 8 Inch	10
0740/200T3	€ 5,50	Dolce	200 mm 8 Inch	10
0740/250T2	€ 6,80	Mezzo dolce	250 mm 10 Inch	10
0740/250T3	€ 6,80	Dolce	250 mm 10 Inch	10

0741-

LIME PER MECCANICA

Forma quadrata. complete di impugnatura, anatomica antisdrucciolo



Art.	€	Taglio	Dimensioni	Pack
0741/150T2	€ 4,63	Mezzo dolce	150 mm 6 Inch	10
0741/150T3	€ 4,63	Dolce	150 mm 6 Inch	10
0741/200T2	€ 5,50	Mezzo dolce	200 mm 8 Inch	10
0741/200T3	€ 5,50	Dolce	200 mm 8 Inch	10
0741/250T2	€ 6,80	Mezzo dolce	250 mm 10 Inch	10
0741/250T3	€ 6,80	Dolce	250 mm 10 Inch	10

0742-

IMPUGNATURA ANATOMICA ANTISDRUCCIOLIO



Art.	€	Per lima	Pack
0742/4	€ 1,33	4" - 6"	12
0742/6	€ 1,33	6" - 10"	12
0742/10	€ 1,52	10" - 16"	12

0202 € 34,80

SERIE LEVE A BATTERE



Dimensioni 230mm/9" - 300mm/12" - 450mm/18" - 590mm/24"

0192 € 140,00

SERIE LEVE A BATTERE

1 Pz dritta 910mm/36", 1 Pz curva 45° 910mm/36", 1 Pz curva 60° 610mm/24", 1 Pz curva 90° 610mm/24".



L007 € 7,10

LEVA GOMMISTA PER MOTO



Dimensioni 215 x 16 X 5 mm

0320 € 6,30

LEVICINO CARPENTIERE IN ACCIAIO FORGIATO



Lunghezza totale 600 mm
Esagono 15,6 mm

0198 € 5,80

LEVA CON ESTREMITÀ A PUNTA

Leva con estremità a punta



Lunghezza 400 mm
A 30 mm
B 23 mm
Pack 5

0267 € 9,10

LEVA GOMMISTA



Dimensioni 510 x 26 x 9 mm





0623 **PRO** € 5,10

CUTTER CON GUIDALAMA IN ACCIAIO, LAME DI RICAMBIO INCLUSE

Con caricamento automatico della lama



Lame in dotazione 3
Larghezza lama 18 mm

0627 **PRO** € 3,95

CUTTER CON GUIDALAMA IN ACCIAIO, LAME DI RICAMBIO INCLUSE

Con caricamento automatico della lama



Lame in dotazione 5
Larghezza lama 9 mm

0617 € 2,49

CUTTER CON GUIDALAMA IN ACCIAIO, LAME DI RICAMBIO INCLUSE



Lame in dotazione 3
Larghezza lama 18 mm

0613 € 1,98

CUTTER CON GUIDALAMA IN ACCIAIO ISO 9001.



Lame in dotazione 3
Larghezza lama 9 mm

0096 € 2,49

CUTTER CON GUIDALAMA IN ACCIAIO, LAME DI RICAMBIO INCLUSE



Lame in dotazione 3
Larghezza lama 18 mm

0612 € 2,97

CUTTER CON GUIDALAMA IN ACCIAIO



Lame in dotazione 3
Larghezza lama 9 mm

0611 € 2,77
CUTTER CON GUIDALAMA IN ACCIAIO



Lame in dotazione 3
 Larghezza lama 9 mm

0035 **PRO** € 6,20
CUTTER DI SICUREZZA, LAME DI RICAMBIO INCLUSE



Lame in dotazione 4
 Lama trapezoidale 19 x 61 x 0,6 mm

0792 € 10,20
CUTTER AUTOMATICO CON GUIDALAMA IN ACCIAIO, LAME DI RICAMBIO INCLUSE



Lame in dotazione 5
 Larghezza lama 25 x 0,7 mm

0696 € 7,60
CUTTER A SERRAMANICO, LAME DI RICAMBIO INCLUSE



Lame in dotazione 5
 Larghezza lama 20 mm

0095 € 1,64
SERIE CUTTER

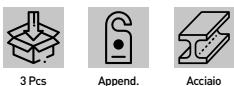

0696/L € 1,88
SERIE LAME PER CUTTER

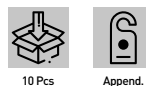

Lama trapezoidale 19 x 61 x 0,6 mm



0627/L € 2,05
SET 10 LAME PER CUTTER

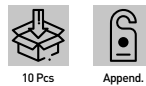

Lunghezza lama 9 mm





0096/L € 2,05

SERIE LAME PER CUTTER



0792/L € 7,80

SERIE LAME PER CUTTER



0420 € 6,90

SBAVATORE CON 1 LAMA



Lunghezza	120 mm
Diametro massimo manico	9,2 mm
Lama	E100 - Ø 3,2 mm
Materiale lama	HSS

0411 **PRO** € 13,40

SBAVATORE CON 1 LAMA



Lunghezza	124 mm
Diametro massimo manico	29 mm
Lama	E100 - Ø 3,2 mm
Materiale lama	HSS

0415 € 9,10

SBAVATORE CON 2 LAME

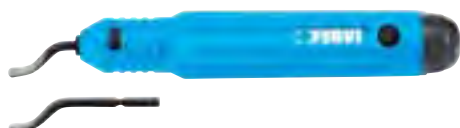

Lunghezza	125 mm
Diametro massimo manico	22 mm
Lama	E100 - E200 - Ø 3,2 mm
Materiale lama	HSS

S002 € 14,50

SBAVATORE ESTENSIBILE CON 3 LAME

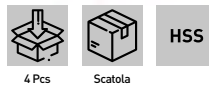

Lama	Ø 3,2 mm
Dimensioni lama	E100 - E200 - E300

0420/S **NEW** € 21,20

SERIE SBAVATORI CON LAMA

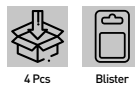

Lunghezza	120 mm
Lama	Ø 3.2mm

S002/E100 € 14,40

SERIE LAME IN HSS CON GAMBO LUNGO

Per sbavatura interna ed esterna di materiali a truciolo lungo come acciaio, alluminio, materie plastiche



S002/E200 € 13,40

SERIE LAME IN HSS BIDIREZIONALI

Con gambo lungo per sbavatura interna ed esterna di materiali a truciolo corto come ottone e ghisa



S002/E300 € 14,40

SERIE LAME IN HSS BIDIREZIONALI

Con gambo lungo per sbavatura interna ed esterna di fori fino a 4mm di spessore.



S005 € 13,50

SBAVATORE DOPPIO CON DISCHI IN HSS

Per sbavare lamiere d'acciaio, alluminio, ottone, rame e plastica max 10mm.



HSS
Scatola

S005/R € 15,10

SERIE ROTELLINE



HSS
4 Pcs Scatola

0384 € 6,20

SBAVATORE INTERNO ED ESTERNO PER TUBI

Per rame e metalli ferrosi



Plastic
2 Pcs Scatola

Capacità 3 ÷ 32 mm 3/16" ÷ 1-1/2"

0647/25 € 16,60

RASCHIETTO CON LAMA IN METALLO DURO DA 25MM A TRE TAGLIANTI



HM
Blister Satinata

0647/50 € 17,30

RASCHIETTO CON LAMA IN METALLO DURO DA 50MM A DUE TAGLIANTI



HM
Blister Satinata

0647/25L € 13,50

SERIE 2 PZ LAME RICAMBIO



HM
2 Pcs Blister

0647/50L € 13,80

SERIE 2 PZ LAME RICAMBIO



HM
2 Pcs Blister

0647/65 € 18,90

RASCHIETTO CON LAMA IN METALLO DURO DA 65MM A DUE TAGLIANTI



HM
Blister Satinata

0647/65L € 13,80

SERIE 2 PZ LAME RICAMBIO



HM
2 Pcs Blister

**0367**

€ 25,50

SERIE COLTELLI TAGLIABALSA

Con pietra a grana 240, 26 coltelli di ricambio.
Da usare su legno, polistirolo, EVA, gomma piuma.



34 Pcs



Blister



Acciaio



Pietra per affilare	1 - grana / grain 240
Giravite di precisione	1
Pinzetta	1
Manici a 2 colori	4
Coltelli di ricambio	26
Cofanetto	1, ABS+TPR

0226

€ 9,00

**ARCHETTO CON LAMA,
IMPUGNATURA IN ALLUMINIO**

Con impugnatura supplementare per piccoli tagli. corpo in alluminio e lama bimetallica



Lunghezza lama 310 mm

0161

€ 3,79

MINI ARCHETTO CON LAMA

Alu

Alluminio

Lunghezza lama 150 mm

0724/B**PRO** € 1,90**LAMA BIMETALLICA**

ISO 2336-1.



Scatola

Misure 300 x 12,7 x 0,62 mm x 24T - 12" x 1/2" x 0.025" x 24T
Pack 10**0869**

€ 14,40

**SEGACCIO DA FALEGNAME CON
TRIPLA AFFILATURA A DIAMANTE**

Acciaio

Lunghezza lama 400 mm

0629

€ 19,80

ARCHETTO CON LAMA

Corpo in alluminio e lama bimetallica



Lunghezza lama 300 mm

0327

€ 7,50

SEGACCIO AD ARCO PER LEGNO

Acciaio



Lunghezza lama 530 mm / 21"

0159

€ 0,28

LAMA IN ACCIAIO AL CARBONIO

ISO 2336-1.



Scatola

Misure 300 x 12,7 x 0,62 mm x 24T - 12" x 1/2" x 0.025" x 24T
Pack 100

0670

€ 51,20

RODITRICE PER TRAPANO

A doppia testa con accessorio per tagli dritti e circolari



Scatola

HSS

TiN

0670/U € 13,50
SERIE UTENSILI DI RICAMBIO



Capacità di taglio

lamiere ferrose	1,8 mm
lamiere acciaio inox	1,2 mm
lamiere di rame e alluminio	2,0 mm
materiali plastici	2,0 mm
Velocità di rotazione	1500 - 3000 rpm
Collare	Ø 43,2 mm
Cassetina di metallo	

0655/L

€ 9,40

CESOIA SINISTRA PER LAMIERA

Con lame microdentate indurite e manici anatomici



0655/S

€ 9,40

CESOIA DRITTA PER LAMIERA

Con lame microdentate indurite e manici anatomici



0655/R

€ 9,40

CESOIA DESTRA PER LAMIERA

Con lame microdentate indurite e manici anatomici



Blister

Cr-V



Cromata

Lunghezza	245 mm
Durezza	50 - 52 HRC



Blister

Cr-V



Cromata

Lunghezza	245 mm
Durezza	50 - 52 HRC



Blister

Cr-V



Cromata

Lunghezza	245 mm
Durezza	50 - 52 HRC

0818/250

€ 10,50

FORBICE LAMIERA TIPO AMERICANO



0699/240

€ 6,20

FORBICE INOX

Con manico in nylon



0672

€ 7,50

FORBICE PER ELETTRICISTA

Con lama a rasoio microdentata, manico ergonomico in abs



Blister



Acciaio



Satinata

Lunghezza	250 mm
-----------	--------



Blister

INOX



Satinata

Lunghezza	240 mm
-----------	--------



Blister

INOX



Satinata

Lunghezza	140 mm
-----------	--------

**0672/B****PRO** € 10,20**FORBICE PER ELETTRICISTA**

Con lama a rasoio microdentata, manico ergonomico bicolore antiscivolo



Blister

INOX

Satinata

Lunghezza

140 mm

0141

€ 11,10

FORBICE PER ELETTRICISTA

Blister

INOX

Satinata

Lunghezza

5" 1/2 - 140 mm

F018**PRO** € 25,80**FORBICE PER ELETTRICISTA CON MANICI ISOLATI**

1000V IEC 60900, con lama a rasoio microdentata, manico ergonomico in ABS.



Blister

INOX

Satinata

Lunghezza

6" - 160 mm

0673

€ 10,20

FORBICE MULTIUSO

Con lama a rasoio microdentata, manico ergonomico antiscivolo bicolore in plastica e gomma



Blister

INOX

Satinata

Lunghezza

175 mm / 7" mm

0325

€ 13,20

FORBICE MULTIUSO

Con lama a rasoio microdentata, manico ergonomico antiscivolo bicolore



Blister

INOX

Satinata

Lunghezza

210 mm / 8" mm

0424

€ 12,20

FUSTELLATRICE RINFORZATA

Permette di eseguire piccoli fori su materiali di piccolo spessore come: carta, cartone, gomma e cuoio



Blister



Acciaio

Lunghezza

250 mm

0081

€ 31,30

SERIE FUSTELLE

9 Pcs



Valigetta



Acciaio



Satinata

Misure

ø 5 - 6 - 8 - 10 - 12,5 - 16 - 20 - 25 - 32 mm

0093/22**PRO** € 5,60**TAGLIATUBO PER RAME/PLASTICA**

Con corpo in lega di zinco.



Blister



Acciaio



Temprato

Capacità di taglio

3÷22 mm, 1 / 8" ÷ 55 / 64"

0093/42 **PRO** € 22,20

TAGLIATUBO PER RAME/FERRO

Con corpo in lega di alluminio.



Capacità di taglio 6÷42 mm , 15 / 64" ÷ 1-21 / 32"
Durezza HRC 58-60

0472 € 17,80

BORDATUBO PER RAME E ALLUMINIO



Tubo tondo 5 - 6 - 8 - 10 - 12 - 14 - 16 mm

0844 € 10,20

TAGLIATUBO PER POLIURETANO E GOMMA



Taglio massimo Ø 25 mm

0253 € 9,60

TAGLIATUBO PER POLIURETANO E GOMMA

Adatto per tagliare tubi in pe, pu e gomma.
manico bi-componente



Apertura max 19 mm
Lunghezza 133 mm

0092 € 6,20

TAGLIATUBO PER TUBI RAME



Capacità 3 ÷ 28 mm - 1/8" ÷ 1 1/8"

0297 € 67,80

TAGLIATUBO A CRICCHETTO PER PLASTICA



Taglio massimo Ø 42 mm

0287-

TAGLIA BULLONI

Ideale per tranciare tondini di ferro, catene e una vasta tipologia di materiali ferrosi e non ferrosi



Cr-V

Art.	€	Dimensioni
0287/300	€ 16,10	300 mm - 12"
0287/350	€ 18,40	350 mm - 14" mm
0287/450	€ 23,50	450 mm - 18" mm
0287/600	€ 29,70	600 mm - 24" mm
0287/750	€ 38,50	750 mm - 30" mm

**0846/150**

€ 116,00

TAGLIACAVI MANUALE A CRICCHETTO

Per cavi elettrici



Capacità di taglio	150 mm ² (Al - Cu)
Lunghezza	250 mm

0801

€ 6,90

SPELLACAVO

Taglio massimo	Ø 0,8 ÷ 28,0 mm
----------------	-----------------

0513

€ 11,30

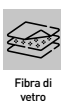
SCURETTO CON MANICO IN FIBRA DI VETRO**0842**

€ 36,40

INNESTATRICE UNIVERSALE**0862**

€ 6,90

SPELLAFILO AUTOMATICO REGOLABILE

Taglio massimo	Ø 0,8 ÷ 3,5mm 0,25 ÷ 6 mm ²
----------------	--

0101/500

€ 8,90

SCURETTO**0515**

€ 25,80

SCURE CON MANICO IN FIBRA DI VETRO

Lunghezza	900 mm
-----------	--------

0322

€ 44,50

TAGLIARAMI TELESCOPICO A CRICCHETTO CON LAMA TEMPERATA E RIVESTITA IN TEFLON

Impugnatura antiscivolo ed ergonomica.



Lunghezza	690 - 1030 mm
-----------	---------------

0587-

PUNTI METALLICI



Art.	€	Serie	Misura
0587/8006	€ 6,90	80	12,9 x 6h mm
0587/8008	€ 8,00	80	12,9 x 8h mm
0587/8010	€ 8,70	80	12,9 x 10h mm
0587/8012	€ 9,50	80	12,9 x 12h mm
0587/8014	€ 10,20	80	12,9 x 14h mm
0587/8016	€ 11,10	80	12,9 x 16h mm

0585-

PUNTI METALLICI



Art.	€	Serie	Misura
0585/9013	€ 7,00	90	5,7 x 13h mm
0585/9019	€ 9,90	90	5,7 x 19h mm
0585/9032	€ 12,50	90	5,7 x 32h mm
0585/9040	€ 13,40	90	5,7 x 40h mm

0584-

CHIODI METALLICI



Art.	€	Serie	Misura
0584/F10	€ 6,90	TI-PIN	1 x 10h mm
0584/F15	€ 8,00	TI-PIN	1 x 15h mm
0584/F20	€ 10,20	TI-PIN	1 x 20h mm
0584/F25	€ 10,90	TI-PIN	1 x 25h mm
0584/F30	€ 12,20	TI-PIN	1 x 30h mm
0584/F35	€ 13,40	TI-PIN	1 x 35h mm
0584/F40	€ 15,10	TI-PIN	1 x 40h mm
0584/F45	€ 15,30	TI-PIN	1 x 45h mm
0584/F50	€ 15,60	TI-PIN	1 x 50h mm

0588-

SPILLI



Art.	€	Serie	Misura
0588/615	€ 7,50	0,60	0,63 x 15h mm
0588/620	€ 9,30	0,60	0,63 x 20h mm
0588/625	€ 10,90	0,60	0,63 x 25h mm

0151

€ 2,99

GRAFFE



Sezione 0,58 x 1,2 mm

0295

€ 10,80

ASSORTIMENTO RIVETTI

25 Pz 2.4x6.4 mm; 25 Pz 2.4x8 mm; 25 Pz 3.2x5 mm; 25 Pz 3.2x6.4 mm; 25 Pz 3.2x8 mm; 25 Pz 4x6.4 mm; 25 Pz 4x8 mm; 25 Pz 4.8x6.4 mm; 25 Pz 4.8x8 mm;



0376/AC

€ 9,90

RIVETTI FILETTATI IN ACCIAIO

Al carbonio, tropicalizzati, M3: 40 Pz - M4: 40 Pz - M5: 30 Pz - M6: 20 Pz - M8: 10 Pz - M10: 5 Pz - M12: 5 Pz.



Rivetti filettati M3 - M4 - M5 - M6 - M8 - M10 - M12

**0376/AL**

€ 12,40

RIVETTI FILETTATI IN ALLUMINIO

M4: 50 Pz - M5: 35 Pz - M6: 15 Pz - M8: 10 Pz
- M10: 10 Pz



120 Pcs



Append.



Alu

Alluminio



Rivetti filettati

M4 - M5 - M6 - M8 - M10

0376/AI

€ 34,70

RIVETTI FILETTATI IN ACCIAIO INOX

M3: 40 Pz - M4: 40 Pz - M5: 30 Pz - M6: 20 Pz -
M8: 10 Pz - M10: 5 Pz - M12: 5 Pz



150 Pcs



Append.



INOX



Rivetti filettati

M3 - M4 - M5 - M6 - M8 - M10 - M12

0178

€ 10,50

ASSORTIMENTO RONDELLE

50 Pz Grower #6; 50 Pz Grower #8; 50 Pz
Grower #10; 40 Pz Grower 1/4"; 30 Pz Grower
5/16"; 20 Pz Grower 3/8"; 50 Pz Dent. est. #6;
50 Pz Dent. est. #8; 50 Pz Dent. est. #10; 40
Pz Dent. est. 1/4"; 30 Pz Dent. est. 5/16"; 20
Pz Dent. est. 3/8"; 50 Pz Dent. int. #6; 50 Pz
Dent. int. #8; 50 Pz Dent. int. #10; 40 Pz Dent.
int. 1/4"; 30 Pz Dent. int. 5/16"; 20 Pz Dent.
int. 3/8";



720 Pcs



Scatola



Alu

Alluminio

**0229**

€ 15,60

ASSORTIMENTO RONDELLE IN RAME

30 Pz M6; 25 Pz M8; 20 Pz M10; 15 Pz M12; 10
Pz M14; 10 Pz M16;



110 Pcs



Scatola

**0294**

€ 11,10

ASSORTIMENTO COPPIGLIE

150 Pz 1/16" x 1"; 150 Pz 3/32" x 1"; 100 Pz
3/32" x 1 - 1/2"; 1/8" x 1-1/4"; 50 Pz 1/8" x 2"; 30
Pz 5/32" x 2-1/2".



555 Pcs



Scatola



Acciaio

**0298**

€ 10,20

ASSORTIMENTO COPPIGLIE DI SICUREZZA

42 Pz 3/32"x1-3/16"; 30 Pz 5/64"x1-5/16"; 25
Pz 5/64"x1-9/16"; 25 Pz 7/64"x1-5/18"; 20 Pz
9/64"x1-3/4"; 8 Pz 5/32"x2-15/16";



150 Pcs



Scatola



Acciaio

**0231**

€ 11,20

ASSORTIMENTO SPINE ELASTICHE

4 Pz 4x16 mm; 4 Pz 4x26 mm; 4 Pz 4x40 mm;
4 Pz 6x16 mm; 4 Pz 6x32 mm; 4 Pz 6x45 mm;
4 Pz 8x20 mm; 4 Pz 8x40 mm; 4 Pz 8x50 mm;
4 Pz 2x6 mm; 4 Pz 2x14 mm; 4 Pz 2x26 mm; 4
Pz 1.5x5 mm; 4 Pz 1.5x20 mm; 4 Pz 1.5x8 mm;
4 Pz 2.5x16 mm; 4 Pz 2.5x24 mm; 4 Pz 2.5x32
mm; 5 Pz 3x16 mm; 5 Pz 3x26 mm; 5 Pz 3x32
mm; 2 Pz 10x20 mm; 2 Pz 10x40 mm; 2 Pz
10x50 mm; 4 Pz 5.5x32 mm; 4 Pz 5.5x45 mm;
4 Pz 5.5x16 mm; 5 Pz 5x16 mm; 5 Pz 5x26 mm;
5 Pz 5x32 mm;



120 Pcs



Scatola



Acciaio

**0296**

€ 11,10

ASSORTIMENTO ANELLI ELASTICI PER ESTERNI

30 Pz 1/16"; 30 Pz 1/8"; 40 Pz 3/16"; 50 Pz 1/4";
50 Pz 3/8"; 40 Pz 1/2"; 20 Pz 5/8"; 20 Pz 3/4";
20 Pz 7/8";



300 Pcs



Scatola



Acciaio



0179

€ 10,20

ASSORTIMENTO ANELLI ELASTICI

3 Pz ø 32; 5 Pz ø 25; 5 Pz ø 22; 10 Pz ø 16; 10 Pz ø 14; 10 Pz ø 10; 5 Pz R14; 10 Pz R12; 10 Pz R10; 10 Pz ø 9; 10 Pz ø 8; 12 Pz ø 6;



0263

€ 13,40

ASSORTIMENTO CHIAVETTE A DISCO

10 Pz 4x7.5x19 mm; 10 Pz 5x7.5x19 mm; 10 Pz 3x5x13 mm; 10 Pz 3x6.5x16 mm; 10 Pz 4x5x13 mm; 10 Pz 4x6.5x16 mm; 10 Pz 5x9x22 mm; 10 Pz 6x9x22 mm;

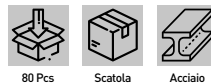

0257

€ 13,40

ASSORTIMENTO CHIAVETTE PARALLELE

5 Pz 6x6x20 mm; 4 Pz 3x3x20 mm; 4 Pz 3x3x25 mm; 5 Pz 8x5x32 mm; 5 Pz 5x5x20 mm; 5 Pz 8x7x36 mm; 5 Pz 5x5x25 mm; 5 Pz 10x8x40 mm; 5 Pz 5x5x36 mm; 5 Pz 10x8x50 mm; 5 Pz 6x6x36 mm; 2 Pz 12x8x40 mm; 5 Pz 6x6x50 mm;



0116

€ 11,10

ASSORTIMENTO SFERE D'ACCIAIO CROMATE METRICHE

Grado DIN 5401, classe III 50 Pz 2.00mm; 50 Pz 2.50mm; 50 Pz 3.00mm; 50 Pz 3.50mm; 50 Pz 4.00mm; 50 Pz 4.50mm; 50 Pz 5.00mm; 30 Pz 5.50mm; 30 Pz 6.00mm; 20 Pz 7.00mm; 20 Pz 8.00mm.



0116P

€ 13,80

ASSORTIMENTO SFERE D'ACCIAIO CROMATE IN POLLICI

Grado DIN 5401, classe III 50 Pz 3/32"; 50 Pz 1/8"; 50 Pz 5/32"; 50 Pz 3/16"; 50 Pz 7/32"; 50 Pz 1/4"; 30 Pz 9/32"; 30 Pz 5/16"; 30 Pz 11/32"; 20 Pz 3/8"; 20 Pz 13/32";



0180

€ 11,10

ASSORTIMENTO MOLLE

8 a Compress. 12 a Traz. 10Pz Comp.9/32"x 1/2"; 10Pz Ext.13/64"x 13/16"; 10Pz Comp.3/8"x 5/8"; 10Pz Ext.5/16"x 1-1/8"; 10Pz Comp.1/4"x 13/32"; 1Pz Ext.7/32"x 1"; 10Pz Comp.3/8"x 3/4"; 10Pz Comp.7/32"x 11/16"; 10Pz Ext.1/4"x 7/8"; 10Pz Ext.5/16"x 1-1/4"; 10Pz Ext.11/32"x 1-27/32"; 10Pz Ext.5/16"x 1-3/4"; 10Pz Ext.9/32"x 2"; 10Pz Ext.5/32"x 3-1/8"; 10Pz Comp.23/64"x 1-3/8"; 10Pz Ext.3/16"x 1-3/4"; 10Pz Comp.7/32"x 1-1/2"; 10Pz Ext.9/32"x 1-1/2"; 10Pz Comp.9/32"x 3/4"; 10Pz Ext.11/32"x 1-7/16";



0299

€ 21,10

ASSORTIMENTO OR METRICI

419 pezzi in 32 misure diverse realizzati in gomma nitrilica NBR di alta qualità, resistente al calore, resistente all'olio, resistente ai gas.



0299/P

€ 21,10

ASSORTIMENTO OR IN POLLICI

Assortimento realizzato in gomma nitrilica NBR di alta qualità, resistente al calore, resistente all'olio, resistente ai gas.





0177

€ 10,80

ASSORTIMENTO OR

10 Pz 3/32" x 15/64"; 20 Pz 1/8" x 1/4"; 20 Pz 5/32" x 9/32"; 20 Pz 3/16" x 5/16"; 15 Pz 7/32" x 11/32"; 15 Pz 1/4" x 3/8"; 10 Pz 9/16" x 3/4"; 10 Pz 5/8" x 13/16"; 10 Pz 11/16" x 7/8"; 10 Pz 3/4" x 15/16"; 10 Pz 3/4" x 1"; 10 Pz 13/16" x 11/16"; 15 Pz 5/16" x 7/16"; 10 Pz 3/8" x 1/2"; 10 Pz 5/8" x 3/4"; 10 Pz 3/8" x 9/16"; 10 Pz 7/16" x 5/8"; 10 Pz 1/2" x 11/16";

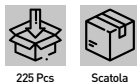

225 Pcs

Scatola



0261

€ 9,30

SERIE FASCETTE

2 Pz 12.8x0.9x50-70 mm; 4 Pz 12.8x0.9x35-50 mm; 8 Pz 12.8x0.9x25-40 mm; 6 Pz 10x0.8x12-22 mm;

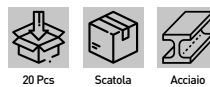

20 Pcs

Scatola

Acciaio



Dimensioni 10 x 0,8 x 12-22 mm; 12,8 x 0,9 x 25-40 mm; 12,8 x 0,9 x 35-50 mm; 12,8 x 0,9 x 50-70 mm

0876

€ 12,20

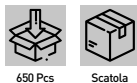
ASSORTIMENTO FASCETTE

650 Pcs

Scatola

300 Pz	2,5 x 100 mm
200 Pz	3,6 x 150 mm
150 Pz	4,8 x 200 mm



0398

€ 9,50

ASSORTIMENTO PIASTRINE A U CON VITI

Viti: 3x8mm 40Pz 4x16mm 20Pz 5x12mm 15Pz 6x20mm 10Pz Piastrine a U: 3mm 20Pz 4mm con tacca 20Pz 4mm 20Pz 5mm 15Pz 6mm 10Pz.



170 Pcs

Scatola

Acciaio



0465

€ 8,90

ASSORTIMENTO PASSACAVI IN GOMMA

Misure passacavi: 5 Pz - D 21 mm - ID 15 mm - OD 26 mm - T 2,2 mm 40 Pz - D 9 mm - ID 6 mm - OD 13 mm - T 2,1 mm 5 Pz - D 15 mm - ID 12 mm - OD 19 mm - T 1,9 mm 40 Pz - D 5,8 mm - ID 2,5 mm - OD 7,9 mm - T 1,8 mm 40 Pz - D 7,5 mm - ID 4,8 mm - OD 9,8 mm - T 1,8 mm 20 Pz - D 12 mm - ID 10,5 mm - OD 15 mm - T 1,8 mm 25 Pz - D 11 mm - ID 8,5 mm - OD 14,5 mm - T 1,5 mm 5 Pz - D 25 mm - ID 18 mm - OD 32 mm - T 1,5 mm

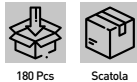

180 Pcs

Scatola



0468

€ 9,90

ASSORTIMENTO STAFFE PIATTE E AD ANGOLO CON VITI

4 Pz staffe ad angolo: 25x25x16x2,0mm 8 Pz staffe ad angolo: 40x40x16x2,0mm 4 Pz staffe ad angolo: 60x60x16x2,0mm 4 Pz staffe ad angolo: 75x75x16x2,0mm 4 Pz staffe piatte a L: 40x40x12x2,0mm 4 Pz staffe piatte a L: 60x60x12x2,0mm 4 Pz staffe piatte: 80x15x2,0mm 4 Pz staffe piatte: 40x15x2,0mm 144 Pz viti: 3x16mm

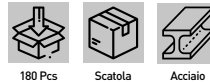

180 Pcs

Scatola

Acciaio



0307/1

€ 19,80

ASSORTIMENTO FUSIBILI IN VETRO

Rapidi: 10 x 1A F1, 10 x 1.25A F1, 10 x 1.6A F1, 10 x 2A F1, 10 x 2.5A F1, 10 x 4A F1, 10 x 5A F1, 10 x 6.3A F1, 10 x 10A F1, ritardati: 10 x 1A F1 T, 10 x 1.25A F1 T, 10 x 1.6A F1 T, 10 x 2A F1 T, 10 x 2.5A F1 T, 10 x 4A F1 T, 10 x 5A F1 T, 10 x 6.3A F1 T, 10 x 10A F1 T.



180 Pcs

Append.



Dimensioni 5 x 20 mm

0307/2

€ 22,30

ASSORTIMENTO FUSIBILI IN VETRO

Ritardati: 10 Pz 100mA T, 10 Pz 160mA T, 10 Pz 200mA T, 10 Pz 250mA T, 10 Pz 315mA T, 10 Pz 400mA T, 10 Pz 500mA T, 10 Pz 630mA T, 10 Pz 800mA T, rapidi: 10 Pz 100mA F, 10 Pz 160mA F, 10 Pz 200mA F, 10 Pz 250mA F, 10 Pz 315mA F, 10 Pz 400mA F, 10 Pz 500mA F, 10 Pz 630mA F, 10 Pz 800mA F.



180 Pcs

Append.



Dimensioni 5 x 20 mm

0317

€ 11,90

ASSORTIMENTO FUSIBILI AUTO

3A 15 Pz, 5A 15 Pz, 7.5A 15 Pz, 10A 15 Pz, 15A 15 Pz, 20A 15 Pz, 25A 15 Pz, 30A 15 Pz, Fuse puller 1 Pz.

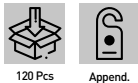

120 Pcs Append.



Dimensioni 19.1 x 5.1 x 18.5 mm

0318

€ 12,80

ASSORTIMENTO FUSIBILI AUTO

2 AMP x 10 pz; 3 AMP x 10 pz; 4 AMP x 10 pz; 5 AMP x 10 pz; 7.5 AMP x 20 pz; 10 AMP x 10 pz; 15 AMP x 20 pz; 20 AMP x 20 pz; 25 AMP x 20 pz; 30 AMP x 10 pz; Fuse Puller x 1

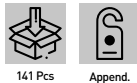

141 Pcs Append.



Dimensioni 10.9 x 3.6 x 16.3 mm

0293

€ 14,50

ASSORTIMENTO CAPICORDA

15 Pz FDD1-110 2.8x0.5/0.8 mm; 15 Pz FDD1-187 4.75x0.5/0.8 mm; 10 Pz FDD2-187 6.35x0.5/0.8 mm; 15 Pz FDD1-250 4.75x0.5/0.8 mm; 10 Pz FDD2-250 6.35x0.8 mm; 10 Pz FDD5-250 6.35x0.8 mm; 10 Pz BV1; 10 Pz BV2; 10 Pz BV5; 10 Pz MDD1-250; 10 Pz MDD2-250; 10 Pz MDD5-250; 10 Pz SVL1.25-3.7; 10 Pz SVL1.25-4; 10 Pz SVL1.25-5.3; 10 Pz SVM2-4; 10 Pz SVS2-5; 10 Pz SVL5-4; 10 Pz SVL5.5-4;

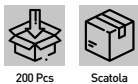

200 Pcs Scatola



0877

€ 11,30

ASSORTIMENTO TERMINALI

50 Pz 0.5mm²; 100 Pz 0.75mm²; 100 Pz 1.0 mm²; 100 Pz 1.5 mm²; 50 Pz 2.5 mm²;

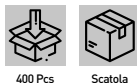

400 Pcs Scatola



Terminale Bianco	50 x 0,5 mm ²
Terminale Grigio	100 x 0,75 mm ²
Terminale Rosso	100 x 1 mm ²
Terminale Nero	100 x 1,5 mm ²
Terminale Blu	50 x 2,5 mm ²

0380

€ 10,20

ASSORTIMENTO GUAINE TERMORESTRINGENTI

30 Pz 5/64"x1-9/16"; 25 Pz 3/32"x1-9/16"; 20 Pz 1/8"x1-9/16"; 30 Pz 3/16"x1-9/16"; 16 Pz 9/32"x3-1/8"; 8 Pz 3/8"x3-1/8"; 8 Pz 1/2"x3-3/8";

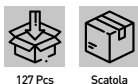

127 Pcs Scatola



0176

€ 31,80

ASSORTIMENTO INGRASSATORI

Pz. 35 dritti M6x1; Pz. 15 dritti 1/8"-27; Pz. 5 45° 1/8"-27; Pz. 5 45° M6x1; Pz. 10 45° M8x1; Pz. 5 45° M10x1; Pz. 10 dritti M10x1; Pz. 10 dritti M8x1; Pz. 5 90° M6x1; Pz. 5 90° M8x1; Pz. 5 90° M10x1.

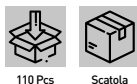

110 Pcs Scatola



SR44W

€ 5,50

BATTERIE PER STRUMENTI DIGITALI



Append.

Voltaggio	1,5 V
Pack	10



CR20X

BATTERIE PER STRUMENTI DIGITALI

Art.	€	Voltaggio	Pack
CR2025	€ 7,60	3 V	10
CR2032	€ 7,60	3 V	10





0678

€ 20,10

PISTOLA PER SCHIUMA POLIURETANICA

Regolazione del flusso resina e della ghiera filettata di montaggio bombola



Scatola

Lunghezza

290 mm

0085

PRO € 12,30**PISTOLA SILICONE SUPER RINFORZATA**

Nichelata

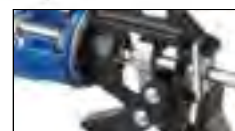

0521

PRO € 9,90**PISTOLA SILICONE SUPER RINFORZATA**

Nichelata



0234

€ 4,30

PISTOLA SILICONE A DOPPIO STELO RINFORZATA, ASTA ESAGONALE

Acciaio



0091

€ 3,75

PISTOLA SILICONE A CREMAGLIERA

0604

€ 20,10

PISTOLA PER TASSELLI CHIMICI DA 345 ML E 235 ML

Nichelata



0861 € 20,10

PISTOLA PER TASSELLI CHIMICI DA 380ML



Nichelata

0819-

CAZZUOLA PUNTA TONDA



Acciaio



Art.	€	Lunghezza
0819/18	€ 4,84	180 mm
0819/20	€ 5,00	200 mm

0820-

CAZZUOLA PUNTA QUADRA



Acciaio



Art.	€	Lunghezza
0820/18	€ 4,84	180 mm
0820/20	€ 5,00	200 mm

0821/14 € 3,75

CAZZUOLINO PUNTA TONDA



Acciaio



Lunghezza	140 mm
-----------	--------

0822 € 5,40

FRATTONE PER STUCCATORI CON MANICO IN ABS



Acciaio



Lunghezza	280 x 120 mm
-----------	--------------

0823 € 5,40

FRATTONE PER COLLA CON MANICO IN ABS



Acciaio



Lunghezza	280 x 120 mm
-----------	--------------

0184-

SPATOLA CON MANICO IN PLASTICA LUCIDATA A SPECCHIO



INOX

Art.	€	Dimensioni lama
0184/01	€ 1,49	30 x 90h mm
0184/02	€ 1,49	50 x 95h mm
0184/03	€ 1,93	75 x 100h mm
0184/04	€ 2,96	100 x 100h mm

0606 € 4,37

SECCHIO IN POLIETILENE



Dimensioni	ø 360 x 240h mm
Capacità	14 l



0043 € 5,70

NASTRO SEGNALETICO ROSSO E BIANCO



Lunghezza 200 m
Altezza 70 mm

0747 € 2,52

NASTRO PER IMBALLAGGIO IN PPL COLOR AVANA



Dimensioni nastro 50 mm x 66 m
Pack 6

PVC300/125 € 5,20

FILM ESTENSIBILE PER IMBALLAGGIO



Dimensioni 0,125h x 100 m
Spessore 20 µm
Pack 48

PVC300 € 19,60

FILM ESTENSIBILE PER IMBALLAGGIO



Dimensioni 0,5h x 300 m
Spessore 23 µm
Pack 6

0103 € 8,70

DISPENSER PER NASTRI DA IMBALLAGGIO



Scatola

0760 € 8,70

MANIGLIA PER FILM ESTENSIBILE



0748 € 10,30

MANIGLIA PER FILM ESTENSIBILE

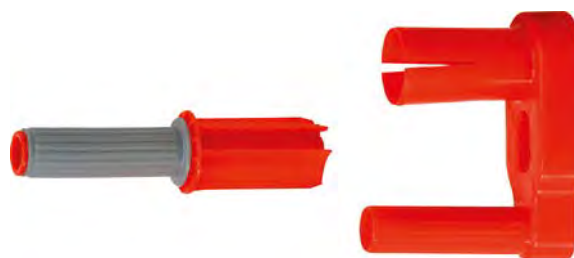

028X

TELO IN POLIETILENE PESANTE ANELLATO BORDATO, BICOLORE VERDE - BLU

Stabilizzato ai raggi uv, telone tessuto in polietilene, 140/150 g/m2, occhielli metallici ogni 50cm.



Art.	€	Dimensioni	Peso netto
0281	€ 11,80	2 x 3 m	0,9 kg
0282	€ 34,10	4 x 5 m	2,8 kg
0283	€ 68,10	5 x 8 m	5,6 kg
0284	€ 88,80	6 x 10 m	8 kg

C190C

€ 1250,00

CARRELLO A 7 CASSETTI COMPLETO DI UTENSILI

152 utensili, con sistema antiribaltamento. si può aprire un solo cassetto alla volta; piano di lavoro in materiale plastico e legno con pratici scomparti, mensola a scomparsa e vano porta attrezzi o bombole su di un lato, porta cacciaviti e vano porta attrezzi o bombole sull'altro lato



152 Pcs

Dimensioni esterne	1000 x 470 x 920h mm
Dimensioni cassetto	560 x 400 mm
Altezza cassette	2 x 40 mm - 4 x 60 mm - 1 x 170 mm

C960C

€ 978,00

CARRELLO COMPLETO DI UTENSILI



291 Pcs

Dimensioni	890 x 458 x 994 mm
Dimensioni cassetto	565 x 405 mm
Altezza cassette	5 x 74,5 mm - 2 x 153,5 mm
Portata cassetto	25 kg



C960CB

NEW € 978,00

CARRELLO COMPLETO DI UTENSILI



291 Pcs

Dimensioni	890 x 458 x 994 mm
Dimensioni cassetto	565 x 405 mm
Altezza cassette	5 x 74,5 mm - 2 x 153,5 mm
Portata cassetto	25 kg

C980/CC01

€ 1610,00

CARRELLO COMPLETO DI UTENSILI

Carrello completo di utensili con i seguenti termoformati: TM01/002, TM01/005, TM01/008, TM01/009, TM01/020, TM01/029, TM01/042.



72 Pcs

Termoformati inclusi	TM01/002, TM01/005, TM01/008, TM01/009, TM01/020, TM01/029, TM01/042
Dimensioni cassetteria	890 x 530 x 1030h mm
Portata cassetto	25 kg
Dimensioni cassetto	565 x 405 mm
Altezza cassette	3 x 50 mm - 3 x 105 mm - 1 x 165 mm

C960/CC01
€ 1130,00
CARRELLO COMPLETO DI UTENSILI

Carrello completo di utensili con i seguenti termoformati: TM01/002, TM01/010, TM01/012, TM01/014, TM01/016, TM01/018, TM01/023, TM01/025, TM01/030, TM01/033, TM01/042.



159 Pcs

Termoformati inclusi

 TM01/002, TM01/010, TM01/012, TM01/014,
 TM01/016, TM01/018, TM01/023, TM01/025,
 TM01/030, TM01/033, TM01/042

Dimensioni cassettiera

890 x 475 x 1015h mm

Portata cassetto

25 kg

Dimensioni cassetto

5640x 405 mm

Altezza cassette

5 x 65 mm - 2 x 145 mm

C900/CC01
€ 686,00
CARRELLO COMPLETO DI UTENSILI

Carrello completo di utensili con i seguenti termoformati: TM01/001, TM01/012, TM01/014, TM01/020, TM01/022, TM01/024, TM01/042.



113 Pcs

Termoformati inclusi

 TM01/001, TM01/012, TM01/014, TM01/020,
 TM01/022, TM01/024, TM01/042

Dimensioni cassettiera

685 x 455 x 850h mm

Portata cassetto

25 kg

Dimensioni cassetto

585 x 410 mm

Altezza cassette

2 x 45 mm - 2 x 100 mm - 2 x 150 mm





C960/AM01

€ 1130,00

CARRELLO COMPLETO DI UTENSILI PER L'AUTOMOTIVE



142 Pcs

Dimensioni cassetteria	890 x 475 x 1015h mm
Portata cassetto	25 kg
Dimensioni cassetto	565 x 405 mm
Altezza cassette	5 x 65 mm - 2 x 145 mm



TM01/001 € 57,90

SERIE DI CHIAVI COMBinate IN TERMOFORMATO MORBIDO

Termoformato morbido in polietilene espanso bicolor grigio-blu a 4 strati fresato con macchina cnc completo di utensili.



Dimensioni	188 x 405 x 33 mm
Misure	6 - 7 - 8 - 9 - 10 - 11 - 12 - 13 - 14 - 15 - 16 - 17 - 18 - 19 - 20 - 21 - 22 mm
Articoli inclusi	0224/..

TM01/002 € 119,00

SERIE DI CHIAVI COMBinate IN TERMOFORMATO MORBIDO

Termoformato morbido in polietilene espanso bicolor grigio-blu a 4 strati fresato con macchina cnc completo di utensili.



Dimensioni	188 x 405 x 33 mm
Misure	6 - 7 - 8 - 9 - 10 - 11 - 12 - 13 - 14 - 15 - 16 - 17 - 18 - 19 - 20 - 21 - 22 mm
Articoli inclusi	0208/..

TM01/005 € 60,80

SERIE DI CHIAVI FISSE IN TERMOFORMATO MORBIDO

Termoformato morbido in polietilene espanso bicolor grigio-blu a 4 strati fresato con macchina cnc completo di utensili.



Dimensioni	376 x 405 x 33 mm
Misure	6x7 - 8x9 - 10x11 - 12x13 - 14x15 - 16x17 - 18x19 - 20x22 - 21x23 - 24x26 - 25x28 - 30x32 mm
Articoli inclusi	0222/..

TM01/006 € 92,10

SERIE DI CHIAVI FISSE IN TERMOFORMATO MORBIDO

Termoformato morbido in polietilene espanso bicolor grigio-blu a 4 strati fresato con macchina cnc completo di utensili.



Dimensioni	376 x 405 x 33 mm
Misure	6x7 - 8x9 - 10x11 - 12x13 - 14x15 - 16x17 - 18x19 - 20x22 - 21x23 - 24x26 - 25x28 - 30x32 mm
Articoli inclusi	0201/..

TM01/056 NEW € 193,00

SERIE DI CHIAVI A CRICCHETTO COMBinate SNODATE IN TERMOFORMATO MORBIDO

Termoformato morbido in polietilene espanso bicolor grigio-blu a 4 strati fresato con macchina cnc completo di utensili. DIN 3113



Dimensioni	188 x 405 x 33 mm
Misure	8 - 9 - 10 - 11 - 12 - 13 - 14 - 15 - 16 - 17 - 18 - 19 mm
Articoli inclusi	0690/..

TM01/008 € 160,00

SERIE DI CHIAVI ESAGONALI MASCHIO A T IN TERMOFORMATO MORBIDO

Termoformato morbido in polietilene espanso bicolor grigio-blu a 4 strati fresato con macchina CNC completo di utensili.



Dimensioni	376 x 405 x 33 mm
Misure	2 - 3 - 4 - 5 - 6 - 7 - 8 - 9 - 10 - 12 - 14 mm
Articoli inclusi	0400/..

TM01/009 € 165,00

SERIE DI CHIAVI TORX A T IN TERMOFORMATO MORBIDO

Termoformato morbido in polietilene espanso bicolor grigio-blu a 4 strati fresato con macchina cnc completo di utensili.



Dimensioni	188 x 405 x 33 mm
Misure	T6 - T7 - T8 - T9 - T10 - T15 - T20 - T25 - T27 - T30 - T40 - T45 - T50
Articoli inclusi	0405/..

TM01/010 € 250,00

SERIE DI CHIAVI A T CON BUSSOLA ESAGONALE SNODATA IN TERMOFORMATO MORBIDO

Termoformato morbido in polietilene espanso bicolor grigio-blu a 4 strati fresato con macchina cnc completo di utensili.



Dimensioni	565 x 405 x 33 mm
Chiavi a T	7 - 8 - 10 - 12 - 13 - 14 - 17 - 19 mm
Chiavi esagonali	1,5 - 2 - 2,5 - 3 - 4 - 5 - 6 - 8 - 10 mm
Chiavi Torx	T10 - T15 - T20 - T25 - T27 - T30 - T40 - T45 - T50
Articoli inclusi	C395/.. - 0215 - 0220



TM01/011 € 276,00

SERIE DI CHIAVI A T CON BUSSOLA ESAGONALE SNODATA IN TERMOFORMATO MORBIDO

Termoformato morbido in polietilene espanso bicolore grigio-blu a 4 strati fresato con macchina cnc completo di utensili.



Dimensioni	565 x 405 x 33 mm
Chiavi a T	7 - 8 - 10 - 12 - 13 - 14 - 17 - 19 mm
Chiavi esagonali	1,5 - 2 - 2,5 - 3 - 4 - 5 - 6 - 8 - 10 mm
Chiavi Torx	T10 - T15 - T20 - T25 - T27 - T30 - T40 - T45 - T50
Articoli inclusi	C391/.. - 0215 - 0220

TM01/012 € 46,10

SERIE DI CHIAVI ESAGONALI CON MANICO ANATOMICO IN TERMOFORMATO MORBIDO

Termoformato morbido in polietilene espanso bicolore grigio-blu a 4 strati fresato con macchina cnc completo di utensili.

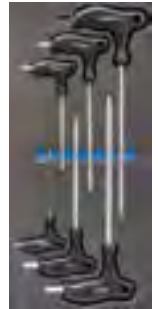
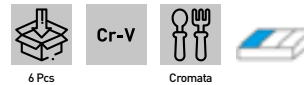

Dimensioni	188 x 405 x 33 mm
Misure	3 - 4 - 5 - 6 - 8 mm
Articoli inclusi	0856/..

TM01/014 € 46,10

SERIE DI CHIAVI TORX CON MANICO ANATOMICO IN TERMOFORMATO MORBIDO

Termoformato morbido in polietilene espanso bicolore grigio-blu a 4 strati fresato con macchina CNC completo di utensili.

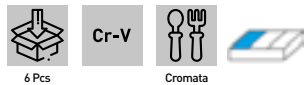

Dimensioni	188 x 405 x 33 mm
Misure	T10 - T15 - T20 - T25 - T30 - T40
Articoli inclusi	0855/..

TM01/016 € 40,20

SERIE DI GIRAVITI A TAGLIO IN TERMOFORMATO MORBIDO

Termoformato morbido in polietilene espanso bicolore grigio-blu a 4 strati fresato con macchina cnc completo di utensili.

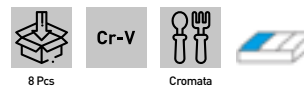

Dimensioni	188 x 405 x 33 mm
Giravite a taglio per meccanica	3 x 75 - 4 x 100 - 5 x 125 - 6 x 150 - 8 x 150 - 6 x 38 mm
Giravite a taglio elettricista	3 x 75 - 4 x 100 mm
Articoli inclusi	C883/.. - C884/..

TM01/018 € 46,10

SERIE DI GIRAVITI A CROCE IN TERMOFORMATO MORBIDO

Termoformato morbido in polietilene espanso bicolore grigio-blu a 4 strati fresato con macchina cnc completo di utensili.

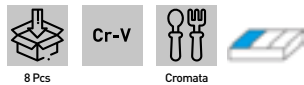

Dimensioni	188 x 405 x 33 mm
Giravite a croce per meccanica	PH 1 x 75 - PH 2 x 100 - PH 3 x 150 - PH 2 x 38 mm
Giravite a croce per viti da legno	PZ 1 x 75 - PZ 2 x 100 - PZ 3 x 150 - PZ 2 x 38 mm
Articoli inclusi	C882/.. - C885/..

TM01/020 € 41,20

SERIE DI GIRAVITI MISTI IN TERMOFORMATO MORBIDO

Termoformato morbido in polietilene espanso bicolore grigio-blu a 4 strati fresato con macchina cnc completo di utensili.

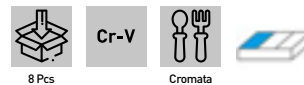

Dimensioni	188 x 405 x 33 mm
Giravite a taglio per meccanica	3 x 75 - 4 x 100 - 5 x 125 - 6 x 150 - 6 x 38 mm
Giravite a croce per meccanica	PH 1 x 75 - PH 2 x 100 - PH 2 x 38 mm
Articoli inclusi	C882/.. - C884/..

TM01/044 PRO € 50,70

SERIE DI GIRAVITI A TAGLIO DIAMANTATI IN TERMOFORMATO MORBIDO

Termoformato morbido in polietilene espanso bicolore grigio-blu a 4 strati fresato con macchina cnc completo di utensili.



Dimensioni	188 x 405 x 33 mm
Giravite a taglio per meccanica	4 x 75 - 4 x 100 - 5 x 125 - 6 x 150 - 8 x 150 - 6 x 38 mm
Giravite a taglio elettricista	3 x 75 - 4 x 100 mm
Articoli inclusi	D883/.. - D884/..

TM01/045 PRO € 57,30

SERIE DI GIRAVITI A CROCE DIAMANTATI IN TERMOFORMATO MORBIDO

Termoformato morbido in polietilene espanso bicolore grigio-blu a 4 strati fresato con macchina cnc completo di utensili.



Dimensioni	188 x 405 x 33 mm
Giravite a croce per meccanica	PH 1 x 75 - PH 2 x 100 - PH 3 x 150 - PH 2 x 38 mm
Giravite a croce per viti da legno	PZ 1 x 75 - PZ 2 x 100 - PZ 3 x 150 - PZ 2 x 38 mm
Articoli inclusi	D882/.. - D885/..

TM01/046 **PRO** € 51,30

SERIE DI GIRAVITI MISTI DIAMANTATI IN TERMOFORMATO MORBIDO

Termoformato morbido in polietilene espanso bicolore grigio-blu a 4 strati fresato con macchina cnc completo di utensili.



Dimensioni	188 x 405 x 33 mm
Giravite a taglio per meccanica	3 x 75 - 4 x 100 - 5 x 125 - 6 x 150 - 6 x 38 mm
Giravite a croce per meccanica	PH 1 x 75 - PH 2 x 100 - PH 2 x 38 mm
Articoli inclusi	D882/.. - D884/..

TM01/022 € 219,00

SERIE DI BUSSOLE ESAGONALI IN TERMOFORMATO MORBIDO

Termoformato morbido in polietilene espanso bicolore grigio-blu a 4 strati fresato con macchina cnc completo di utensili.



Dimensioni	188 x 405 x 33 mm
Bussole	8 - 9 - 10 - 11 - 12 - 13 - 14 - 15 - 16 - 17 - 18 - 19 - 20 - 21 - 22 - 23 - 24 - 25 - 26 - 27 - 28 - 29 - 30 - 32 mm
Prolunghe	75 - 250 mm
Raccordo	Femmina 1/2", maschio 3/8"
Snodi a cardano	46 mm
Leva a T scorrevole	300 mm
Articoli inclusi	BN4E3N0.. - CN450N1/2A

TM01/024 € 222,00

SERIE DI BUSSOLE ESAGONALI IN TERMOFORMATO MORBIDO

Termoformato morbido in polietilene espanso bicolore grigio-blu a 4 strati fresato con macchina cnc completo di utensili.



Dimensioni	188 x 405 x 33 mm
Bussole da 1/4"	4 - 5 - 6 - 7 - 8 - 9 - 10 - 11 - 12 - 13 - 14 mm
Bussole da 3/8"	7 - 8 - 9 - 10 - 11 - 12 - 13 - 14 - 15 - 16 - 17 - 18 - 19 - 20 - 21 - 22 mm
Articoli inclusi	BN4E5N0.. - BN4E4N0.. - CN450N1/4A - CN450N3/8A - JN40.. - LN400N.. - PN405N.. - PN404N.. - BN4C4L..

TM01/026 **PRO** € 44,10

SERIE DI GIRAVITI ISOLATI IN TERMOFORMATO MORBIDO

Termoformato morbido in polietilene espanso bicolore grigio-blu a 4 strati fresato con macchina cnc completo di utensili.

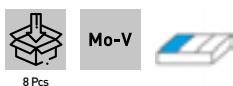

Dimensioni	188 x 405 x 33 mm
Giravite a taglio isolato	3 x 100 - 4 x 100 - 5,5 x 125 - 6,5 x 150 mm
Giravite a croce isolato	PH 0 x 60 - PH 1 x 80 - PH 2 x 100 mm
Articoli inclusi	CI82/.. - CI83/.. - 0013/142

TM01/053 **PRO** € 258,00

SERIE UTENSILI AGGIUNTIVI PER AUTOMOTIVE IN TERMOFORMATO MORBIDO

Termoformato morbido in polietilene espanso bicolore grigio-blu a 4 strati fresato con macchina CNC completo di utensili.

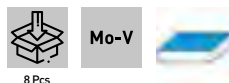

Dimensioni	565 x 405 x 33 mm
Articoli inclusi	L002/250 - 0136 - 0370/8 - 0368/10 - 0432 - 0209

TM01/023 € 214,00

SERIE DI BUSSOLE POLIGONALI IN TERMOFORMATO MORBIDO

Termoformato morbido in polietilene espanso bicolore grigio-blu a 4 strati fresato con macchina cnc completo di utensili.



Dimensioni	188 x 405 x 33 mm
Bussole	8 - 9 - 10 - 11 - 12 - 13 - 14 - 15 - 16 - 17 - 18 - 19 - 20 - 21 - 22 - 23 - 24 - 25 - 26 - 27 - 28 - 29 - 30 - 32 mm
Prolunghe	75 - 250 mm
Raccordo	Femmina 1/2", maschio 3/8"
Snodi a cardano	46 mm
Leva a T scorrevole	300 mm
Articoli inclusi	BN4P3N0.. - CN450N1/2A

TM01/025 € 218,00

SERIE DI BUSSOLE POLIGONALI IN TERMOFORMATO MORBIDO

Termoformato morbido in polietilene espanso bicolore grigio-blu a 4 strati fresato con macchina CNC completo di utensili.



Dimensioni	188 x 405 x 33 mm
Bussole da 1/4"	4 - 5 - 6 - 7 - 8 - 9 - 10 - 11 - 12 - 13 - 14 mm
Bussole da 3/8"	7 - 8 - 9 - 10 - 11 - 12 - 13 - 14 - 15 - 16 - 17 - 18 - 19 - 20 - 21 - 22 mm
Articoli inclusi	BN4P5N0.. - BN4P4N0.. - CN450N1/4A - CN450N3/8A - JN40.. - LN400N.. - PN405N.. - PN404N.. - BN4C4L..

TM01/027 € 58,80

SERIE DI CHIAVI A BUSSOLA CON IMPUGNATURA IN TERMOFORMATO MORBIDO

Termoformato morbido in polietilene espanso bicolore grigio-blu a 4 strati fresato con macchina cnc completo di utensili.

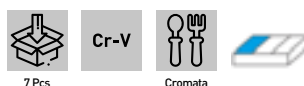

Dimensioni	188 x 405 x 33 mm
Misure	5,5 - 6 - 7 - 8 - 10 - 12 - 13 mm
Articoli inclusi	CB01/..



TM01/028

€ 70,60

SERIE DI CHIAVI A BUSSOLA CON IMPUGNATURA IN TERMOFORMATO MORBIDO

Termoformato morbido in polietilene espanso bicolore grigio-blu a 4 strati fresato con macchina cnc completo di utensili.

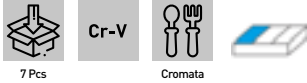

Dimensioni	188 x 405 x 33 mm
Misure	5,5 - 6 - 7 - 8 - 10 - 12 - 13 mm
Articoli inclusi	CB02/..

TM01/029

€ 67,60

SERIE DI CHIAVI A BUSSOLA FLESSIBILI CON IMPUGNATURA IN TERMOFORMATO MORBIDO

Termoformato morbido in polietilene espanso bicolore grigio-blu a 4 strati fresato con macchina cnc completo di utensili.

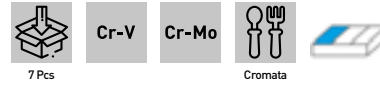

Dimensioni	188 x 405 x 33 mm
Misure	5,5 - 6 - 7 - 8 - 10 - 12 - 13 mm
Articoli inclusi	CBF1/..
Dimensioni	188 x 405 x 33 mm
Misure	Ø2x140 - Ø3x150 - Ø4x180 - Ø5x220 - Ø6x210 - Ø7x210 - Ø8x220 mm
Articoli inclusi	C015/..

TM01/030

€ 43,20

SERIE DI CHIAVI POLIGONALI IN TERMOFORMATO MORBIDO

Termoformato morbido in polietilene espanso bicolore grigio-blu a 4 strati fresato con macchina cnc completo di utensili.

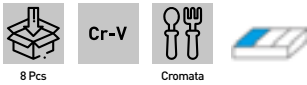

Dimensioni	188 x 405 x 33 mm
Misure	6x7 - 8x9 - 10x11 - 12x13 - 14x15 - 16x17 - 18x19 - 20x22 mm
Articoli inclusi	0476/..

TM01/031

€ 50,90

SERIE DI CHIAVI POLIGONALI IN TERMOFORMATO MORBIDO

Termoformato morbido in polietilene espanso bicolore grigio-blu a 4 strati fresato con macchina cnc completo di utensili.

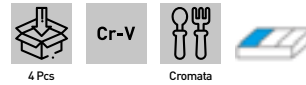

Dimensioni	188 x 405 x 33 mm
Misure	21x23 - 24x27 - 25x28 - 30x32 mm
Articoli inclusi	0476/..

TM01/032

€ 50,90

SERIE DI CHIAVI COMBinate IN TERMOFORMATO MORBIDO

Termoformato morbido in polietilene espanso bicolore grigio-blu a 4 strati fresato con macchina cnc completo di utensili.

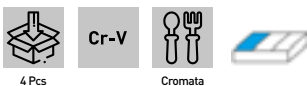

Dimensioni	188 x 405 x 33 mm
Misure	24 - 27 - 30 - 32 mm
Articoli inclusi	0224/..

TM01/033

€ 71,50

SERIE DI CHIAVI COMBinate IN TERMOFORMATO MORBIDO

Termoformato morbido in polietilene espanso bicolore grigio-blu a 4 strati fresato con macchina cnc completo di utensili.

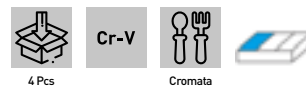

Dimensioni	188 x 405 x 33 mm
Misure	24 - 27 - 30 - 32 mm
Articoli inclusi	0208/..

TM01/035

€ 136,00

SERIE DI CHIAVI A TUBO E POLIGONALI IN TERMOFORMATO MORBIDO

Termoformato morbido in polietilene espanso bicolore grigio-blu a 4 strati fresato con macchina cnc completo di utensili.

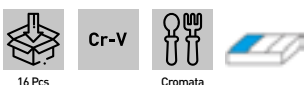

Dimensioni	188 x 405 x 33 mm
Chiavi a tubo	6x7 - 8x9 - 10x11 - 12x13 - 14x15 - 16x17 - 18x19 - 20x22 mm
Chiavi poligonali	100 - 6x7, 115 - 8x9, 130 - 10x11, 145 - 12x13, 160 - 14x15, 170 - 16x17, 185 - 18x19 - 205 - 20x22 mm
Articoli inclusi	0442/.. - 01345

TM01/036

€ 77,40

SERIE DI CHIAVI A TUBO E POLIGONALI IN TERMOFORMATO MORBIDO

Termoformato morbido in polietilene espanso bicolore grigio-blu a 4 strati fresato con macchina cnc completo di utensili.

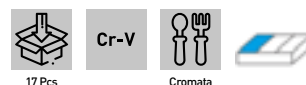

Dimensioni	188 x 405 x 33 mm
Chiavi a tubo	6x7 - 8x9 - 10x11 - 12x13 - 14x15 - 16x17 - 18x19 - 20x22 mm
Chiavi poligonali	100 - 6x7, 115 - 8x9, 130 - 10x11, 145 - 12x13, 160 - 14x15, 170 - 16x17, 185 - 18x19 - 205 - 20x22 mm
Articoli inclusi	0540/.. - 01345

TM01/037

PRO € 80,30

SERIE DI CACCIASPINE IN TERMOFORMATO MORBIDO

Termoformato morbido in polietilene espanso bicolore grigio-blu a 4 strati fresato con macchina cnc completo di utensili.



Misure	Ø2x140 - Ø3x150 - Ø4x180 - Ø5x220 - Ø6x210 - Ø7x210 - Ø8x220 mm
Articoli inclusi	C015/..

TM01/038

€ 92,10

SERIE DI CACCIASPINE IN TERMOFORMATO MORBIDO

Termoformato morbido in polietilene espanso bicolore grigio-blu a 4 strati fresato con macchina cnc completo di utensili.



Dimensioni	188 x 405 x 33 mm
Cacciaspine cilindrico	Ø2x150 - Ø3x150 - Ø4x150 - Ø5x150 - Ø6x150 - Ø7x150 - Ø8x150 mm
Bulini	4x120 - 5x150 mm
Scalpellini	18x150 - 21x200 - 25x250 mm
Martello tedesco	400g
Articoli inclusi	C012/.. - B006/.. - S022/.. - 0154/400DIN

TM01/042

PRO € 43,20

SERIE DI PINZE MISTE IN TERMOFORMATO MORBIDO

Termoformato morbido in polietilene espanso bicolore grigio-blu a 4 strati fresato con macchina cnc completo di utensili.

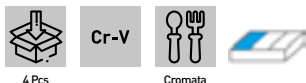

Dimensioni	188 x 405 x 33 mm
Pinza universale	180 mm
Tronchese taglio laterale	160 mm
Pinza a becchi lunghi piegati	160 mm
Pinza a becchi lunghi dritti	160 mm
Articoli inclusi	0873/U7 - 0873/BD6 - 0873/BC6 - 0873/TL

TM01/043

€ 185,00

SERIE DI BUSSOLE IMPACT IN TERMOFORMATO MORBIDO

Termoformato morbido in polietilene espanso bicolore grigio-blu a 4 strati fresato con macchina cnc completo di utensili.



Dimensioni	188 x 405 x 33 mm
Bussole	10 - 11 - 12 - 13 - 14 - 16 - 17 - 18 - 19 - 21 - 22 - 23 - 24 mm
Prolunghe	75 - 150 - 250 mm
Articoli inclusi	BI4E3N.. - PI453..

TM01/050

€ 539,00

STRUMENTI DI MISURA PER AUTOMOTIVE IN TERMOFORMATO MORBIDO

Termoformato morbido in polietilene espanso bicolore grigio-blu a 4 strati fresato con macchina cnc completo di utensili.

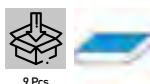

Dimensioni	565 x 405 x 33 mm
Articoli inclusi	C033/150 - C004 - 0212 - C058 - F685 - T053 - 0446 - C070 - 0312

TM01/052

€ 503,00

SERIE PNEUMATICA PER AUTOMOTIVE IN TERMOFORMATO MORBIDO

Termoformato morbido in polietilene espanso bicolore grigio-blu a 4 strati fresato con macchina CNC completo di utensili.



Dimensioni	565 x 405 x 33 mm
Articoli inclusi	AP03 - BI4E3Nx - PI453150 - 0341 - JI403N - 0608

TM01/054

NEW € 19,60

TERMOFORMATO PER A007/16



TM01/055

NEW € 19,60

TERMOFORMATO PER A007/16





TM01/100

€ 19,60

TERMOFORMATO MORBIDO PORTA MINUTERIA

Termoformato morbido in polietilene espanso bicolor grigio-blu a 4 strati fresato con macchina cnc vuoto



Dimensioni

188 x 405 x 33 mm

TM01/110

€ 29,40

TERMOFORMATO MORBIDO PORTA MINUTERIA

Termoformato morbido in polietilene espanso bicolor grigio-blu a 4 strati fresato con macchina cnc vuoto



Dimensioni

376 x 405 x 33 mm

TM01/120

€ 39,20

TERMOFORMATO MORBIDO PORTA MINUTERIA

Termoformato morbido in polietilene espanso bicolor grigio-blu a 4 strati fresato con macchina cnc vuoto



Dimensioni

564 x 405 x 33 mm



0105T

€ 303,00

VALIGIA TROLLEY CON UTENSILI E ACCESSORI



Chiavi esagonali	1,5-2-2,5-3-4-5-6-8-10 mm
Giraviti	(-) 5 x 75 - 6 x 100 mm - (+) 1 x 75 - 2 x 100 mm
Cercafasi	100 ÷ 250 V
Giraviti di precisione	(-) 2 x 140 - 2,4 x 140 - 3 x 140 - (+) 00 x 140 mm - 0 x 140 mm
Pinze	160 mm
Chiave a rullino	200 mm
Tronchese taglio laterale	160 mm
Pinze a becchi mezzitondi	160 mm
Tenaglia cementista	220 mm
Forbici multiuso	175 mm
Cacciaspina e scalpelli	5
Pinze per anelli elastici con 3 teste	1
Pinza idraulico	240 mm
Chiavi combinate	8-10-11-12-13-15-17-19-21 mm
Bussole da 1/4"	4-4,5-5-5,5-6-7-8-9-10-11-12-13-14 mm
Bussole da 1/2"	12-13-14-15-16-17-18-19-21-24-27-30-32 mm
Leva a T scorrevole	1/4"
Snodo universale	1/4" - 1/2"
Prolunghe da 1/4"	50 mm - 100 mm
Prolunghe da 1/2"	125 mm - 250 mm

Attacco da 1/2" per leva a T	1
Misure bussole per candela	16 mm - 21 mm
Leve a cricchetto	1/4" - 1/2"
Lima	200 mm
Martello tedesco	300 g
Flessometro	5 m
Mini archetto con lama	1
Lama	3
Torcia in alluminio	1
Pinza fastonatrice	200 mm
Capicorda	35
Cutter	1
Livella	300 mm
Calibro a corsoio	150 mm
Porta inserti magnetico	1
Inserti	30 - 1/4"
Porta inserti a cricchetto	1
Adattatore maschio con quadro da 1/4" e esagono da 1/4"	1
Dimensioni valigia	470 x 350 x 135 mm
Peso netto	12 kg

0110T

€ 256,00

VALIGIA CON TROLLEY, UTENSILI E ACCESSORI



Chiavi esagonali	1,5-2-2,5-3-4-5-6-8 mm
Giraviti	(-) 3 x 75 - 5 x 75 - 6 x 100 - 8 x 150 mm - (+) 0 x 75 - 1 x 75
Giraviti di precisione	(-) 2,4 x 140 - (+) 00 x 140 mm - 0 x 140 mm
Pinze	180 mm
Pinza a 2 posizioni	150 mm
Tronchese taglio laterale	115 mm
Pinze a becchi mezzitondi	150 mm
Pinza spelafili	160 mm
Forbici	200 mm
Pinza idraulico	240 mm
Chiavi combinate	6-8-10-13-14-15-17-19 mm
Bussole da 1/4"	4-5-6-7-8-9-10-11-12-13-14 mm
Bussole da 1/2"	8-9-10-11-12-13-14-15-16-17-18-19-20-21-22 mm
Leva a T scorrevole	1/4"
Snodo universale	1/4" - 1/2"
Prolunghe da 1/4"	100 mm
Prolunghe da 1/2"	250 mm
Attacco da 1/2" per leva a T	1

Misure bussole per candela	16 mm - 21 mm
Leve a cricchetto	1/4" - 1/2"
Prolunga flessibile	1/4" - 145 mm
Bussola porta inserti	1/4"
Martello tedesco	300 g
Flessometro	5 m
Mini archetto con lama	1
Capicorda	20
Cutter	1
Lama	5
Livella	300 mm
Manico per bussole	1/4"
Porta inserti magnetico	1/4"
Inserti	30 - 1/4"
Adattatore maschio con quadro da 1/4" e esagono da 1/4"	1
Dimensioni valigia	470 x 350 x 135 mm
Peso netto	10 kg



0105

€ 259,00

VALIGIA CON UTENSILI E ACCESSORI



Cr-V



Chiavi esagonali	1,5-2-2,5-3-4-5-6-8-10 mm
Giraviti	(-) 5 x 75 - 6 x 100 mm - (+) 1 x 75 - 2 x 100 mm
Cercafasi	100 ÷ 250 V
Giraviti di precisione	(-) 2 x 140 - 2,4 x 140 - 3 x 140 - (+) 00 x 140 mm - 0 x 140 mm
Pinze	160 mm
Chiave a rullino	200 mm
Tronchese taglio laterale	160 mm
Pinze a becchi mezzitondi	160 mm
Tenaglia cementista	220 mm
Forbici multiuso	175 mm
Cacciapine e scalpelli	5
Pinze per anelli elastici con 3 teste	1
Pinza idraulico	240 mm
Chiavi combinate	8-10-11-12-13-15-17-19-21 mm
Bussole da 1/4"	4-4,5-5-5,5-6-7-8-9-10-11-12-13-14 mm
Bussole da 1/2"	12-13-14-15-16-17-18-19-21-24-27-30-32 mm
Leva a T scorrevole	1/4"
Snodo universale	1/4" - 1/2"
Prolunghe da 1/4"	50 mm - 100 mm
Prolunghe da 1/2"	125 mm - 250 mm
Attacco da 1/2" per leva a T	1

Misure bussole per candela	16 mm - 21 mm
Leve a cricchetto	1/4" - 1/2"
Lima	200 mm
Martello tedesco	300 g
Flessometro	5 m
Mini archetto con lama	1
Lama	3
Torcia in alluminio	1
Pinza fastonatrice	200 mm
Capicorda	35
Cutter	1
Livella	300 mm
Calibro a corsoio	150 mm
Porta inserti magnetico	1
Inserti	30 - 1/4"
Porta inserti a cricchetto	1
Adattatore maschio con quadro da 1/4" e esagono da 1/4"	1
Dimensioni valigia	470 x 350 x 135 mm
Peso netto	11,5 kg

0110

€ 211,00

VALIGIA CON UTENSILI E ACCESSORI



Cr-V

Chiavi esagonali	1,5-2-2,5-3-4-5-6-8 mm
Giraviti	(-) 3 x 75 - 5 x 75 - 6 x 100 - 8 x 150 mm - (+) 0 x 75 - 1 x 75 - 2 x 100 x 100 mm
Giraviti di precisione	(-) 2,4 x 140 - (+) 00 x 140 mm - 0 x 140 mm
Pinze	180 mm
Pinza a 2 posizioni	150 mm
Tronchese taglio laterale	115 mm
Pinze a becchi mezzitondi	150 mm
Pinza spelafili	160 mm
Forbici	200 mm
Pinza idraulico	240 mm
Chiavi combinate	6-8-10-13-14-15-17-19 mm
Bussole da 1/4"	4-5-6-7-8-9-10-11-12-13-14 mm
Bussole da 1/2"	8-9-10-11-12-13-14-15-16-17-18-19-20-21-22 mm
Leva a T scorrevole	1/4"
Snodo universale	1/4" - 1/2"
Prolunghe da 1/4"	100 mm
Prolunghe da 1/2"	250 mm
Attacco da 1/2" per leva a T	1

Misure bussole per candela	16 mm - 21 mm
Leve a cricchetto	1/4" - 1/2"
Prolunga flessibile	1/4" - 145 mm
Bussola porta inserti	1/4"
Martello tedesco	300 g
Flessometro	5 m
Mini archetto con lama	1
Capicorda	20
Cutter	1
Lama	5
Livella	300 mm
Manico per bussole	1/4"
Porta inserti magnetico	1/4"
Inserti	30 - 1/4"
Adattatore maschio con quadro da 1/4" e esagono da 1/4"	1
Dimensioni valigia	470 x 350 x 135 mm
Peso netto	9,5 kg

0399

€ 192,00

VALIGIA CON UTENSILI E ACCESSORI

Valigia resistente con maniglia ergonomica.



Chiavi esagonali	2-2,5-3-4-5-6-8-10 mm
Giraviti	(-) 5 x 75 - 6 x 100 mm - (+) 1 x 75 - 2 x 100 mm
Pinze	150 mm
Chiave a rullino	250 mm
Tronchese taglio laterale	150 mm
Pinze a becchi mezzitondi	150 mm
Forbici multiuso	150 mm
Pinza idraulico	240 mm
Chiavi combinate	8-10-11-12-13-15-17 mm
Bussole da 1/4"	4-4,5-5-5,5-6-7-8-9-10-11-12-13-14 mm
Bussole da 1/2"	10-13-14-15-16-17-19-21-22 mm
Leva a T scorrevole	1/4"
Snodo universale	1/4" - 1/2"
Prolunghe da 1/4"	50 mm - 100 mm
Prolunghe da 1/2"	125 mm - 250 mm
Attacco da 1/2" per leva a T	1
Misure bussola per candela	16 mm - 21 mm
Leve a cricchetto	1/4" - 1/2"
Martello tedesco	300 g
Cutter	1
Porta inserti magnetico	1
Inserti	30 - 1/4"
Porta inserti a cricchetto	1
Adattatore maschio con quadro da 1/4" e esagono da 1/4"	1
Dimensioni valigia	450 x 360 x 120 mm
Peso netto	7 kg



0434

€ 93,10

VALIGIA CON UTENSILI E ACCESSORI



Chiavi esagonali	1,5-2-2,5-3-4-5-6-8-10 mm
Giraviti	(-) 5 x 75 - 6 x 100 mm - (+) 1 x 75 - 2 x 100 mm
Pinze	150 mm
Chiave a rullino	200 mm
Pinze a becchi mezzitondi	150 mm
Pinza idraulico	240 mm
Misure bussola per candela	16 mm - 21 mm
Martello tedesco	300 g
Cutter	1
Porta inserti magnetico	1
Inserti	30 - 1/4"
Porta inserti a cricchetto	1
Flessometro	5 m
Dimensioni valigia	400 x 270 x 120 mm
Peso netto	3 kg





0165

€ 255,00

VALIGIA CON UTENSILI ED ACCESSORI

175 utensili ed accessori realizzati in lega d'acciaio di cromo vanadio. Valigia con ruote e manico allungabile



175 Pcs



Scatola

Cr-V

Leve a cricchetto	1/4" - 1/2"
Chiavi a bussola per candele 1/2"	16 mm - 21 mm
Riduzione	1/2" (M) - 3/8" (F)
Porta inserti a cricchetto	1/4"
Bussola da 1/4"	4-4,5-5-5,5-6-7-8-9-10-11-12-13 mm
Porta bussole	1/4"
Bussola da 1/2"	10-11-12-13-14-15-16-17-18-19-20-21-22-23-24-27-30 mm
Leve a "T"	1/4" - 1/2"
Prolunghe da 1/4"	50 - 100 mm
Snodi a cardano	1/4" - 1/2"
Prolunga flessibile	1/4" - 150 mm
Chiavi esagonali a punta sferica	1,5-2-2,5-3-4-5-6-8-10 mm
Cercafasi	100 ÷ 250 V
Giraviti di precisione	(-) 1 - 1,4 - 1,8 - 2,4 - (+) 0 - 1
Pinze	200 - 180 - 160 mm
Chiave a rullino	200 mm
Pinza idraulico	250 mm
Chiavi combinate	6-8-10-11-12-13-14-15-17-19 mm
Martello tedesco	300 g
Flessometro	5 m
Mini archetto con lama	1
Livella magnetica	250 mm
Torcia in alluminio	1
Pinza fastonatrice	200 mm
Capicorda	50
Cutter	1
Pinza grip	175 mm
Nastro isolante	1
Calamita telescopica	1
Calibro a corsoio	150 mm
Giraviti per elettricista	(-) 5 x 125 - 4 x 100 - (+) 3 x 75 mm
Giraviti	(-) 3 x 75 - 3 x 100 - 5 x 75 - 6 x 38 - 6 x 100 mm (+) 3 x 75 - 3 x 100 - 5 x 75 - 6 x 38 - 6 x 100 - 8 x 150 mm
Porta inserti magnetico	1
Inserti	25 1/4"
Dimensioni valigetta	500 x 440 x 200/270 mm trolley mm
Carrello	1
Peso netto	15 kg



0315

€ 175,00

VALIGIA CON UTENSILI E ACCESSORI

Manico valigia ergonomico.



132 Pcs







Scatola

Cr-V







Chiavi esagonali	1,5-2-2,5-3-4-5-6-8-10 mm
Cercafasi	100 ÷ 250 V
Giraviti di precisione	(-) 1 - 1,4 - 1,8 - 2,4 - (+) 0 - 1
Pinze	200 - 180 - 160 mm
Chiave a rullino	250 mm
Pinza idraulico	250 mm
Chiavi combinate	6 - 8 - 10 - 11 - 12 - 13 - 14 - 15 - 17 - 19 mm
Martello tedesco	300 g
Flessometro	5 m
Mini archetto con lama	1
Livella magnetica	250 mm
Torcia in alluminio	1
Pinza fastonatrice	200 mm
Capicorda	50
Cutter	1
Pinza grip	175 mm
Nastro isolante	1
Calamita telescopica	1
Calibro a corsoio	150 mm
Giraviti per elettricista	(-) 5 x 125 - 4 x 100 - (+) 3 x 75 mm
Giraviti	(-) 3 x 75 - 3 x 100 - 5 x 75 - 6 x 38 - 6 x 100 mm (+) 3 x 75 - 3 x 100 - 5 x 75 - 6 x 38 - 6 x 100 - 8 x 150 mm
Porta inserti magnetico	1
Inserti	25 - 1/4"
Dimensioni valigetta	500 x 440 x 150 mm
Peso netto	9 kg



		PNEUMATICA
p. 490		— Fissatrici
p. 492		— Avvitatori
p. 495		— Smerigliatrici
p. 495		— Levigatrici
p. 498		— Pistole per soffiaggio e gonfiaggio
p. 500		— Aerografi
p. 503		— Avvolgitubo

		SALDATORI, SVERNICIATORI E PISTOLE TERMOCOLLANTI
p. 505		— Saldatori
p. 506		— Sverniciatori
p. 507		— Pistole termocollanti

		ATTREZZATURA PER LIQUIDI E FLUIDI
p. 508		— Oliatori
p. 509		— Ingrassatori
p. 510		— Spray
p. 513		— Tanche
p. 513		— Nebulizzatori
p. 514		— Pompe di travaso
		ILLUMINAZIONE E RISCALDATORI

p. 516		— Riscaldatori
p. 517		— Faretto LED
p. 518		— Lampade
p. 520		— Lenti
p. 520		— Torce e lampade a batteria
p. 525		— Avvolgicavo e multiprese

		SICUREZZA ED ANTINFORTUNISTICA
p. 526		— Detergenti ed igienizzanti
p. 527		— Guanti
p. 530		— Occhiali
p. 531		— Cantiere e primo soccorso
p. 533		— Cuffie antirumore
p. 534		— Mascherine
p. 535		— Scarpe e stivali

0149 € 30,60

GRAFFATRICE CHIODATRICE MANUALE

Con 500 punti e 500 chiodi



Blister

C586 **PRO** € 134,00

CHIODATRICE PNEUMATICA



Valigetta

Capacità caricatore	120
Pressione di esercizio	5 - 7 bar
Dimensioni	260 x 240 x 65 mm
Chiodi	F - 10 / 50 mm
Attacco aria	1/4"
Peso netto	1,3 kg

F588/6 **PRO** € 129,00

FISSATRICE PNEUMATICA PER SPILLI



Valigetta

Capacità caricatore	195
Pressione di esercizio	5 - 7 bar
Dimensioni	235 x 198 x 46 mm
Punti	0,60 - 12 / 25 mm
Attacco aria	1/4"
Peso netto	1 kg

F585 **PRO** € 139,00

FISSATRICE\CHIODATRICE PNEUMATICA



Valigetta

Capacità caricatore	100
Pressione di esercizio	5 - 7 bar
Dimensioni	255 x 230 x 67 mm
Chiodi	F - 10 / 50 mm
Punti	90 - 10 / 40 mm
Attacco aria	1/4"
Peso netto	1,4 kg

0587 € 94,80

FISSATRICE PNEUMATICA



Valigetta

Capacità caricatore	100
Pressione di esercizio	5 - 7 bar
Dimensioni	225 x 165 x 45 mm
Punti	80 - 6 / 16 mm
Attacco aria	1/4"
Peso netto	0,9 kg

0585 € 115,00

FISSATRICE\CHIODATRICE PNEUMATICA



Valigetta

Capacità caricatore	80
Pressione di esercizio	5 - 7 bar
Dimensioni	245 x 230 x 55 mm
Chiodi	F - 10 / 50 mm
Punti	90 - 10 / 40 mm
Attacco aria	1/4"
Peso netto	1,4 kg

**0586****€ 105,00****CHIODATRICE PNEUMATICA**

Valigetta

Capacità caricatore	110
Pressione di esercizio	5 - 7 bar
Dimensioni	245 x 225 x 55 mm
Chiodi	F - 10 / 50 mm
Attacco aria	1/4"
Peso netto	1,5 kg

0588/6**€ 89,50****FISSATRICE PNEUMATICA PER SPILLI**

Valigetta

Capacità caricatore	130
Pressione di esercizio	5 - 7 bar
Dimensioni	225 x 170 x 45 mm
Punti	0,60 - 12 / 30 mm
Attacco aria	1/4"
Peso netto	1 kg

C589**€ 76,60****CHIODATRICE PALMARE PNEUMATICA**

Scatola

Pressione di esercizio	5 - 7 bar
Dimensioni	111 x 115 x 70 mm
Chiodi	Ø 2.5 ÷ 4.1 - testa Ø 6.3 ÷ 8.7 - lungh. 38 ÷ 90 mm
Attacco aria	1/4"
Peso netto	0,5 kg



AP01 **PRO** € 238,00

AVVITATORE PNEUMATICO AD IMPULSI

Serie professionale. In materiale composito, impugnatura e testa in gomma antiurto. Leva di azionamento, cambio del senso di rotazione e regolazione della velocità azionabili con una mano. Alta potenza e grande affidabilità

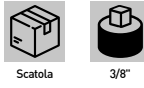

Velocità	8500 rpm
Coppia max	542 Nm 400 lb-ft
Consumo aria stimato	108 l/min 3.8 SCFM
Pressione di esercizio	6 bar 90 psi
Attacco aria	1/4"
Peso netto	1,2 kg

AP02 **PRO** € 247,00

AVVITATORE PNEUMATICO AD IMPULSI

Serie professionale. In materiale composito, impugnatura e testa in gomma antiurto. Leva di azionamento, cambio del senso di rotazione e regolazione della velocità azionabili con una mano. Alta potenza e grande affidabilità

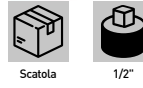

Velocità	7800 rpm
Coppia max	678 Nm 500 lb-ft
Consumo aria stimato	136 l/min 4.8 SCFM
Pressione di esercizio	6 bar 90 psi
Attacco aria	1/4"
Peso netto	1,2 kg

AP03 **PRO** € 255,00

AVVITATORE PNEUMATICO AD IMPULSI

Serie professionale. In materiale composito, impugnatura e testa in gomma antiurto. Leva di azionamento, cambio del senso di rotazione e regolazione della velocità azionabili con una mano. Alta potenza e grande affidabilità



Velocità	7300 rpm
Coppia max	1085 Nm 800 lb-ft
Consumo aria stimato	153 l/min 5.4 SCFM
Pressione di esercizio	6 bar 90 psi
Attacco aria	1/4"
Peso netto	2 kg

AP04 **PRO** € 265,00

AVVITATORE PNEUMATICO AD IMPULSI

Serie professionale. In materiale composito, impugnatura e testa in gomma antiurto. Leva di azionamento, cambio del senso di rotazione e regolazione della velocità azionabili con una mano. Alta potenza e grande affidabilità



Velocità	7300 rpm
Coppia max	1085 Nm 800 lb-ft
Consumo aria stimato	153 l/min 5.4 SCFM
Pressione di esercizio	6 bar 90 psi
Attacco aria	1/4"
Peso netto	2,1 kg

**AP05****PRO € 617,00****AVVITATORE PNEUMATICO AD IMPULSI**

Serie professionale. In materiale composito, impugnatura e testa in gomma antiurto. Leva di azionamento, cambio del senso di rotazione e regolazione della velocità azionabili con una mano. Alta potenza e grande affidabilità



Scatola

3/4"

Velocità	5300 rpm
Coppia max	1900 Nm 1400 lb-ft
Consumo aria stimato	224 l/min 8.1 SCFM
Pressione di esercizio	6 bar 90 psi
Attacco aria	3/8"
Peso netto	3,3 kg

AP05/150**PRO € 741,00****AVVITATORE PNEUMATICO AD IMPULSI**

Con incudine di 150mm serie professionale. In materiale composito, impugnatura e testa in gomma antiurto. Leva di azionamento, cambio del senso di rotazione e regolazione della velocità azionabili con una mano. Alta potenza e grande affidabilità.



Scatola

3/4"

Velocità	5300 rpm
Coppia max	1900 Nm 1400 lb-ft
Consumo aria stimato	224 l/min 8.1 SCFM
Pressione di esercizio	6 bar 90 psi
Attacco aria	3/8"
Peso netto	4 kg

AP06**PRO € 238,00****AVVITATORE PNEUMATICO AD IMPULSI**

Serie professionale. In materiale composito, impugnatura e testa in gomma antiurto. Leva di azionamento, cambio del senso di rotazione e regolazione della velocità azionabili con una mano. Alta potenza e grande affidabilità



Scatola

1/2"

Velocità	9000 rpm
Coppia max	312 Nm 230 lb-ft
Consumo aria stimato	113 l/min 4 SCFM
Pressione di esercizio	6 bar 90 psi
Attacco aria	1/4"
Peso netto	1,1 kg

0573**€ 119,00****AVVITATORE AD IMPULSI**

Scatola

3/8"

Velocità	10000 rpm
Coppia max	244 Nm
Consumo aria stimato	4 SCFM (120 l/min)
Pressione di esercizio	6 bar 90 psi
Attacco aria	1/4"
Peso netto	1,5 kg

0571 € 162,00

AVVITATORE AD IMPULSI



Velocità	7000 rpm
Coppia max	610 Nm
Consumo aria stimato	5 SCFM (150 l/min)
Pressione di esercizio	6 bar / 90 psi
Attacco aria	1/4"
Peso netto	2,6 kg

0576 € 171,00

AVVITATORE AD IMPULSI



Velocità	7000 rpm
Coppia max	435 Nm
Consumo aria stimato	5 SCFM (150 l/min)
Pressione di esercizio	6 bar / 90 psi
Attacco aria	1/4"
Peso netto	2,5 kg

0786 € 287,00

AVVITATORE AD IMPULSI



Velocità	4200 rpm
Coppia max	950 Nm
Consumo aria stimato	8 SCFM (240 l/min)
Pressione di esercizio	6 bar / 90 psi
Attacco aria	1/4"
Peso netto	4,8 kg

0044 € 94,80

SET AVVITATORE AD IMPULSI

Con 10 bussole, una prolunga per bussole, ugello da 1/4"



Velocità	7000 rpm
Coppia max	320 Nm
Bussole	9-10-11-13-14-17-19-22-24-27 mm
Prolunga	125 mm
Consumo aria stimato	5 SCFM (150 l/min)
Pressione di esercizio	6 bar/90 psi
Livello pressione acustica	84,4 ± 2,94 dB(A)
Livello vibrazione trasmessa mano braccio	8.53 ± 2.05 m/s ²
Attacco aria	1/4"
Peso netto	4 kg

0045 € 56,90

AVVITATORE AD IMPULSI



Velocità	7000 rpm
Coppia max	320 Nm
Consumo aria stimato	5 SCFM (150 l/min)
Pressione di esercizio	6 bar / 90 psi
Attacco aria	1/4"
Peso netto	2,3 kg

0052 € 134,00

AVVITATORE AD IMPULSI



Velocità	4800 rpm
Coppia max	680 Nm
Consumo aria stimato	6 SCFM (180 l/min)
Pressione di esercizio	6 bar / 90 psi
Attacco aria	1/4"
Peso netto	4,7 kg



0413

€ 30,80

MINI SMERIGLIATRICE PNEUMATICA ASSIALE

Con pinze da 3mm e 6mm. Scarico aria posteriore girevole. Corpo in materiale composito.



Scatola

Pinze	Ø 3 mm - Ø 6 mm
Velocità	25000 rpm
Consumo aria stimato	4 SCFM (113 l/min)
Pressione di esercizio	6 bar / 90 psi
Attacco aria	1/4"
Peso netto	0,4 kg

0416

€ 54,80

SMERIGLIATRICE PNEUMATICA A 90°

Con pinze da 3mm e 6mm. Scarico aria posteriore girevole. Corpo in materiale composito.



Scatola

Pinze	Ø 3 mm - Ø 6 mm
Velocità	20000 rpm
Consumo aria stimato	4 SCFM (113 l/min)
Pressione di esercizio	6 bar / 90 psi
Attacco aria	1/4"
Peso netto	0,5 kg

0418

€ 53,70

TRAPANO AD ARIA REVERSIBILE

Con mandrino da 10 mm a cremagliera. Scarico aria posteriore girevole. Corpo in materiale composito.



Scatola

Mandrino	Ø 10 mm
Velocità	1800 rpm
Consumo aria stimato	4 SCFM (113 l/min)
Pressione di esercizio	6 bar / 90 psi
Attacco aria	1/4"
Peso netto	0,9 kg

0414

€ 35,20

SMERIGLIATRICE PNEUMATICA ASSIALE

Con pinze da 3mm e 6mm, scarico aria posteriore girevole, corpo in materiale composito.



Scatola

Pinze	Ø 3 mm - Ø 6 mm
Velocità	22000 rpm
Consumo aria stimato	7 SCFM (198 l/min)
Pressione di esercizio	6 bar / 90 psi
Attacco aria	1/4"
Peso netto	0,6 kg

0417

€ 60,50

SMERIGLIATRICE PNEUMATICA ASSIALE LUNGA

Con pinze da 3 e 6mm, scarico aria posteriore girevole, corpo in materiale composito.



Scatola

Pinze	Ø 3 mm - Ø 6 mm
Lunghezza	295 mm
Velocità	20000 rpm
Consumo aria stimato	4 SCFM (113 l/min)
Pressione di esercizio	6 bar / 90 psi
Attacco aria	1/4"
Peso netto	0,6 kg

0419

€ 90,60

LEVIGATRICE PNEUMATICA ROTORBITALE DA 150MM CON ASPIRAZIONE

Regolazione della velocità, supporto disco a strappo, scarico aria posteriore girevole, corpo leggero in alluminio con impugnatura soffice ed ergonomica



Scatola

Diametro disco	150 mm - 6"
Orbita	5 mm, 3/16"
Velocità	10500 rpm MAX.
Consumo aria stimato	3 SCFM (85 l/min)
Pressione di esercizio	6 bar / 90 psi
Attacco aria	1/4"
Lunghezza	200 mm
Peso netto	1 kg

0421 € 98,60

LEVIGATRICE PNEUMATICA ROTORBITALE DA 150MM CON ASPIRAZIONE INTEGRATA

Regolazione della velocità, supporto disco a strappo, scarico aria posteriore girevole, corpo leggero in alluminio con impugnatura soffice ed ergonomica, tubo aspirazione e sacchetto raccogli polvere



Scatola

Diametro disco	150 mm - 6"
Orbita	5 mm, 3/16"
Velocità	10500 rpm
Consumo aria stimato	3 SCFM (85 l/min)
Pressione di esercizio	6 bar / 90 psi
Attacco aria	1/4"
Lunghezza	200 mm
Peso netto	1 kg

0460 € 107,00

LEVIGATRICE PNEUMATICA ROTORBITALE DA 150MM CON ASPIRAZIONE INTEGRATA

Regolazione della velocità, scarico aria posteriore girevole, corpo in alluminio ed impugnatura soffice ed ergonomica. Tubo aspirazione e sacchetto raccogli polvere.



Scatola

Diametro disco	150 mm - 6"
Orbita	2,5 mm - 3 / 32"
Velocità max di utilizzo	10500 rpm
Consumo aria stimato	3 SCFM (85 l/min)
Pressione di esercizio	6 bar / 90 psi
Attacco aria	1/4"
Lunghezza	200 mm
Peso netto	1 kg

0047 € 72,30

GIRAVITE PNEUMATICO REVERSIBILE



Scatola



1/4"

Velocità	9000 rpm
Vite	4-5 mm
Coppia max	2,3 - 6,8 Nm
Lunghezza	180 mm
Consumo aria stimato	5 SCFM (150 l/min.)
Pressione di esercizio	6 bar / 90 psi
Attacco aria	1/4"
Peso netto	0,8 kg

0458 € 90,60

LEVIGATRICE PNEUMATICA ROTORBITALE DA 150MM CON ASPIRAZIONE

Regolazione della velocità, orbita 2,5mm, supporto disco a strappo, scarico aria posteriore girevole, corpo leggero in alluminio impugnatura soffice ed ergonomica.



Scatola

Diametro disco	150 mm - 6"
Orbita	2,5 mm - 3 / 32"
Velocità max di utilizzo	10500 rpm
Consumo aria stimato	3 SCFM (85 l/min)
Pressione di esercizio	6 bar / 90 psi
Attacco aria	1/4"
Lunghezza	200 mm
Peso netto	1 kg

0046 € 89,50

AVVITATORE A CRICCHETTO CON BUSSOLE

Con 7 bussole, una prolunga fissa da 75 mm per bussole, una prolunga da 75 mm con snodo per bussole, ugello da 1/4", tre punte cacciavite e una prolunga da 75 mm fissa per punte da cacciavite.

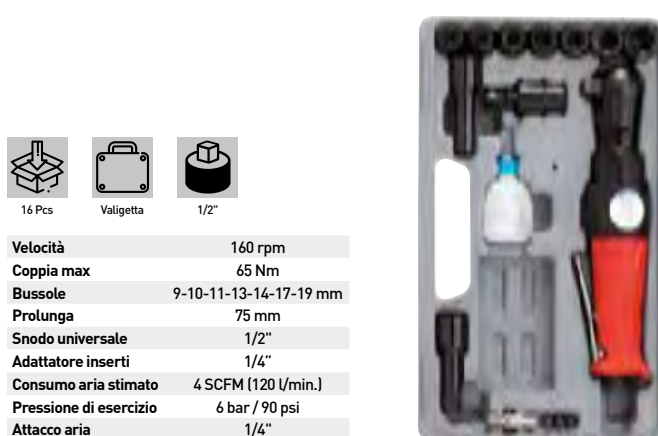

16 Pcs



Valigetta



1/2"

Velocità	160 rpm
Coppia max	65 Nm
Bussole	9-10-11-13-14-17-19 mm
Prolunga	75 mm
Snodo universale	1/2"
Adattatore inserti	1/4"
Consumo aria stimato	4 SCFM (120 l/min.)
Pressione di esercizio	6 bar / 90 psi
Attacco aria	1/4"
Peso netto	2,6 kg

0039 € 73,80

TRAPANO AD ARIA REVERSIBILE



Scatola

Mandrino	Ø 10 mm
Velocità	1800 rpm
Consumo aria stimato	5 SCFM (150 l/min.)
Pressione di esercizio	6 bar / 90 psi
Attacco aria	1/4"
Peso netto	1,1 kg



0574

€ 98,20

TRAPANO AD ARIA REVERSIBILE

Scatola

Mandrino	Ø 10 mm
Velocità	1800 rpm
Consumo aria stimato	5 SCFM (150 l/min)
Pressione di esercizio	6 bar / 90 psi
Attacco aria	1/4"
Peso netto	1 kg

0313

€ 101,00

SMERIGLIATRICE PNEUMATICA ANGOLARE

Scatola

Disco	Ø 125 mm
Velocità	10000 rpm
Consumo aria stimato	5 SCFM (150 l/min)
Pressione di esercizio	6 bar / 90 psi
Attacco aria	1/4"
Peso netto	2 kg

0050

€ 43,30

SET SMERIGLIATRICE PNEUMATICA ASSIALE CON MOLLETTINE

13 Pcs



Valigetta

Pinze	Ø 3 mm - Ø 6 mm	Pressione di esercizio	6 bar / 90 psi
Mollettine	10 Pz / Pcs	Attacco aria	1/4"
Velocità	22000 rpm	Peso netto	1,2 kg
Consumo aria stimato	4 SCFM (120 l/min.)		

0051

€ 29,50

SMERIGLIATRICE PNEUMATICA ASSIALE

Scatola

Pinze	Ø 3 mm - Ø 6 mm
Velocità	22000 rpm
Consumo aria stimato	4 SCFM (120 l/min.)
Pressione di esercizio	6 bar / 90 psi
Attacco aria	1/4"
Peso netto	0,8 kg

0570

€ 99,30

SET SMERIGLIATRICE PNEUMATICA ASSIALE CON MOLLETTINE

Con 10 mollettine, 2 pinze, 1 ugello per l'attacco tubo di alimentazione



14 Pcs



Valigetta

Pinze	Ø 3 mm - Ø 6 mm
Mollettine	10 Pz
Velocità	21000 rpm
Potenza	0,45 hp
Consumo aria stimato	5 SCFM (150 l/min.)
Pressione di esercizio	6 bar / 90 psi
Livello pressione acustica emesso nell'ambiente	77,9 ± 3,0 dB(A)
Attacco aria	1/4"
Peso netto	1 kg

0115

€ 55,30

SMERIGLIATRICE PNEUMATICA ASSIALE

Scatola

Pinze	Ø 3 mm - Ø 6 mm
Velocità	20000 rpm
Lunghezza	295 mm
Consumo aria stimato	4 SCFM (120 l/min.)
Pressione di esercizio	6 bar / 90 psi
Attacco aria	1/4"
Peso netto	0,7 kg

0641 € 63,30

MICROSMERIGLIATRICE FLESSIBILE PNEUMATICA

Per smerigliature, molatura e smussature.

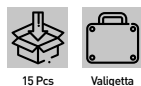

Capacità pinza	3 mm
Velocità	56000 rpm
Consumo aria stimato	2 SCFM (60 l/min.)
Pressione di esercizio	6 bar / 90 psi
Attacco aria	1/4"
Peso netto	0,7 kg



0644 € 40,90

TRONCATRICE PNEUMATICA



Disco	Ø 75 x 1,5 x Ø 10 mm	Pressione di esercizio	6 bar / 90 psi
Velocità	15000 rpm	Attacco aria	1/4"
Consumo aria stimato	5 SCFM (150 l/min.)	Peso netto	0,7 kg



0049 € 8,80

OLIATORE

Per utensili pneumatici



W021PG € 18,10

PISTOLA GONFIAGGIO



Pressione massima	12 bar (170 psi)
Pressione di esercizio	2 - 4 bar (30 - 60 psi)
Precisione	±1%
Lunghezza tubo in gomma	440 mm
Attacco aria	1/4"



0784 € 74,30

LEVIGATRICE PNEUMATICA

Con nastri di ricambio. Corpo in metallo leggero



Velocità	16000 rpm	Nastro	10 x 330 mm
Consumo aria stimato	6 SCFM (180 l/min.)	Attacco aria	1/4"
Pressione di esercizio	6 bar / 90 psi	Peso netto	0,9 kg



0059 € 34,60

MARTELLINO PESANTE CON 4 SCALPELLI ESAGONALI

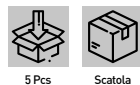

Velocità	BPM 3500	Pressione di esercizio	6 bar / 90 psi
Alesaggio-corsa	19 x 66 mm / 3/4" x 2 5/8"	Attacco aria	1/4"
Consumo aria stimato	4,5 SCFM (135 l/min)	Peso netto	1,5 kg



W021PA € 7,10

PISTOLA PER SOFFIAGGIO



Ugello	2.0 mm
Pressione di esercizio	2 - 6 bar
Attacco aria	1/4"



W021PN € 14,90

PISTOLA PER LAVAGGIO

Con corpo in alluminio e serbatoio in acciaio



Capacità	900 ml
Ugello	4.5 mm
Pressione di esercizio	3 - 4 bar
Attacco aria	1/4"





0607

€ 6,50

PISTOLA PER SOFFIAGGIO



Blister

Alu

Alluminio

Ugello	2.0 mm
Pressione di esercizio	4-6 bar
Attacco aria	1/4"



0608

€ 18,30

PISTOLA GONFIAGGIO



Blister

Manometro	Ø 63 mm
Letture	0÷12 bar 0÷174 psi
Lunghezza tubo in gomma	420 mm
Attacco aria	1/4"



0609

PRO € 44,80

PISTOLA GONFIAGGIO



Blister

Manometro	Ø 70 mm
Letture	0÷12 bar 0÷174 psi
Lunghezza tubo in gomma	1000 mm
Attacco aria	1/4"



0725L

€ 9,10

PISTOLA LUNGA PER SOFFIAGGIO



Blister

Lunghezza tubo	275 mm
Attacco aria	1/4"



0125

PRO € 37,40

PISTOLA GONFIAGGIO DIGITALE

Con retroilluminazione e cambio unità di misura. Dotato di smonta valvola.



Blister

Pressione massima	8 bar (110 psi)
Pressione di esercizio	2 - 4 bar (30 - 60 psi)
Risoluzione	0,05 bar 0,7 psi
Batterie non incluse	2 x 1.5V AAA
Lunghezza tubo in gomma	80 mm
Attacco aria	1/4"



0610

€ 15,00

PISTOLA PER LAVAGGIO



Scatola

Capacità	1000 cc
Attacco aria	1/4"



0725

€ 6,70

PISTOLA PER SOFFIAGGIO



Blister

Lunghezza tubo	100 mm
Attacco aria	1/4"



0412

€ 10,80

PISTOLA PER SOFFIAGGIO

Di alta qualità con beccuccio in acciaio cromato da 100mm Corpo in plastica POM (Polioossimetilene). Valvola in ottone.



Blister

Lunghezza tubo	100 mm
Attacco aria	1/4"



TH601A **PRO** € 151,00

AEROGRAFO CON SERBATOIO A GRAVITÀ

Aerografo HVLP con serbatoio da 600ml, serbatoio in nylon, costruita con macchine a controllo numerico, senza O-ring, ugello e spillo in acciaio inox, nebulizzatore in ottone, ghiera registri in alluminio. 1/4" HVLP = alto volume, bassa pressione.



Capacità	600 ml
Diametro ugello	1,3 mm
Portata del liquido	130 ml/min
Pressione di esercizio	2 bar (29 PSI)
Distanza di lavoro	200 mm
Ventaglio	280 - 300 mm
Attacco aria	1/4"
Peso netto	0,5 kg



TH602A **PRO** € 123,00

AEROGRAFO CON SERBATOIO A GRAVITÀ

Aerografo HVLP con serbatoio da 100ml, serbatoio in nylon, costruita con macchine a controllo numerico, senza O-ring, ugello e spillo in acciaio inox, nebulizzatore in ottone, ghiera e registri in alluminio, raccordo maschio da 1/4" HVLP = alto volume, bassa pressione.



Capacità	100 ml
Diametro ugello	1,0 mm
Portata del liquido	50 ml/min
Pressione di esercizio	1,5 bar (20 PSI)
Distanza di lavoro	150 mm
Ventaglio	160 mm
Attacco aria	1/4"
Peso netto	0,3 kg



TH901A **PRO** € 151,00

AEROGRAFO CON SERBATOIO A GRAVITÀ

Aerografo LVMP con serbatoio da 600ml, serbatoio in nylon, costruita con macchine a controllo numerico, senza O-ring, ugello e spillo in acciaio inox, nebulizzatore in ottone, ghiera registri in alluminio. LVMP = basso volume, media pressione.



Capacità	600 ml
Diametro ugello	1,3 mm
Portata del liquido	140 ml/min
Pressione di esercizio	2 ÷ 2,2 bar (29 ÷ 32 PSI)
Distanza di lavoro	200 mm
Ventaglio	270 - 300 mm
Attacco aria	1/4"
Peso netto	0,5 kg



A601DS € 101,00

AEROGRAFO CON SERBATOIO A CHIUSURA AUTOCLAVE

Aerografo HVLP, da 1000ml, serbatoio in alluminio, costruita con macchine a controllo numerico, senza O-ring, ugello e spillo in acciaio inox, nebulizzatore in ottone, ghiera registri in alluminio. HVLP = alto volume, bassa pressione.



Ugello	Ø 1,4mm
Capacità	1000 cc
Pressione di esercizio	2,5 - 3 bar
Attacco aria	1/4"
Peso netto	1,1 kg



A601A € 97,10

AEROGRAFO CON SERBATOIO A GRAVITÀ

Aerografo HVLP con serbatoio da 600ml, serbatoio in nylon, costruita con macchine a controllo numerico, senza O-ring, ugello e spillo in acciaio inox, nebulizzatore in ottone, ghiera e registri in alluminio. HVLP = alto volume, bassa pressione.



Ugello	Ø 1,4mm
Capacità	600 cc
Pressione di esercizio	2,5 - 3,5 bar
Attacco aria	1/4"
Peso netto	1 kg



A602A € 62,80

AEROGRAFO CON SERBATOIO A GRAVITÀ

Aerografo HVLP con serbatoio da 100ml, serbatoio in nylon, costruita con macchine a controllo numerico, senza O-ring, ugello e spillo in acciaio inox, nebulizzatore in ottone, ghiera e registri in alluminio. HVLP = alto volume, bassa pressione.



Ugello	Ø 1,0mm
Capacità	100 cc
Pressione di esercizio	2 - 2,5 bar
Attacco aria	1/4"
Peso netto	0,5 kg



**A901A**

€ 95,40

AEROGRAFO CON SERBATOIO A GRAVITÀ

Aerografo LVMP con serbatoio da 600ml, serbatoio in nylon, costruita con macchine a controllo numerico, senza O-ring, ugello e spillo in acciaio inox, nebulizzatore in ottone, ghiere in alluminio. LVMP = basso volume, media pressione.



Scatola

INOX

Cromata

Capacità	600 ml
Diametro ugello	1,4 mm
Portata del liquido	200-380 ml/min
Pressione massima	2-3 bar (30-43 PSI)
Attacco aria	1/4"
Peso netto	0,6 kg

**A902A**

€ 64,00

AEROGRAFO CON SERBATOIO A GRAVITÀ

Aerografo LVMP con serbatoio da 100ml, serbatoio in nylon, costruita con macchine a controllo numerico, senza O-ring, ugello e spillo in acciaio inox, nebulizzatore in ottone, ghiere in alluminio. LVMP = basso volume, media pressione.



Scatola

INOX

Cromata

Capacità	100 ml
Diametro ugello	1 mm
Portata del liquido	45 - 65 ml/min
Pressione massima	1.5 - 2.5 bar (22 - 36 PSI)
Attacco aria	1/4"
Peso netto	0,3 kg

**A162DS**

€ 38,30

AEROGRAFO CON SERBATOIO A CHIUSURA AUTOCLAVE

Copertura in alluminio



Scatola

Alu

Alluminio

Ugello	Ø 1,8 mm
Capacità	1000 cc
Pressione di esercizio	4-8 bar
Consumo aria	100-200 l/min
Attacco aria	1/4"
Peso netto	0,9 kg

**A162C**

€ 27,20

AEROGRAFO CON SERBATOIO A CHIUSURA RAPIDA

Copertura in alluminio



Scatola

Alu

Alluminio

Ugello	Ø 1,8 mm
Capacità	1000 cc
Pressione di esercizio	4-8 bar
Consumo aria	100-200 l/min
Attacco aria	1/4"
Peso netto	0,8 kg

**A162A**

€ 23,00

AEROGRAFO CON SERBATOIO A GRAVITÀ

Scatola

Ugello	Ø 1,8 mm
Capacità	500 cc
Pressione di esercizio	4-8 bar
Consumo aria	100-200 l/min
Peso netto	0,5 kg

**0048**

€ 17,40

MINI AEROGRAFO

Dotato di raccordo per bomboletta aria compressa e raccordo da 1/4" per compressore



7 Pcs



Scatola

TH250 € 15,40

REGOLATORE DI PRESSIONE

Con manometro per utensili ad aria



Blister

Manometro	Ø 40 mm
Lettura	0÷11 bar 0÷160 psi

TH500 € 26,90

REGOLATORE DI PRESSIONE

Con manometro per utensili ad aria



Blister

Manometro	Ø 30 mm
Lettura	0÷10 bar 0÷145 psi

0777/2 € 38,60

RIDUTTORE CON MANOMETRO E SEPARATORE



Scatola

Attacco	1/4" - 3/8" - 1/2"
Lettura	0÷10 bar 0÷140 psi

0777/3 € 68,50

RIDUTTORE CON MANOMETRO, SEPARATORE E OLIIATORE



Scatola

Attacco	1/4" - 3/8" - 1/2"
Lettura	0÷10 bar 0÷140 psi

0785-XM

SET 2 RUBINETTI MASCHIO UNIVERSALI



Blister

Art.	€	Attacco
0785/1M	€ 10,00	1/4"
0785/2M	€ 10,00	3/8"

0785-XF

SET 2 RUBINETTI FEMMINA UNIVERSALI



Blister

Art.	€	Attacco
0785/1F	€ 10,00	1/4"
0785/2F	€ 10,00	3/8"

0783-XM

SET 2 INNESTI RAPIDI MASCHIO TIPO TEDESCO



Blister



Acciaio



Nichelata

Art.	€	Attacco
0783/1M	€ 2,84	1/4"
0783/2M	€ 2,84	3/8"

0783-XF

SET 2 INNESTI RAPIDI FEMMINA TIPO TEDESCO



Blister



Acciaio



Nichelata

Art.	€	Attacco
0783/1F	€ 2,62	1/4"
0783/2F	€ 2,62	3/8"

**A481/10****PRO NEW € 73,40****AVVOLGITUBO AUTO RIENTRANTE PER ARIA**

In polipropilene, con tubo in poliuretano rinforzato, carrello per distribuire uniformemente il tubo all'interno dell'avvolgitubo, sfera di arresto regolabile senza attrezzi e staffa di montaggio girevole a 180°



Scatola

PP

Poliprop.

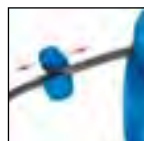

Pressione massima	16 bar / 250 psi
Lunghezza tubo	10 + 1 m
Raccordi maschio	1/4" BSPT
Diametro tubo	Ø 12 x 8 mm
Temperatura di esercizio	0 ÷ 45° C
Peso netto	2,9 kg

A481/15**PRO NEW € 113,00****AVVOLGITUBO AUTO RIENTRANTE PER ARIA**

In polipropilene, con tubo in poliuretano rinforzato, carrello per distribuire uniformemente il tubo all'interno dell'avvolgitubo, sfera di arresto regolabile senza attrezzi e staffa di montaggio girevole a 180°



Scatola

PP

Poliprop.

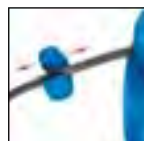

Pressione massima	16 bar / 250 psi
Lunghezza tubo	15 + 1 m
Raccordi maschio	1/4" BSPT
Diametro tubo	Ø 12 x 8 mm
Temperatura di esercizio	0 ÷ 45° C
Peso netto	4,4 kg

A481/15H**PRO NEW € 134,00****AVVOLGITUBO AUTO RIENTRANTE PER ARIA**

In polipropilene, con tubo in poliuretano rinforzato, carrello per distribuire uniformemente il tubo all'interno dell'avvolgitubo, sfera di arresto regolabile senza attrezzi e staffa di montaggio girevole a 180°



Scatola

PP

Poliprop.



Pressione massima	18 bar / 260 psi
Lunghezza tubo	15 + 1 m
Raccordi maschio	3/8" BSPT
Diametro tubo	Ø 13,5 x 9,5 mm
Temperatura di esercizio	0 ÷ 45° C
Peso netto	4,5 kg

A481/30H**PRO NEW € 200,00****AVVOLGITUBO AUTO RIENTRANTE PER ARIA**

In polipropilene, con tubo in poliuretano rinforzato, carrello per distribuire uniformemente il tubo all'interno dell'avvolgitubo, sfera di arresto regolabile senza attrezzi, sistema di ritorno a bassa velocità e staffa di montaggio girevole a 180°



Scatola

PP

Poliprop.



Pressione massima	18 bar / 260 psi
Lunghezza tubo	30 + 2 m
Raccordi maschio	3/8" BSPT
Diametro tubo	Ø 13,5 x 9,5 mm
Temperatura di esercizio	0 ÷ 45° C
Peso netto	9 kg

0378/1510**PRO € 166,00****AVVOLGITUBO AUTO RIENTRANTE PER ARIA**

Tubo in poliuretano rinforzato e carrello per distribuire uniformemente il tubo all'interno dell'avvolgitubo



Scatola

PP

Poliprop.



Pressione massima	18 bar / 260 psi
Lunghezza tubo	15 + 1 m
Raccordi maschio	3/8" BSPT
Diametro tubo	Ø 13,5 x 9,5 mm
Temperatura di esercizio	0 ÷ 45° C
Peso netto	5 kg

0481/15**€ 127,00****AVVOLGITUBO AUTO RIENTRANTE PER ARIA**

Con tubo in poliuretano rinforzato, rubinetto femmina tipo tedesco, innesto rapido femmina tipo tedesco e carrello per distribuire uniformemente il tubo all'interno dell'avvolgitubo



Scatola

ABS

Pressione massima	16 bar / 250 psi
Lunghezza tubo	15 + 1 m
Raccordi maschio	1/4" BSPT
Diametro tubo	Ø 12 x 8 mm
Temperatura di esercizio	0 ÷ 45° C
Peso netto	4,5 kg

0240/15

€ 150,00

AVVOLGITUBO AUTO RIENTRANTE PER ARIA

Tubo in poliuretano rinforzato



Scatola

Pressione massima	16 bar / 250 psi
Lunghezza tubo	15 m + 1m
Raccordi maschio	3/8" BSPT
Diametro tubo	12 x 8 mm
Peso netto	5 kg



S075-

SPIRALE IN POLIURETANO CON RACCORDO GIREVOLE MASCHIO

Art.	€	Lunghezza	Diametro	Filetto
S075/08X5	€ 12,90	7,5 m	Ø 8 x 5 mm	1/4"
S075/10X6.5	€ 18,10	7,5 m	Ø 10 x 6,5 mm	1/4"
S100/08X5	€ 15,60	10 m	Ø 8 x 5 mm	1/4"
S100/10X6.5	€ 23,00	10 m	Ø 10 x 6,5 mm	1/4"
S100/12X8	€ 25,40	10 m	Ø 12 x 8 mm	1/4"





0793 € 20,20

PIROGRAFO COMPLETO DI N°6 PUNTALINI



7 Pcs Blister

Potenza 230 V 50 Hz 30 W

0031 € 32,90

STAZIONE DI SALDATURA A TEMPERATURA CONTROLLATA

Temperatura regolabile 150°C-420°C, punta di ferro con foro Ø 6 mm



Scatola

Fusione dello stagno comune	215°
Temperatura di esercizio	215 ÷ 300°C
Temperatura massima	450°C
Alimentazione	230 V, 50 Hz, 37 W

0027/40W € 14,40

SALDATORE STILO



Blister

Alimentazione	230 V 50 Hz 40 W
Temperatura di esercizio	450°C ± 10%

0037 € 19,60

SET PER SALDATURA A STAGNO



Blister

Potenza 230V 50Hz 30W

0033A **PRO** € 112,00

STAZIONE DI SALDATURA A TEMPERATURA CONTROLLATA

Temperatura regolabile 150°C-420°C, punta di ferro con foro Ø 6 mm



Scatola



Fusione dello stagno comune	215°
Temperatura di esercizio	215 ÷ 300°C
Temperatura massima	420°C
Alimentazione stazione	230 V 50 Hz
Alimentazione saldatore	24 V 48 W

0027/30W € 12,70

SALDATORE STILO



Blister

Alimentazione	230 V 50 Hz 30 W
Temperatura di esercizio	450°C ± 10%

0033A/TIP € 18,00

SERIE PUNTE PER SALDATORE A STAGNO



4 Pcs



Appendibile

0027/40W/TIP € 18,00

SERIE PUNTE PER SALDATORE A STAGNO



4 Pcs



Appendibile

0037/TIP € 16,00

SERIE PUNTE PER SALDATORE A STAGNO

Serie punte con foro Ø 6mm.



5 Pcs



Appendibile

0864 € 45,00

MINI SALDATORE A GAS

Testa a saldare e a brasare con protezione e accensione



Blister

Dimensioni 165 x 23 mm

0443 **PRO** € 56,30

SALDATORE A PISTOLA MULTIFUNZIONE

Con regolazione della temperatura, funzione: coltello a caldo, saldatore e pirografo



Valigetta

Alimentazione 230V 50Hz 200W
Temperatura 70 °C ÷ 500 °C

0694 € 44,60

SET SVERNICIATORE

A 2 temperature, con spatola, raschietti e diffusori



10 Pcs



Valigetta

Temperatura [2] 300 °C - 600 °C
Flusso d'aria 500 l/min - 650 l/min
Potenza 230 V 50 Hz 1 - 2 kW

0865 € 63,50

ACCENDI BARBECUE ELETTRICO

Accende la carbonella nella griglia o nel camino senza bisogno di prodotti chimici o fiammiferi. Calore generato 600°C, 30 - 60 secondi per accendere.



Scatola

Alimentazione 230 V, 50 Hz, 2000 W
Temperatura 600° C

0026 € 20,00

SALDATORE ISTANTANEO

Con punta di ricambio e stagno



Blister

Potenza 230 V 50 Hz 100 W

0024 € 30,10

SVERNICIATORE



Scatola

Temperatura 300 °C - 500 °C
Flusso d'aria 280 l/min - 480 l/min
Potenza 230 V 50Hz 1,5 kW

0444 **PRO** € 84,00

SET SVERNICIATORE DIGITALE

Con regolazione elettronica della temperatura, indicazione della temperatura mediante schermo lcd, 2 livelli di flusso aria, ideale per scaldare, piegare, curvare, sverniciare



6 Pcs



Scatola

ABS

Alimentazione 230 V, 50 Hz, 2000 W
Temperatura I 70°C - II 70°C ÷ 600°C - III 70°C ÷ 600°C
Flusso d'aria I 300L/min - II 300L/min - III 500L/min

0441 € 69,90

COLTELLO A CALDO TAGLIA POLISTIROLO CON TEMPERATURA REGOLABILE

Per polistirolo, plastica, gomma piuma, spugna, profondità di taglio regolabile, supporto in metallo



Scatola

Alimentazione 230 V, 50 Hz, 220 W
Temperatura 120 - 220 - 330 - 400 - 450 °C
Capacità di taglio con regolazione 20 ÷ 90 mm
Taglio massimo 150 mm



0321

€ 47,60

COLTELLO A CALDO TAGLIA POLISTIROLO CON TEMPERATURA REGOLABILE

Per polistirolo, plastica, gomma piuma, spugna, profondità di taglio regolabile, supporto in metallo



Scatola

Alimentazione	230 V, 50 Hz, 130 W
Temperatura	Max 450 °C
Capacità di taglio con regolazione	14 ÷ 97 mm
Taglio massimo	120 mm

0706

PRO € 36,50

PISTOLA TERMOCOLLANTE AUTOMATICA

Valigetta

Alimentazione	230 V 40W 300 °C
Colla in stick	Ø 12 mm

0431

PRO € 18,00

PISTOLA TERMOCOLLANTE AUTOMATICA

Con avanzamento automatico, segnale collegamento rete elettrico a Led.



Blister

Alimentazione	230 V, 35 W, 200 °C
Colla in stick	Ø 12 mm
Flusso colla	16 ÷ 20 g/min

0333

PRO € 111,00

COLTELLO A CALDO TAGLIA POLISTIROLO CON TEMPERATURA REGOLABILE

Per polistirolo, plastica, gomma piuma, spugna, profondità di taglio regolabile, supporto in metallo



Valigetta

Alimentazione	230 V, 50 Hz, 150 W
Temperatura	Max 500 °C
Taglio massimo	150 mm

0333/150

€ 18,00

LAMA DI RICAMBIO

0034

€ 5,10

CANDELETTE DI COLLA PER PISTOLA TERMOCOLLANTE

10 Pcs



Blister

Dimensioni Ø 12 x 200 mm Tot. 200 gr

0071

€ 5,40

CANDELETTE DI COLLA PER PISTOLA TERMOCOLLANTE

10 Pcs



Blister

Dimensioni Ø 12 x 200 mm 200 gr mm

0156-

OLIATORE IN METALLO CON CANNA FLESSIBILE

Art.	€	Capacità
0156/200	€ 6,00	200 cc
0156/500	€ 7,50	500 cc



0158/500

€ 9,10

OLIATORE CON CANNA FLESSIBILE

Plastic



Capacità 500 cc

0164/250

€ 7,80

OLIATORE CON CANNA VERTICALE FLESSIBILE

Plastic

Capacità 250 cc



0473-

BACINELLA PER CAMBIO OLIO

Con beccuccio e maniglie, costruita in polietilene ad alta densità, resistente agli urti



Art.	€	Capacità	Dimensioni
0473/10	€ 19,60	10 l	Ø400 x 120h mm
0473/15	€ 21,40	15 l	Ø500 x 130h mm

0171-

BROCCA GRADUATA

Con beccuccio flessibile, coperchio avvitabile e tappo di chiusura anti-sgocciolamento

Plastic

Art.	€	Capacità
0171/2	€ 11,30	2 l
0171/3	€ 11,10	3 l
0171/5	€ 15,20	5 l



0183/750

€ 3,60

RABBOCCATORE

Plastic made in Italy

Capacità 750 cc



0172/150

€ 8,60

IMBUTO IN PLASTICA

Chiusura a vite, beccuccio flessibile, coperchi per le estremità antigocciolamento e maniglia superiore per l'appensione.

Plastic

Diametro Ø150 mm
Altezza 435 mm





0677/500

€ 18,00

INGRASSATORE MANUALE A LEVA 500CC

Composto da serbatoio e pompa in metallo, testina regolabile e tubo flessibile in PVC di 300mm, per utilizzo con grasso sfuso o cartucce di grasso di diametro Ø 53mm.



Scatola

Capacità	500 cc
Dimensioni tubo flessibile	Ø 8 x 300 mm
Pressione di esercizio	6000-8000 psi

0677/1A

€ 280,00

INGRASSATORE PNEUMATICO

Utilizzo con cartuccia Ø 55mm o grasso sfuso - con 2 cartucce di grasso, tubo rinforzato di 400mm e testina regolabile a 4 griffe.



Scatola

Capacità	800 cc
Dimensioni	Ø 60 x 500 mm
Pressione di esercizio	4 - 6 bar

0677/CG

€ 10,60

CARTUCCIA DI GRASSO

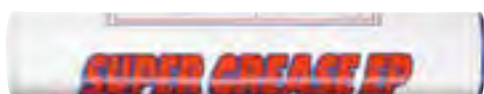

Scatola

Capacità	650 cc
Dimensioni	Ø 55 mm

0677

€ 41,00

INGRASSATORE MANUALE

Composto da serbatoio e pompa in metallo, testina regolabile e tubo flessibile in PVC di 450mm, per utilizzo cartucce di grasso di Ø 55mm o grasso sfuso (adattatore fornito montato).



Scatola

Capacità	1000 cc
Dimensioni tubo flessibile	Ø 9 x 450 mm

0677/500CG

NEW € 9,30

CARTUCCIA DI GRASSO



Scatola

Capacità	500cc
Dimensioni	Ø 53mm

0677/SO

€ 28,60

SIRINGA IN PLASTICA PER OLIO



Scatola

Plastic

Capacità	500 g
Dimensioni	Ø 50 x 500 mm

G030-

LUBROREFRIGERANTE EMULSIONABILE

Di elevata qualità, miscelabile con acqua in queste percentuali: rettifica: 2,5-3,5%, tornitura e fresatura: 3,00-4,00%, foratura profonda: 4,00-7,00%, filettatura, maschiatura e stampaggio leggero: 7-15%.



Art.	€	Quantità
G030/01	€ 12,50	1 l
G030/05	€ 50,60	5 l
G030/25	€ 240,00	25 l



S401/00

€ 7,80

SPRAY MULTIFUNZIONE

È un prodotto dalle molteplici funzioni: lubrifica, protegge, sblocca. È idrorepellente e anticorrosivo. Protegge dalle ossidazioni le parti sottoposte all'azione lavante dell'acqua, rispondendo così alle esigenze della nautica grazie all'elevato potere impermeabilizzante e idrorepellente di cui è dotato. Ideale per la manutenzione di qualsiasi parte meccanica.



Capacità 400 ml



S401/01

€ 6,60

ZINCO CHIARO

Zincante a freddo ad alto peso molecolare a base di resine di tipo sintetico. Solidifica chimicamente producendo un rivestimento metallico di elevata durezza. Protegge tutte le superfici metalliche dall'ossidazione. Forma uno strato uniforme e resistente che può essere verniciabile o lasciato come protezione finale. È ideale nei ritocchi, nella rifinitura e riparazione di parti galvanizzate.



Capacità 400 ml



S401/02

€ 5,90

GRASSO MULTIUSO

Spray composto da grassi saponificati di elevata qualità. Si tratta di un grasso ad ampio settore d'impiego, presenta una buona stabilità chimica, idrorepellenza e adesività. Protegge dall'acqua, è particolarmente stabile e resistente in ambienti salini, polverosi, alle soluzioni basiche ed acide, agli agenti atmosferici. Ideale per la lubrificazione di cuscinetti, bronzine, mozzi, snodi, perni, guide ed in generale nel settore degli autoveicoli, macchine agricole ed industriali.



Capacità 400 ml



S401/03

€ 5,30

SBLOCCANTE E SOLVENTE

Fluido sintetico penetrante ad alto potere solvente e sbloccante, libera rapidamente dadi, bulloni, giunti, filetti, cerniere ed ogni altra parte meccanica dalla ruggine e dalle ossidazioni. Rilascia inoltre un velo protettivo durevole, idrofugo e idrorepellente.



Capacità 400 ml



S401/04

€ 5,80

SILICONE LUBRIFICANTE

Soluzione a base di puro olio di silicone che possiede proprietà antiadesive distaccanti e lubrificanti sui più svariati materiali. Inoltre conferisce una buona idrorepellenza sui materiali trattati prevenendo l'accumulo di cariche elettrostatiche. È efficace come lucidante e protettivo sulle parti plastiche e protegge le guarnizioni da screpolature aumentandone la tenuta e la durata.



Capacità 400 ml



**S401/05**

€ 5,70

ANTIADESIVO PER SALDATURE

Prodotto a base di polimeri sintetici filmogeni che, grazie alle loro specifiche proprietà, impediscono il grippaggio delle gocce di saldatura a qualsiasi supporto. Inoltre il film impedisce la formazione di ossidi ed eventuali corrosioni da parte di agenti chimici. È idoneo per saldature autogene, elettriche ed a base di gas inerti. Il compost è privo di sostanze silconiche.



Capacità 400 ml

**S401/06**

€ 9,50

INOX SPRAY

È un rivestimento zincante, a base di resine alchidiche e silconiche che forma uno strato protettivo. Il prodotto è stato studiato per rimanere inalterato nel tempo e presenta una spiccata resistenza chimica alla corrosione, all'azione aggressiva degli agenti atmosferici ed inoltre una resistenza meccanica. Protettivo a rapida essiccazione.



Capacità 400 ml

**S401/08**

€ 10,00

LUBRIFICANTE SECCO AL PTFE (TEFLON)

È un lubrificante antiadesivo idrorepellente asciutto. Non trattiene la polvere, non macchia. La sua applicazione forma sulla parte trattata una pellicola di PTFE asciutta, flessibile, che aderisce tenacemente ai metalli, al legno, alla plastica, ecc.. Resiste ad una temperatura tra i -80°C e i +260°C. Protegge dalla corrosione. Ideale per catene di trasmissione, filettature, rulli, nastri, guide e utensili ad alto carico, ecc.



Capacità 400 ml

**S401/09**

€ 7,20

GRASSO AL RAME

È un prodotto composto da particelle ultra fini di rame lamellare e da speciali inibitori di corrosione. Possiede un'azione lubrificante e protettiva adatta a temperature elevate. La resistenza all'alta temperatura (1000°C), l'elevata adesività ed il potere anticorrosivo lo rendono idoneo per tutti i casi dove il calore o l'ambiente altamente corrosivo possono creare bloccaggi irreversibili: perni collettori di scarico, raccordi letati, valvole d'iniezione, rulli e catene trasportatori per forni, ecc.



Capacità 400 ml

**S401/10**

€ 6,70

OLIO DA TAGLIO

Si tratta di un nuovo prodotto studiato per applicazioni professionali specifiche nel settore della lavorazione e taglio dei metalli ad elevata durezza. L'olio utilizzato è costituito da basi minerali paraffiniche arricchite con speciali additivi EP antisaldanti. Ideale per operazioni gravose di maschiatura e filettatura di acciai particolarmente duri e legati. Adatto anche per il settore idraulico.



Capacità 400 ml

**S401/11**

€ 5,10

ARIA SPRAY

Elimina immediatamente la polvere depositata sulle superfici meno accessibili. È indicato per la pulizia di lenti, obiettivi, computer, orologeria e meccanica in genere.



Capacità 400 ml



S401/12
€ 5,60
DISSODIANTE PER CONTATTI ELETTRICI ED ELETTRONICI

Prodotto specifico per la pulizia a fondo di contatti elettrici, elettronici ed elettromagnetici. Rimuove istantaneamente l'umidità e le sostanze untuose presenti in superficie quali grasso, olio, morchie, cera e colla, lasciando la parte trattata pulita e sgrassata. Se utilizzato su superfici particolarmente delicate, potrebbe risultare aggressivo intaccando le stesse.

Capacità 400 ml

S401/13
€ 6,20
OLIO DI VASELINA

Olio ad alto grado di purezza studiato appositamente per le applicazioni che necessitano di una manutenzione periodica di lubrificazione. Indicato per lubrificare meccanismi delicati. La sua speciale formula esercita inoltre un potere protettivo duraturo.

Capacità 400 ml

S401/07
€ 5,50
PULITORE FRENI, CARBURATORI E CORPI FARFALLATI

Detergente speciale di ultima generazione particolarmente efficace per tutte le parti meccaniche che necessitano di essere sgrassate senza risciacquo come freni e frizioni. Adatto per pulire corpi farfallati e collettori di aspirazione realizzati con materiale plastico. Scioglie e rimuove rapidamente olio, grasso e ogni altro tipo di sporco. Elimina i depositi carboniosi ed oleosi dal corpo farfallato e dall'intero impianto di aspirazione. Riduce l'emissione di gas di scarico nocivi.

Capacità 500 ml

S401/14
€ 6,50
ZINCO PURO

Zincante a freddo ad alto peso molecolare a base di resine di tipo sintetico. Solidifica chimicamente producendo un rivestimento metallico di elevata durezza. Protegge tutte le superfici metalliche dall'ossidazione. Forma uno strato uniforme e resistente che può essere verniciabile o lasciato come protezione finale. Resistente agli agenti atmosferici. È ideale nei ritocchi, nella rifinitura e riparazione di parti galvanizzate.

Capacità 400 ml

S401/15
€ 6,70
LUBRIFICANTE ADESIVO PER CATENE

Lubrificante ad elevate prestazioni per la lubrificazione della catena. Prodotto testato per il settore agonistico delle competizioni di moto da corsa (strada e fuoristrada), garantisce la lubrificazione per periodi di utilizzo continuo estremamente lunghi e gravosi. Protegge da acqua e polveri. Riduce l'usura della catena, della corona, del pignone e delle parti meccaniche in movimento.

Capacità 400 ml

S401/16
€ 6,60
GRASSO AL LITIO

Contiene ossidi di litio e titanio che lo rendono idoneo e specifico nel settore nautico. Il prodotto esercita una azione lubrificante durevole in presenza di ambienti salini ed aggressivi. Resistente all'ossidazione. Il prodotto protegge la superficie da agenti corrosivi ed è indicato per agire sia a temperature elevate (220°C) che rigide (-40°C). Ideale per la lubrificazione di perni, snodi, trasmissioni, leve, sospensioni, cerniere, ed organi meccanici esposti dei motori fuori bordo e delle imbarcazioni.

Capacità 400 ml

**0660-****TANICA IN MATERIALE PLASTICO**

Con tubo flessibile, per il trasporto di liquidi infiammabili, con omologazione "un" in accordo con la direttiva europea



Plastic

Art.	€	Capacità Litri	Dimensioni	Peso netto
0660/05	€ 11,30	5	260 x 120 x 250h mm	0,5 kg
0660/10	€ 16,30	10	330 x 160 x 300h mm	0,7 kg
0660/20	€ 21,40	20	400 x 200 x 360h mm	1 kg

0189-**TANICA IN METALLO**

Per il trasporto di liquidi infiammabili, con omologazione "un" in accordo con la direttiva europea



Art.	€	Capacità Litri	Peso netto
0189/05C	€ 42,30	5	1,5 kg
0189/10C	€ 42,90	10	2,5 kg
0189/20C	€ 48,90	20	3,7 kg

0189/G**€ 1,82****GUARNIZIONE PER TANICHE**

Pack

10

0194**€ 13,50****BECCUCCIO IN METALLO**

Pack

5

0356**€ 63,30****NEBULIZZATORE CARRELLATO CON LANCIA IN OTTONE**

Con guarnizioni in FPM.



Scatola

Capacità

16 l

0303**€ 43,20****NEBULIZZATORE CON LANCIA IN OTTONE**

Con manometro e guarnizioni in FPM.



Scatola

Capacità

8 l

0274 **PRO** € 8,40

NEBULIZZATORE CON UGELLO IN OTTONE

Con guarnizioni in FPM.



Capacità 2 l

0289 € 6,10

NEBULIZZATORE CON UGELLO IN OTTONE

Guarnizioni in gomma



Capacità 2 l

P024/06 € 52,70

POMPA TRAVASO A LEVA

Per travaso fusti olio lubrificante, gasolio, kerosene, e antigelo con tubo rigido in acciaio Ø 16 x 700mm con filetto M16 x 1 e tubo di mandata in plastica.



Alu
Scatola Alluminio

Portata	6 l/min
Portata ogni pompata	0.1 l
Filetto pompa	2" / 1-1/2"

P024/15 € 62,50

POMPA TRAVASO A LEVA

Per travaso fusti olio lubrificante, gasolio, kerosene e antigelo con tubo rigido in acciaio Ø 20 x 820mm con filetto gas da 1/2" e tubo di mandata in plastica.



Alu
Scatola Alluminio

Portata ogni pompata	0.350 l
Portata	15 l/min
Filetto pompa	2" / 1-1/2"

0385 € 54,60

POMPA ROTATIVA

Per travaso fusti olio lubrificante, gasolio, kerosene e antigelo con tubo di pesca telescopico

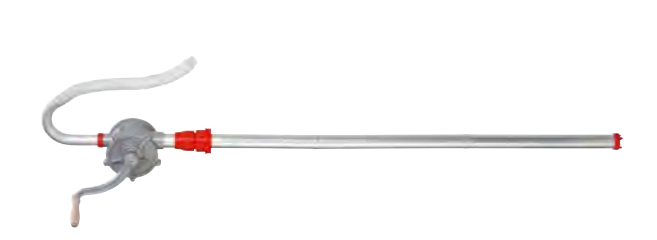

Alu
Scatola Alluminio

Portata	20 l/min
Filetto pompa	2"

0386 € 39,00

POMPA A LEVA

Per travaso fusti olio lubrificante, gasolio, kerosene e antigelo con tubo di pesca telescopico

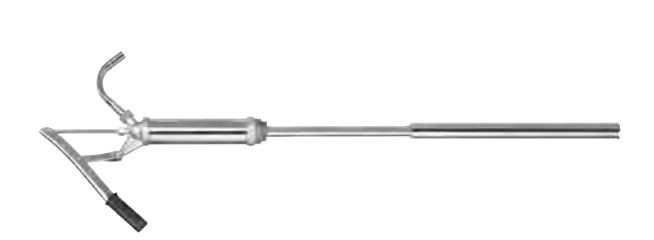

Alu
Scatola Alluminio

Portata	18 l/min
Filetto pompa	2" / 1-1/2"



0474/PP

€ 15,70

PISTOLA PER TRAVASO GASOLIO IN PVC



Scatola

Portata	60÷80 l/min
Boccaglio	Ø25 mm
Attacco di entrata	1" BSP

0474/PA

€ 74,90

PISTOLA PER TRAVASO GASOLIO AUTOMATICA

Con raccordo girevole.



Scatola

Portata	90 l/min
Boccaglio	Ø25 mm
Attacco di entrata	1" BSP

0272

€ 14,70

POMPA TRAVASO PER TRAPANO

Per liquidi non infiammabili, esplosivi, corrosivi e oleosi. utilizzo idoneo per mandrini a cremagliera



Blister

Prevalenza	30 m
Portata pompa	2.4 m ³ /h
Pressione massima	0.3 MPa
Velocità max di utilizzo	3400 rpm

0474/PE

€ 30,30

PISTOLA PER TRAVASO GASOLIO

Con raccordo girevole.



Alu

Scatola

Alluminio

Portata	60÷120 l/min
Boccaglio	Ø25 mm
Attacco di entrata	1" BSP

0755

€ 98,20

POMPA 12V PER GASOLIO

In corrente continua, per travaso gasolio e oli minerali.



Scatola

Motore	DC 12 V, 175 W
Velocità motore	4500 rpm
Portata pompa	40 l/min
Prevalenza	2 m
Aspirazione	4 m
Attacco di entrata	25 mm
Ingombro	200 x 120 x 155 mm
Tempo di utilizzo	Max 30 min

R607 € 110,00

RISCALDATORE ELETTRICO A RAGGI INFRAROSSI

Da 2000w con supporto per montaggio a parete, corpo in metallo con griglia di protezione in metallo.



Scatola

Alimentazione 230 V, 2000 W

R608 € 247,00

RISCALDATORE ELETTRICO A RAGGI INFRAROSSI

Da 2000w con supporto per montaggio a parete, corpo in metallo con griglia di protezione in metallo e controllo remoto.



Scatola

Alimentazione 230 V, 2000 W

R609 € 117,00

RISCALDATORE ELETTRICO A RAGGI INFRAROSSI CON SUPPORTO PER FISSAGGIO A PARETE DA 1300W

Da 1300w con supporto per montaggio a parete, corpo in metallo con griglia di protezione in metallo, con lampada a raggi infrarossi R75 da 1300w, 0,3m di cavo 3x1,5mm2 H07RN-F.



Scatola

Alimentazione 230 V, 1300 W

R610 € 162,00

RISCALDATORE ELETTRICO A RAGGI INFRAROSSI CON SUPPORTO PER FISSAGGIO A PARETE DA 2000W

Da 2000w con supporto per montaggio a parete, corpo in metallo con griglia di protezione in metallo, con lampada a raggi infrarossi R75 da 2000w, 0,3m di cavo 3x1,5mm2 H07RN-F.



Scatola

Alimentazione 230 V, 2000 W

R60XA

RISCALDATORE ELETTRICO A RAGGI INFRAROSSI CON TREPPIEDE



Scatola



Art.	€ Alimentazione	Altezza treppiede senza riscaldatore
R609A	€ 144,00 / 1,3 kW	600 ÷ 1500 mm
R610A	€ 207,00 / 2 kW	600 ÷ 1500 mm

R60XB

RISCALDATORE ELETTRICO A RAGGI INFRAROSSI CON SUPPORTO



Scatola



Art.	€	Alimentazione
R609B	€ 148,00	230 V 1,3 kW
R610B	€ 194,00	230 V 2 kW

T609 € 47,80

TRIPODE REGOLABILE IN ALTEZZA

Utilizzabile per faretti, riscaldatori



Scatola

Altezza 600 ÷ 1500 mm
Fissaggio superiore M 8

B609 € 30,90

BULBO A RAGGI INFRAROSSI

230V, 1300w



Scatola



Lunghezza 250 mm

B610 € 40,80

BULBO A RAGGI INFRAROSSI

230V, 2000w.



Scatola



Lunghezza 340 mm

**0218-****FARETTO LED**

Alloggiamento pressofuso in alluminio super slim, vetro temperato



Scatola

Alu

Alluminio



IP65



Art.	€	Alimentazione	Flusso luminoso	Temperatura colore	Numero dei LED	Cavo	Dimensioni
0218/10	€ 14,00	230 V, 50 Hz, 10 W	800 lm	4000 K	15 SMD LED	30 cm, H05RN-F 3x1.0 mm ² mm	150 x 95 mm
0218/20	€ 20,50	230 V, 50 Hz, 20 W	1600 lm	4000 K	28 SMD LED	30 cm, H05RN-F 3x1.0 mm ² mm	145 x 120 mm
0218/30	€ 33,40	230 V, 50 Hz, 30 W	2400 lm	4000 K	42 SMD LED	30 cm, H05RN-F 3x1.0 mm ² mm	180 x 150 mm
0218/50	€ 47,40	230 V, 50 Hz, 50 W	4000 lm	4000 K	56 SMD LED	30 cm, H05RN-F 3x1.0 mm ² mm	210 x 180 mm

0218-XB**FARETTO LED E SUPPORTO**

Alloggiamento pressofuso in alluminio super slim, vetro temperato



Scatola

Alu

Alluminio



IP65



Art.	€	Alimentazione	Flusso luminoso	Temperatura colore	Cavo
0218/10B	€ 31,40	230 V, 50 Hz, 10 W	800 lm	4000 K	2 m, 3x1 mm ² H05VV-F
0218/20B	€ 37,60	230 V, 50 Hz, 20 W	1600 lm	4000 K	2 m, 3x1 mm ² H05VV-F
0218/30B	€ 49,20	230 V, 50 Hz, 30 W	2400 lm	4000 K	2 m, 3x1 mm ² H05VV-F
0218/50B	€ 64,40	230 V, 50 Hz, 50 W	4000 lm	4000 K	2 m, 3x1 mm ² H05VV-F

0218-XS**FARETTO LED CON SENSORE DI MOVIMENTO E LUMINOSITÀ**

Alloggiamento pressofuso in alluminio super slim, vetro temperato



Scatola

Alu

Alluminio



Art.	€	Alimentazione	Flusso luminoso	Temperatura colore	Cavo
0218/10S	€ 27,20	230 V, 50 Hz, 10 W	800 lm	4000 K	30 cm, 3x1 mm ² H05VV-F
0218/20S	€ 32,40	230 V, 50 Hz, 20 W	1600 lm	4000 K	30 cm, 3x1 mm ² H05VV-F
0218/30S	€ 42,90	230 V, 50 Hz, 30 W	2400 lm	4000 K	30 cm, 3x1 mm ² H05VV-F
0218/50S	€ 58,10	230 V, 50 Hz, 50 W	4000 lm	4000 K	30 cm, 3x1 mm ² H05VV-F

0218/50T

€ 93,10

FARETTO LED 50W E TREPPIEDE

Alloggiamento pressofuso in alluminio super slim, vetro temperato



Alimentazione	220 - 240 V, 50 Hz, 50W
Flusso luminoso	4000 lm
Temperatura colore	4000 K
Cavo	2 m, 3x1 mm ² H05VV-F

0713/15

€ 66,70

FARO A LED CON BASE MAGNETICA

Da applicare sul tetto o sul cofano delle auto, dei camper, dei fuoristrada, delle barche, delle macchine agricole e delle macchine movimento terra, con fusibile da 3 a e spina per accendisigari, fascio di luce ampio



Alimentazione	DC 9 ÷ 32 V (12 V, 24 V) 15 W
Numero dei LED	5 x 3 W
Flusso luminoso	1050 lm
Temperatura colore	6000 K
Distanza di illuminazione	5 m - 23 lux; 8,5 m - 10 lux m
Lunghezza cavo	2 m
Dimensione faro	108 x 108 mm
Dimensioni base	Ø 86,50 mm
Interasse dei fori posteriori	87 x 28 mm M6 mm
Dimensioni ingombro	108 x 86,50 x 160 mm

0713/18

€ 75,40

FARO A LED CON BASE MAGNETICA

Da 12V e 24V 18w , da applicare sul tetto o sul cofano delle auto, dei camper, dei fuoristrada, delle barche, delle macchine agricole e delle macchine movimento terra, con fusibile 3 a e spina per accendisigari, fascio di luce medio.



Alimentazione	DC 9 ÷ 32 V (12 V, 24 V) 18 W
Numero dei LED	6 x 3 W
Flusso luminoso	1260 lm
Temperatura colore	6000 K
Distanza di illuminazione	5 m - 45 lux; 12 m - 10 lux m
Lunghezza cavo	2 m
Dimensione faro	Ø 116 mm
Dimensioni base	Ø 86,50 mm
Interasse dei fori posteriori	87 x 28 mm M6 mm
Dimensioni ingombro	116 x 86,50 x 165 mm

0713/27

€ 116,00

FARO A LED CON BASE MAGNETICA

Da 12V e 24V 27w , da applicare sul tetto o sul cofano delle auto, dei camper, dei fuoristrada, delle barche, delle macchine agricole e delle macchine movimento terra, con fusibile 3 a e spina per accendisigari, fascio di luce profondo.



Alimentazione	DC 9 ÷ 32 V (12 V, 24 V) 27 W
Numero dei LED	9 x 3 W
Flusso luminoso	1890 lm
Temperatura colore	6000 K
Distanza di illuminazione	5 m - 85 lux; 15,5 m - 10 lux m
Lunghezza cavo	2 m
Dimensione faro	Ø 116 mm
Dimensioni base	Ø 86,50 mm
Interasse dei fori posteriori	87 x 28 mm M6 mm
Dimensioni ingombro	116 x 86,50 x 165 mm

0343

€ 26,20

LAMPADA SNODATA



Alimentazione	110 / 230 V 50 / 60 Hz
Lampadina	Max 40 W, E27 - non inclusa
Raggio d'azione	800 mm
Capacità morsetto	35 mm

0366

€ 116,00

LAMPADA A 56 LED

Con lente



Alimentazione	230 V 50 Hz 8 W
Ingrandimenti	2x
Flusso luminoso	600 lm
Temperatura colore	6500 K
Lente	Ø 120 mm
Raggio d'azione	810 mm
Capacità morsetto	70 mm

**0530****€ 119,00****LAMPADA A BASSO CONSUMO ENERGETICO**

Con lente



Scatola

Alimentazione	230 V 50 Hz 22 W
Ingrandimenti	3x
Lente	Ø 120 mm
Raggio d'azione	810 mm
Capacità morsetto	70 mm
Flusso luminoso	1000lm

0516**€ 164,00****LAMPADA A BASSO CONSUMO ENERGETICO**

Con lente



Scatola

Alimentazione	230V 50Hz 2 x 9W
Ingrandimenti	2x
Lente	190 x 157 mm
Raggio d'azione	810 mm
Capacità morsetto	70 mm
Flusso luminoso	1000 lm

0344**€ 33,80****LAMPADA SNODATA**

Con lente. Lampadina non inclusa



Scatola

Alimentazione	230 V 50/60 Hz
Lampadina	Max 60 W, E27 - non inclusa
Ingrandimenti	2x
Lente	Ø 100 mm
Raggio d'azione	800 mm
Capacità morsetto	35 mm

0661**€ 50,80****LAMPADA DA TAVOLO**

Con lente



Scatola

Alimentazione	230 V 50 Hz 11 W
Ingrandimenti	2x
Lente	Ø 89 mm



0625 € 33,10

SET LENTI A VISIERA



Scatola

Multiplicatore	Distanza del fuoco mm
1,2x	520 ÷ 620
1,8x	230 ÷ 320
2,5x	150 ÷ 250
3,5x	80 ÷ 120
Lampadina	2,2 V - 0,25 A
Batteria	2 AAA

0659 € 38,60

SERIE DI LENTI IN CRISTALLO



12 Pcs Espositore

Contenuto	Ingrandimenti
3 Pz Ø 50	3x - 10x mm
3 Pz Ø 60	3x - 8x mm
3 Pz Ø 75	3x - 8x mm
3 Pz Ø 90	3x - 8x mm

0659-

LENTE IN CRISTALLO



Scatola

Art.	€	Ø	Ingrandimenti	Pack
0659/50	€ 4,19	50 mm	3x - 10x	10
0659/60	€ 5,50	60 mm	3x - 8x	10
0659/75	€ 6,90	75 mm	3x - 8x	10
0659/90	€ 11,50	90 mm	3x - 8x	10

L006 € 10,30

LENTE IN CRISTALLO CON LED



Scatola

Lente	50 x 50 mm
Ingrandimenti	3x
LED	5 - 9000 mcd
LED	1
Batteria	4 Ag10
Pack	10

0437 € 24,60

FARETTO A LED AD ALTA POTENZA

A lunga autonomia, distanza di illuminazione più di 150m.



Scatola

Batterie non incluse	4 C
Potenza LED	3 W
Autonomia	25 h / 100 %

0482/3 **PRO** € 56,50

LAMPADA DA TESTA CON SENSORE

Funzione di accensione e spegnimento passando con la mano davanti alla lampada.



Scatola

LED	3 W COB
Flusso luminoso	Max 300 lm
Temperatura colore	6500 K
Batteria	3.7 V 1500 mAh Li-ion
Autonomia	4h
Tempo di ricarica	3h

0493/1 € 9,20

LUCE A LED DA CASCO

80lm, in ABS e rivestimento in gomma, con fascia elastica regolabile, 2 funzionalità: luce fissa e lampeggiante, da utilizzare con 3 batterie di tipo AAA.



Scatola

Batterie non incluse	3 x AAA
Luminosità	80 lm
Misure	Ø 50 x 42 x 58 mm
Autonomia	10 h

0493/2 € 23,70

LUCE A LED DA CASCO

120lm, con fascia elastica regolabile, 2 funzionalità: luce fissa e lampeggiante, da utilizzare con 3 batterie di tipo AAA.



Scatola

Batterie non incluse	3 x AAA
Luminosità	120 lm
Misure	Ø 75 x 45 x 45 mm
Autonomia	5 h

**0209****€ 37,60****LAMPADA MAGNETICA
INCLINABILE CON 10 + 1 LED**

Con testa rotante, Led in sommità e 10 Led frontali con 2 livelli di luminosità.



Alu



Blister Alluminio



Flusso luminoso	50 - 300 lm
Temperatura colore	6500 K
Batterie non incluse	3 AAA
Testa inclinabile	180°
Rotazione	180°
Dimensioni	35 x 330 mm

0128A**NEW € 7,80****TORCIA TASCABILE MAGNETICA COB LED + 1 LED**

Con clip magnetico e girevole. Le piccole dimensioni e la grande luminosità la rendono indispensabile sia nel professionale che nel fai da te

ABS

Misure	174 x 43 x 22 mm
Flusso luminoso	140 lm
Batterie non incluse	3 AAA

0671/1P**€ 7,00****TORCIA CON LED A LUCE BIANCA AD ALTA LUMINOSITÀ**

Alu



Alluminio Blister

Batterie non incluse	2 AAA
Numero dei LED	1 - 9000 mcd
Misure	Ø 12,5 x 141 mm

0492**€ 11,80****TORCIA A LED CON MAGNETE TELESCOPICO**

Alu

Espositore Alluminio

Batteria a bottone	4-LR44	Misure	Ø 30 x 21 x 180 mm
Numero dei LED	6	Lunghezza massima	710 mm
Luminosità	6 x 10 lm	Autonomia	3 h

0397**€ 6,90****TORCIA TASCABILE A 7 LED**

Con clip magnetico e girevole, con elevata autonomia, di piccole dimensioni e grande luminosità la rendono indispensabile sia nel professionale che nel fai da te

**ABS**

Espositore



Batterie non incluse	3 AAA
Misure	33 x 16 x 160 mm

0671/8**€ 13,90****TORCIA CON LED A LUCE BIANCA AD ALTA LUMINOSITÀ**

Alu

Blister Alluminio

Batterie non incluse	2 AA
Numero dei LED	8 - 9000 mcd
Misure	Ø 25 x 20 x 140 mm

0787**€ 21,10****TORCIA IN ALLUMINIO**

Alu

Blister Alluminio

Batterie non incluse	2 C
Numero dei LED	8 LED 11000 mcd
Misure	Ø 48,5 x 31 x 215 mm

0107**€ 7,90****LAMPADA MAGNETICA CON 30 + 7 LED**

Con magnete e gancio nella parte posteriore.

**ABS**

Espositore



Vita per singolo LED	100000 ore
Luminosità	50 lm
Batterie non incluse	3 AA
Dimensioni	40 x 35 x 203 mm

0311 € 11,20

LAMPADA MAGNETICA CON 24 LED

Con magnete e gancio nella parte posteriore.



Vita per singolo LED	100000 ore
Batterie non incluse	3 AA

0291 € 9,20

LAMPADA MAGNETICA CON 24 + 3 LED

Con magnete e gancio nella parte posteriore.



Vita per singolo LED	100000 ore
Batterie non incluse	3 AAA

0338 € 41,90

TORCIA IN ALLUMINIO CON 1 LED E FUNZIONE ZOOM MANUALE

3 tipi di luce: forte, media e lampeggiante; adattatore per funzionamento con 3 batterie di tipo AAA e scatola



Batteria	1 lithium (ricaricabile), 3 AAA
LED	Q3 3 W
Misure	Ø 34,5 x 28 x 135 mm
Carica batteria	110 / 230 V 50 / 60 Hz
Autonomia	4 h

0597 € 29,10

LAMPADA A LED RICARICABILE

Con caricabatteria 12VDC e 230VAC, pieghevole, appendibile e magnetica.



Batteria	3.7V 1800 mAh
LED	8 SMD + 5 LED
Tempo di ricarica	8 ÷ 10 h
Autonomia	7 ÷ 8 h

0889 € 60,10

LAMPADA A LED RICARICABILE MAGNETICA

Con caricabatteria 12VDC e 230VAC, pieghevole, appendibile e magnetica.



Batteria	3,7V - 1100 mAh - Li-ion
LED	21 + 5 - 9000 mcd
Tempo di ricarica	4 + 5 h
Autonomia	4 ÷ 6 h

0693A **PRO NEW** € 84,00

LAMPADA A LED RICARICABILE

Con postazione caricabatteria, pieghevole, appendibile e magnetica



Batteria	3,7V - 2600mAh - Li-ion
LED	6W COB LED - 1W SMD 6500K
Flusso luminoso	600 lm
Tempo di ricarica	4h
Autonomia	4.5h Eco mode
Temperatura di esercizio	-10°C+ 40°C

**0401****PRO** € 73,10**LAMPADA RICARICABILE CON TECNOLOGIA LED COB**

Dorso magnetico per l'uso senza l'aiuto delle mani, appoggio flessibile e magnetico. Luce potente da 180 lumen.

**ABS**

Scatola

Alimentazione	100 ÷ 240 V, 50 ÷ 60 Hz
Batteria	3,7 V - 2600 mAh - Li-ion
Tempo di ricarica	6 h
Autonomia	3,5 h
Luminosità	180 lm

**0123**

€ 61,60

FARO MULTIFUNZIONE A LED RICARICABILE CON USB

Dotato di torcia Led anteriore con vari livelli di luminosità, Led bianchi e rossi laterali con funzione lampeggio. Cavo di ricarica usb e trasformatore. Led di stato di carica e ricarica. Possibile ricarica direttamente dal computer.

**ABS**

Scatola

Batteria	3.7V - 1800 mAh - Li-ion
LED	24 Cree XPG R5
Luminosità	30 - 300 lm
Dimensioni	191 x 99 x 148 mm
Carica batteria	USB 110 - 230 V 50 - 60 Hz
Autonomia	2.5 h

**L008****PRO** € 127,00**LAMPADA LED RICARICABILE ULTRA SOTTILE**

Batterie al litio ad alta capacità per lunga autonomia, luce potente da 400 lumen, il design sottile e la struttura robusta la rendono indistruttibile anche se cade da un metro di altezza o, se dimenticata su di un pavimento piano, l'auto ci passa sopra

**ABS**

Scatola



Alimentazione	100 ÷ 240 V, 50 ÷ 60 Hz
Batteria	3,7 V 2400 mAh Lithium
Flusso luminoso	400 lm
Tempo di ricarica	3,5 h
Autonomia	3 - 10 h
Luminosità	400 lm

**G900****NEW** € 14,60**TORCIA DA CAMPEGGIO****ABS**

Scatola

Dimensioni	Ø 60 x 160 mm
Luminosità	150 lm
Batterie non incluse	3 x AAA

**0445/20**

€ 156,00

FARETTO A LED RICARICABILE

Con interruttore, ricarica auto con spina per accendisigari e alimentatore 230V da casa, robusto supporto orientabile.

**Alu**

Scatola

Alluminio

**IP65**

Alimentazione	DC 12 - 24 V, 20 W; AC 230 V 20W
Flusso luminoso	600 - 1450 lm
Batteria	7.4V 5400mAh Li-ion
Autonomia	1,5 h



0429 € 25,60

PORTALAMPADA CON CAVO DI ALIMENTAZIONE DI 5M

Senza interruttore, massimo 60W per lampadine ad incandescenza, attacco lampadina E27 possibilità di funzione da 12V a 230V con lampadina dello stesso voltaggio; lampadina non inclusa.



Appendibile

Lunghezza cavo	5 m
Attacco lampadina	E27
Voltaggio	230 V

0342 € 16,70

LAMPADA AL NEON APPENDIBILE



Blister



Alimentazione	230 V 50 Hz 8 W
Dimensioni	Ø 31 x 435 mm
Cavo	5 m

0900 **PRO NEW** € 84,00

LAMPADA LED CON BASE MAGNETICA

Lampada COB Led portatile in ABS antiurto. Regolabile su quattro diverse intensità di luce da 350 a 1400 Lumen. La forte base magnetica e il corpo ruotabile di 180° la rendono adatta ad essere usata in ogni circostanza.

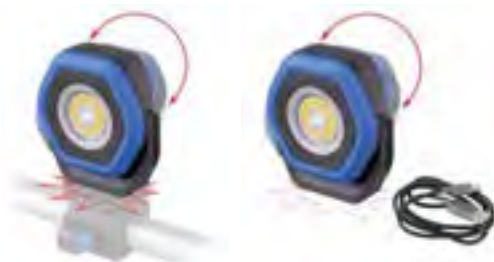

Scatola

Alu

Alluminio

LED	COB
Alimentazione	USB Tipo C 5 V 2 A
Batteria	3.7 V 5200 mAh Li-ion
Flusso luminoso	350 ÷ 1400 lm
Tempo di ricarica	4 h
Autonomia	3 h ÷ 14 h
Dimensioni	116 x 101 x 41.5 mm



0900/BL **PRO NEW** € 235,00

LAMPADA LED SOTTOCOFANO ESTENSIBILE MAGNETICA

Lampada sottocofano con due punti luce COB Led magnetici e ruotabili di 360°, per un massimo di 2800 Lumen (1400lm + 1400lm). La barra è comodamente estensibile fino a 2100mm per potersi agganciare a qualsiasi tipologia di cofano.



Scatola

ABS

Alu

Alluminio

Nylon

LED	COB
Alimentazione	USB Tipo C 5 V 2 A
Batteria	3.7 V 5200 mAh Li-ion
Flusso luminoso	2 x 400-1400 lm
Tempo di ricarica	4 h
Autonomia	4 h
Regolazione ganci a molla	850 ÷ 2100mm

0840 € 119,00

LAMPADA A LED RICARICABILE MAGNETICA CON GANCI ESTENSIBILI

In ABS e policarbonato, 2 funzioni: 18 Led smd - 36 Led smd, con batteria al litio, ricarica auto con spina per accendisigari e alimentatore 230V da casa, indicatore stato della carica.



Scatola

ABS



Alimentazione	DC 12 V 7,2 W; AC 230V
Dimensioni lampada	Ø 38 x 1080 mm
Regolazione ganci a molla	1210 ÷ 1950 mm
Batteria	7.4 V, 1800 mAh Lithium
Luminosità	900 lm, 36 SMD
Tempo di ricarica	4 - 5 h
Autonomia	3h



0621/A3

€ 107,00

AVVOLGICAVO AUTO RIENTRANTE



Scatola

Lunghezza cavo	10 m
Tipo cavo	3 x 1,50 mm ² H05VV-F
Alimentazione	12 V ÷ 240 V
Massima potenza collegabile al cavo avvolto	1200 W
Massima potenza collegabile al cavo svolto	1800 W

A010-X

AVVOLGICAVO

Cavo doppio isolamento H05VV-F omologato spina pressofusa in PVC omologata con spinotti protetti, disgiuntore termico a ripristino manuale, max potenza prelevabile con cavo avvolto 1,2kw, max potenza prelevabile con cavo svolto 3,4kw.



Scatola

Art.	€	Lunghezza cavo	Sezione	Tamburo
A010/10	€ 39,40	10 m	3 x 1,5 mm ²	Ø 200 mm
A010/20	€ 64,00	20 m	3 x 1,5 mm ²	Ø 250 mm

A010/20G

€ 59,20

AVVOLGICAVO DA GIARDINO

Da 20m, costruiti in riferimento alle norme EN 61242, cavo doppio isolamento H05VV-F omologato, spina e presa schuko omologata, disgiuntore termico a ripristino manuale, max potenza prelevabile con cavo avvolto 1,2kw, max potenza prelevabile con cavo svolto 3,4kw.



Scatola

Lunghezza cavo	20 m
Sezione	3 x 1 mm ²
Tamburo	Ø 250 mm

A010/30T

PRO € 371,00

AVVOLGICAVO INDUSTRIALE

Costruiti in riferimento alle norme EN 61316, cavo flessibile H07RN-F omologato in neoprene, prese IP 44/disgiuntore termico a ripristino manuale, max. Potenza prelevabile con cavo avvolto 5kw, max. Potenza prelevabile con cavo svolto 11kw.



Scatola

Alimentazione	380 V
Lunghezza cavo	30 m
Sezione	4 x 2,5 mm ²
Tamburo	Ø 340 mm

0428

€ 113,00

AVVOLGICAVO AUTO RIENTRANTE CON PORTALAMPADA

Protezione contro i sovraccarichi, massimo 60W per lampadine ad incandescenza, Led sull'avvolgicavo che segnala se collegato alla rete elettrica, lampadina non inclusa.



Scatola



Dimensioni cavo	13 + 1 m - H05RR-F - 2 x 1mm ²
Attacco lampadina	E27
Voltaggio	12 ÷ 230 V

A010-

AVVOLGICAVO

Costruiti in riferimento alle norme EN 61242, cavo doppio isolamento H05VV-F omologato spina pressofusa in PVC omologata con spinotti protetti, disgiuntore termico a ripristino manuale, max potenza prelevabile con cavo avvolto 1,2kw, max potenza prelevabile con cavo svolto 3,4kw.



Scatola

Art.	€	Lunghezza cavo	Sezione	Tamburo
A010/15	€ 57,30	15 m	3 x 1,5 mm ²	Ø 190 mm
A010/25	€ 82,90	25 m	3 x 1,5 mm ²	Ø 240 mm
A010/50	€ 148,00	50 m	3 x 1,5 mm ²	Ø 310 mm

A010/30

PRO € 270,00

AVVOLGICAVO INDUSTRIALE

Costruito in riferimento alle norme EN 61316, cavo flessibile H07RN-F omologato in neoprene, prese IP 44/disgiuntore termico a ripristino manuale max. potenza prelevabile con cavo avvolto 5kw, max. potenza prelevabile con cavo svolto 11kw.



Scatola

Alimentazione	230 V
Lunghezza cavo	30 m
Sezione	3 x 2,5 mm ²
Tamburo	Ø 340 mm

0651/6S

€ 12,30

MULTIPRESA CON 6 PRESE BIPASSO + SCHUKO, E SPINA TEDESCA

Con protezione sovratensione



Sezione cavo	3 x 1 mm ²
Lunghezza cavo	1,5 m

OX05C PRO € 63,80
SOLUZIONE OSSIDANTE CONCENTRATA CON SALI DI ARGENTO

Soluzione ossidante concentrata a base di acqua ossigenata stabilizzata con sali d'argento.
Acqua ossigenata, concentrazione 47.5 - 50%



Capacità 5 kg

OX20C PRO € 202,00
SOLUZIONE OSSIDANTE CONCENTRATA CON SALI DI ARGENTO

Soluzione ossidante concentrata a base di acqua ossigenata stabilizzata con sali d'argento.
Acqua ossigenata, concentrazione 47.5 - 50%.



Capacità 20 kg

OX090S PRO € 13,80
SOLUZIONE OSSIDANTE CON SALI DI ARGENTO PRONTA ALL'USO

Prodotto ossidante a base di acqua ossigenata stabilizzata con sali d'argento. L'azione sinergica di questi due principi attivi consente una igienizzazione profonda delle superfici da trattare: il perossido di idrogeno agisce liberando ossigeno attivo al contatto con le superfici trattate, assolvendo il ruolo di detergente igienizzante, i sali di argento potenziano l'effetto purificante.



Capacità 900 ml
Pack 12

OX090 PRO € 10,90
SOLUZIONE OSSIDANTE CON SALI DI ARGENTO PRONTA ALL'USO

Prodotto ossidante a base di acqua ossigenata stabilizzata con sali d'argento. L'azione sinergica di questi due principi attivi consente una igienizzazione profonda delle superfici da trattare: il perossido di idrogeno agisce liberando ossigeno attivo al contatto con le superfici trattate, assolvendo il ruolo di detergente igienizzante, i sali di argento potenziano l'effetto purificante.



Capacità 900 ml
Pack 12

CP05 PRO € 28,70
DETERGENTE ED IGIENIZZANTE PER FILTRI E PACCHI LAMELLARI

Prodotto liquido concentrato contenente agenti bagnanti e tensioattivi non ionici. Viene impiegato per rimuovere facilmente i residui di sporco e grasso che si depositano sui pacchi lamellari delle batterie alettate dei termoconvettori e sui filtri.



Capacità 5 kg

CP090S PRO € 13,30
DETERGENTE ED IGIENIZZANTE PER FILTRI E PACCHI LAMELLARI

Prodotto liquido concentrato contenente agenti bagnanti e tensioattivi non ionici. Viene impiegato per rimuovere facilmente i residui di sporco e grasso che si depositano sui pacchi lamellari delle batterie alettate dei termoconvettori e sui filtri.



Capacità 900 ml
Pack 12

HC001 PRO € 16,00
SALVIETTE DETERGENTI SGRASSANTI

Salviette umidificate leggermente abrasive con azione detergente, igienizzante e sgrassante, ideali per la pulizia delle mani. Si utilizzano senz'acqua e rappresentano la soluzione ottimale per tutti coloro che necessitano di pulire ed igienizzare le mani in qualsiasi situazione e luogo. Elimina i cattivi odori lasciando le mani delicatamente profumate. Non necessita di risciacquo con acqua.



Dimensioni 200 x 160 mm
Pack 6



GL642-

GUANTO IN FIORE BOVINO

Con polso orlato, elastico stringipolso interno



Art.	€	Taglia	Pack
GL642/07	€ 5,90	7	12
GL642/08	€ 5,90	8	12
GL642/09	€ 5,90	9	12
GL642/10	€ 5,90	10	12
GL642/11	€ 5,90	11	12

GL814-

GUANTO IN FIORE BOVINO/CROSTA

Qualità extra, con pollice ad ala, palmo e indice in fiore, dorso in crosta. con polso orlato, elastico stringipolso interno



Art.	€	Taglia	Pack
GL814/07	€ 4,77	7	12
GL814/08	€ 4,77	8	12
GL814/09	€ 4,77	9	12
GL814/10	€ 4,77	10	12
GL814/11	€ 4,77	11	12

GL349-

GUANTO IN TESSUTO JERSEY DI COTONE IMPREGNATO IN NBR

Palmo, dita e nocche ricoperte, leggero, buona resistenza all'abrasione, polso elasticizzato e dorso parzialmente aerato



Art.	€	Taglia	Pack
GL349/07	€ 2,03	7	12
GL349/08	€ 2,03	8	12
GL349/09	€ 2,03	9	12
GL349/10	€ 2,03	10	12
GL349/11	€ 2,03	11	12

GL650-

GUANTO IN FIORE OVINO/COTONE

Palmo in fiore ovino, dorso in maglia di cotone elasticizzato, polso elasticizzato regolabile con velcro



Art.	€	Taglia	Pack
GL650/08	€ 6,70	8 - Blu	12
GL650/09	€ 6,70	9 - Giallo	12
GL650/10	€ 6,70	10 - Rosso	12
GL650/11	€ 6,70	11 - Nero	12

GL345-

GUANTO IN TESSUTO JERSEY DI COTONE IMPREGNATO IN NBR

Palmo, dita e nocche ricoperte, ottima resistenza all'abrasione, idrocarburi e derivati, oli e grassi, manichetta di sicurezza in tela di cotone



Art.	€	Taglia	Pack
GL345/09	€ 3,13	9	12
GL345/10	€ 3,13	10	12

GL347-

NEW

GUANTO IN TESSUTO JERSEY DI COTONE IMPREGNATO IN NBR

Interamente ricoperto, ottima resistenza all'abrasione, idrocarburi e derivati, oli e grassi, manichetta di sicurezza in tela di cotone



Art.	€	Taglia	Pack
GL347/10	€ 3,24	10	12
GL347/11	€ 3,24	11	12

GL373-

GUANTO A FILO CONTINUO 100% POLIESTERE/NITRILE

Palmo ricoperto in nitrile per una valida protezione in presenza di liquidi, oli e/o grassi, ottima resistenza all'abrasione, forma ergonomica, assenza di cuciture, ottimo comfort di calzata, polso elasticizzato e dorso aerato



Art.	€	Taglia	Pack
GL373/07	€ 1,66	7	12
GL373/08	€ 1,66	8	12
GL373/09	€ 1,66	9	12
GL373/10	€ 1,66	10	12

GL365-

GUANTO A FILO CONTINUO 100% POLIESTERE/NITRILE

Palmo ricoperto in nitrile per una valida protezione in presenza di liquidi, oli e/o grassi, ottima resistenza all'abrasione, forma ergonomica, assenza di cuciture, ottimo comfort di calzata, polso elasticizzato



Art.	€	Taglia	Pack
GL365/08	€ 3,39	8	12
GL365/09	€ 3,39	9	12
GL365/10	€ 3,39	10	12

GL722-

GUANTO A FILO CONTINUO 100% NYLON/POLIURETANO

Palmo ricoperto in una speciale miscela di poliuretano ultraleggero, super leggero, super elastico, dall'eccellente sensibilità tattile e destrezza, ottima presa sia su superfici asciutte che umide, con trattamento antibatterico sanitized®, forma ergonomica, assenza di cuciture, ottimo comfort di calzata, polso elasticizzato e dorso aerato



Art.	€	Taglia	Pack
GL722/07	€ 4,79	7	12
GL722/08	€ 4,79	8	12
GL722/09	€ 4,79	9	12
GL722/10	€ 4,79	10	12

GL764-

GUANTO A FILO CONTINUO IN 100% POLIESTERE/POLIURETANO

Palmo ricoperto in poliuretano, massima destrezza e sensibilità tattile, leggero, flessibile, confortevole, con una buona resistenza all'abrasione e all'uso, forma ergonomica, assenza di cuciture, ottimo comfort di calzata, polso elasticizzato e dorso areato



Art.	€	Taglia	Pack
GL764/07	€ 1,66	7	12
GL764/08	€ 1,66	8	12
GL764/09	€ 1,66	9	12
GL764/10	€ 1,66	10	12

GL762-

GUANTO A FILO CONTINUO IN 100% NYLON/POLIURETANO

Palmo ricoperto in poliuretano, leggero, elastico, dall'eccellente sensibilità tattile, consigliato per operazioni delicate e di precisione, ottima resistenza all'abrasione e durata, forma ergonomica, assenza di cuciture, ottimo comfort di calzata, polso elasticizzato e dorso areato



Art.	€	Taglia	Pack
GL762/M	€ 3,13	M	12
GL762/L	€ 3,13	L	12
GL762/XL	€ 3,13	XL	12
GL762/XXL	€ 3,13	XXL	12

GL516-

GUANTO A FILO CONTINUO 100% NYLON/LATTICE

Palmo ricoperto in lattice, finitura increspata per una presa perfetta sia su superfici asciutte che bagnate, forma ergonomica, assenza di cuciture, ottimo comfort di calzata, polso elasticizzato e dorso areato



Art.	€	Taglia	Pack
GL516/08	€ 6,10	8	12
GL516/09	€ 6,10	9	12
GL516/10	€ 6,10	10	12



GL398-

GUANTO A FILO CONTINUO CALIBRO 15 NYLON-ELASTAN/NITRILE SCHIUMATO

Palmo ricoperto in nitrile schiumato, antipelucchi, palmo puntinato per una miglior presa, ottima resistenza all'abrasione e al contempo notevole flessibilità e destrezza, forma ergonomica, assenza di cuciture, ottimo comfort di calzata, polso elasticizzato e dorso aerato



Art.	€	Taglia	Pack
GL398/07	€ 5,50	7	12
GL398/08	€ 5,50	8	12
GL398/09	€ 5,50	9	12
GL398/10	€ 5,50	10	12

GL396-

GUANTO A FILO CONTINUO CALIBRO 15 NYLON-ELASTAN/NITRILE SCHIUMATO

Palmo ricoperto in nitrile schiumato con tecnologia nft™, per una presa eccezionale e antiscivolo, anche in presenza di liquidi e/o oli e per un'umentata resistenza all'abrasione, con trattamento antibatterico sanitized ©, flessibili, dalla massima destrezza, forma ergonomica, assenza di cuciture, ottimo comfort di calzata, polso elasticizzato e dorso aerato



Art.	€	Taglia	Pack
GL396/07	€ 5,70	7	12
GL396/08	€ 5,70	8	12
GL396/09	€ 5,70	9	12
GL396/10	€ 5,70	10	12

GL503-

GUANTO A FILO CONTINUO 100% NYLON/LATTICE

Palmo ricoperto da una speciale e soffice schiuma di lattice, finitura increspata per una presa perfetta sia su superfici asciutte che bagnate, il supporto in colore fluo rende il guanto maggiormente visibile per utilizzo in condizioni di penombra o scarsa visibilità, straordinaria flessibilità, elevata resistenza all'usura e sensibilità tattile, polso elasticizzato e dorso aerato



Art.	€	Taglia	Pack
GL503/08	€ 4,94	8	12
GL503/09	€ 4,94	9	12
GL503/10	€ 4,94	10	12

GL711-

NEW

GUANTO A FILO CONTINUO CALIBRO 15 IN FILATO TECNICO HI-TECH + LYCRA® / POLIURETANO

Il nuovo filato anti taglio hi-tech non utilizza fibre di vetro o acciaio per aumentare le prestazioni, evitando possibili allergie da contatto. Palmo ricoperto in poliuretano per una presa sicura, flessibile, leggero, fresco e traspirante per un comfort ai massimi livelli. Forma ergonomica, assenza di cuciture, riduce l'affaticamento della mano, polso elasticizzato e dorso aerato



Art.	€	Taglia	Pack
GL711/08	€ 4,96	8	12
GL711/09	€ 4,96	9	12
GL711/10	€ 4,96	10	12

GL386-

GUANTO A FILO CONTINUO CALIBRO 13 IN POLIESTERE/NITRILE

Palmo ricoperto in nitrile con finitura leggermente rugosa generata dalla lavorazione del supporto, ottima presa, elevata flessibilità e destrezza, ottima resistenza all'abrasione, forma ergonomica, assenza di cuciture, ottimo comfort di calzata, polso elasticizzato e dorso aerato



Art.	€	Taglia	Pack
GL386/08	€ 2,32	8	12
GL386/09	€ 2,32	9	12
GL386/10	€ 2,32	10	12



EW210 € 4,43

OCCHIALE A STANGHETTA IN POLICARBONATO

EN 166 monolente con protezioni laterali. Può essere indossato sopra occhiali da vista.



Classe ottica	1
Pack	12

EW154 € 3,27

OCCHIALE A MASCHERINA

EN 166 monolente in plastica trasparente, valvole di aerazione fascia elastica.



Plastic

Classe ottica	1
Pack	20

EW213 € 7,50

OCCHIALE A STANGHETTA

EN 166 montatura in policarbonato, lenti con trattamento antigraffio e antiappannante, struttura panoramica avvolgente, stanghette regolabili in lunghezza.



Classe ottica	1
Pack	12

EW249 **NEW** € 16,80

OCCHIALE A STANGHETTA

EN 166 montatura in policarbonato con protezione interna morbida, lenti con trattamento antigraffio e antiappannante, struttura panoramica avvolgente, protezioni laterali. Stanghette regolabili in inclinazione



Classe ottica	1
---------------	---

EW152 € 3,13

OCCHIALE A MASCHERINA

EN 166 monolente in plastica trasparente, fori di aerazione laterali, fascia elastica.



Plastic

Classe ottica	1
Pack	20

EW207 € 7,20

OCCHIALE A STANGHETTA

EN 166 montatura in policarbonato, lenti con trattamento antigraffio e antiappannante, struttura panoramica avvolgente, protezioni laterali.



Classe ottica	1
Pack	12

EW205 **NEW** € 10,50

OCCHIALE A STANGHETTA

EN 166 montatura in policarbonato, lenti con trattamento antigraffio e antiappannante, struttura panoramica avvolgente, protezioni laterali. Insetti in gomma siliconica.



Classe ottica	1
---------------	---

EW257 **NEW** € 13,50

OCCHIALE A STANGHETTA

EN 166 montatura in policarbonato, lenti con trattamento antigraffio e antiappannante, struttura panoramica avvolgente, protezioni laterali. Stanghette regolabili in inclinazione con inserti colorati antiscivolo. Nasello e protezione frontale in morbida gomma antiscivolo.



Classe ottica	1
---------------	---



FP120

€ 8,70

ELMETTO IN POLITENE

EN 397 bardatura in plastica regolabile a 6 punti, isolamento elettrico fino a 440V, fascia antisudore.



FP190

€ 45,30

CINTURA DI POSIZIONAMENTO SUL LAVORO

EN 358 2 anelli di attacco laterali, fibbia di regolazione, schienale anatomico imbottito.



FP194

€ 30,40

CORDINO DI SICUREZZA REGOLABILE

EN 354 & EN 358 fune di sicurezza "Kernmantel" in poliammide, con fibbia di regolazione, connettore in acciaio zincato (ø 18mm) con chiusura di sicurezza.

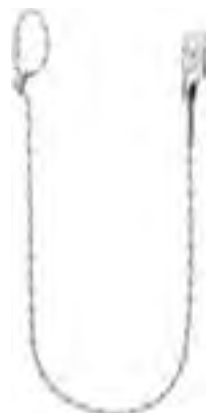

FP166

€ 10,60

CONNETTORE A CHIUSURA AUTOMATICA

EN 362 - Classe B



Diametro cavo ø 12 mm
Lunghessa Max 2 m (inclusi i connettori)



Apertura 18 mm
Resistenza statica del moschettone > 25 kN

FP144

€ 67,50

CORDINO ANTICADUTA CON ASSORBITORE DI ENERGIA

EN 355 fune di sicurezza "kernmantel", connettori non forniti.



Diametro cavo ø 10,5 mm
Lunghessa Max 2 m (inclusi i connettori)

FP192

€ 38,70

IMBRACATURA ANTICADUTA

EN 361 con punto di attacco dorsale e sternale, fibbie di regolazione cosciali, fascia di connessione apribile e regolabile al petto.



0148/72
€ 31,80
PRODOTTI DI PRIMO SOCCORSO

Conformi all'allegato 2 per aziende fino a 2 persone, in valigia di polipropilene con viti di fissaggio a muro

ACCESSORI INCLUSI

- Contenuto conforme all' All. 2 - D.M. 388/03:
- 2 paia guanti sterili monouso
- 125 ml di soluzione cutanea di iodopovidone al 10% di iodio
- 250 ml di soluzione fisiologica (sodio cloruro - 0,9%)
- 3 compresse di garza sterile 10 x 20 cm
- 1 compressa di garza sterile 18 x 40 cm
- 1 confezione cotone idrofilo
- 1 laccio emostatico in lattice
- 1 pinzetta monouso sterile
- 1 confezione cerotti varie misure pz. 10
- 1 rotolo di cerotto alto cm. 2,5 x 5 m
- 1 bende di garza cm 10
- 1 paio di forbici
- 1 ghiaccio pronto uso
- 1 sacchetto monouso per la raccolta di rifiuti sanitari
- 1 manualetto di pronto soccorso multilingue



Dimensioni valigia 309 x 209 x 97 mm

0148/73
€ 118,00
PRODOTTI DI PRIMO SOCCORSO

Conformi all'allegato 1 per aziende con piu' di 2 persone, in valigia di polipropilene con viti di fissaggio a muro

ACCESSORI INCLUSI

- Contenuto conforme all' All. 1 D.M. 388/03:
- 5 guanti sterili monouso
- 1 visiera paraschizzi
- 1000 ml di soluzione cutanea di iodopovidone al 10% di iodio
- 1500 ml di soluzione fisiologica (sodio cloruro - 0,9%)
- 10 compresse di garza sterile 10 x 20 cm
- 2 compresse di garza sterile 18 x 40 cm
- 2 teli sterili monouso cm 40 x 60
- 1 confezione di rete elastica di misura media
- 1 confezione cotone idrofilo
- 3 laccio emostatico in lattice
- 2 pinzetta monouso sterile
- 2 confezioni cerotti varie misure
- 2 rotoli di cerotto alto cm. 2,5 x 5 m
- 1 paio di forbici
- 2 ghiaccio pronto uso
- 2 sacchetti monouso per la raccolta di rifiuti sanitari
- 1 termometro digitale
- 1 manualetto di pronto soccorso multilingue



Dimensioni valigia 405 x 300 x 114 mm

0148/64
€ 21,00
PRODOTTI DI PRIMO SOCCORSO

Borsa in nylon per automezzi e aziende fino a 2 persone, con maniglia e tracolla, chiusura con cerniera.

ACCESSORI INCLUSI

- Contenuto conforme all' All. 2 - D.M. 388/03:
- 2 paia guanti sterili monouso
- 125 ml di soluzione cutanea di iodopovidone al 10% di iodio
- 250 ml di soluzione fisiologica (sodio cloruro - 0,9%)
- 3 compresse di garza sterile 10 x 20 cm
- 1 compressa di garza sterile 18 x 40 cm
- 1 confezione cotone idrofilo
- 1 laccio emostatico in lattice
- 1 pinzetta monouso sterile
- 1 confezione cerotti varie misure pz. 10
- 1 rotolo di cerotto alto cm. 2,5 x 5 m
- 1 bende di garza cm 10
- 1 paio di forbici
- 1 ghiaccio pronto uso
- 1 sacchetto monouso per la raccolta di rifiuti sanitari
- 1 manualetto di pronto soccorso multilingue



Dimensioni valigia 250 x 180 x 90 mm



HP207 € 24,90

CUFFIE ANTIRUMORE AD ARCHETTO

EN 352-1 bardatura temporale, archetto con morbida imbottitura per un miglior comfort, regolazione dell'altezza continua, rapida e stabile, coppe in ABS pieghevoli con morbidi cuscinetti imbottiti, può essere combinata con elmetti, visiere e maschere.



Scatola

SNR

32

HP205 € 12,40

CUFFIE ANTIRUMORE AD ARCHETTO

EN 352-1 archetto in ABS ruotabile in tre posizioni: sopra o dietro il capo, sotto il mento, morbidi cuscinetti in spugna + PVC, facili da pulire, regolazione dell'altezza a scatto, può essere combinata con elmetti, visiere e maschere.



Append.

SNR

27



HP603 € 3,83

INSERTI AURICOLARI CON ARCHETTO

EN 352-2 archetto in polietilene, inserti in schiuma di poliuretano molto soffici che si appoggiano sull'apertura del canale auricolare senza entrare all'interno.



SNR

20

Pack

40

HP601 € 53,30

INSERTI AURICOLARI MONOUSO IN SCHIUMA DI POLIURETANO

EN 352-2 morbidi, di forma anatomica, superficie liscia che ne aumenta l'igiene, 1 paio per bustina.



200 Pcs

SNR

37



RP120 € 1,54

MASCHERINA IN TESSUTO NON TESSUTO

EN 149: 2001 + A1: 2009 protezione da aerosol solidi o liquidi senza tossicità specifica in concentrazione fino a 4x limite di esposizione, morbida guarnizione di tenuta in corrispondenza del naso.



Caratteristiche	FFP1 NR D
Pack	20

RP123 € 1,49

MASCHERINA IN TESSUTO NON TESSUTO

EN 149: 2001 + A1: 2009 protezione da aerosol solidi o liquidi senza tossicità specifica e a bassa tossicità, in concentrazione fino a 12x limite di esposizione.



Caratteristiche	FFP2 NR D
Pack	20

RP124 € 2,58

MASCHERINA IN TESSUTO NON TESSUTO

EN 149: 2001 + A1: 2009 con valvola di espirazione, protezione da aerosol solidi o liquidi senza tossicità specifica e a bassa tossicità, in concentrazione fino a 12x limite di esposizione.



Caratteristiche	FFP2 NR D
Pack	10

RP127 € 4,42

MASCHERINA IN TESSUTO NON TESSUTO CON CARBONI ATTIVI

EN 149: 2001 + A1: 2009 protezione da aerosol solidi o liquidi senza tossicità specifica e a bassa tossicità, in concentrazione fino a 12x limite di esposizione, con innovativa valvola di espirazione newtec®, con carboni attivi che trattengono gli odori forti e sgradevoli impedendone l'inalazione, morbido ponte nasale.



Caratteristiche	FFP2 NR D
Pack	10

RP133 € 3,57

MASCHERINA PIEGHEVOLE IN TESSUTO NON TESSUTO

EN 149: 2001 + A1: 2009 protezione da aerosol solidi o liquidi senza tossicità specifica, a bassa tossicità e ad alta tossicità, in concentrazione fino a 50x limite di esposizione, con innovativa valvola di espirazione newtec®, morbido ponte nasale, confezionata singolarmente.



Caratteristiche	FFP3 NR D
Pack	20

RP126 € 6,30

MASCHERINA IN TESSUTO NON TESSUTO

EN 149: 2001 + A1: 2009 protezione da aerosol solidi o liquidi senza tossicità specifica, a bassa tossicità e ad alta tossicità, in concentrazione fino a 50x limite di esposizione, con innovativa valvola di espirazione newtec®, morbido ponte nasale, guarnizione di tenuta lungo tutto il bordo facciale.



Caratteristiche	FFP3 NR D
Pack	5



FW131-

NEW

SCARPA PROTETTIVA BASSA

EN ISO 20345: 2011 Tomaia realizzata in un tessuto tecnico ad altissima traspirabilità e dall'elevata resistenza all'abrasione. Fodera interna air mesh, traspirante, idrofila, anti umidità. Soletta interna preformata rimovibile, traspirante, antistatica, con trattamento antibatterico, inserto shock absorber nel tallone e supporto dell'arco plantare. Suola in poliuretano mono densità, antistatica e altamente resistente allo scivolamento. Puntale in composito. Lamina tessile anti-perforazione.

Art.	€	Caratteristiche	Taglia
FW131/38	€ 103,00	S3 SRC	38
FW131/39	€ 103,00	S3 SRC	39
FW131/40	€ 103,00	S3 SRC	40
FW131/41	€ 103,00	S3 SRC	41
FW131/42	€ 103,00	S3 SRC	42
FW131/43	€ 103,00	S3 SRC	43
FW131/44	€ 103,00	S3 SRC	44
FW131/45	€ 103,00	S3 SRC	45
FW131/46	€ 103,00	S3 SRC	46
FW131/47	€ 103,00	S3 SRC	47



FW542-

NEW

SCARPA PROTETTIVA ALTA

EN ISO 20345: 2011 Tomaia realizzata in un tessuto tecnico ad altissima traspirabilità e dall'elevata resistenza all'abrasione. Fodera interna air mesh, traspirante, idrofila, anti umidità. Soletta interna preformata rimovibile, traspirante, antistatica, con trattamento antibatterico, inserto shock absorber nel tallone e supporto dell'arco plantare. Suola in poliuretano mono densità, antistatica e altamente resistente allo scivolamento. Puntale in composito. Lamina tessile anti-perforazione.

Art.	€	Caratteristiche	Taglia
FW542/38	€ 113,00	S3 SRC	38
FW542/39	€ 113,00	S3 SRC	39
FW542/40	€ 113,00	S3 SRC	40
FW542/41	€ 113,00	S3 SRC	41
FW542/42	€ 113,00	S3 SRC	42
FW542/43	€ 113,00	S3 SRC	43
FW542/44	€ 113,00	S3 SRC	44
FW542/45	€ 113,00	S3 SRC	45
FW542/46	€ 113,00	S3 SRC	46
FW542/47	€ 113,00	S3 SRC	47



FW077-

NEW







SCARPA PROTETTIVA BASSA TIPO SPORTIVO COMPLETAMENTE ANTISTATICA (PROTEZIONE ESD).





EN ISO 20345: 2011 Tomaia in microfibra con rete KPU traspirabile e resistente. Rinforzi in TNT resistente all'usura. Fodera air mesh, traspirante, idrofila, antiumidità. Soletta preformata rimovibile memory, in mescola EVA + gomma, defaticante, antibatterica, traspirante, con supporto dell'arco plantare. Suola in poliuretano bidensità, antiscivolo, antiabrasione, resistente agli oli, con assorbimento di energia nel tallone. Puntale in fibra di vetro. Lamina tessile anti-perforazione.



Art.	€	Caratteristiche	Taglia
FW077/38	€ 101,00	S1P SRC ESD	38
FW077/39	€ 101,00	S1P SRC ESD	39
FW077/40	€ 101,00	S1P SRC ESD	40
FW077/41	€ 101,00	S1P SRC ESD	41
FW077/42	€ 101,00	S1P SRC ESD	42
FW077/43	€ 101,00	S1P SRC ESD	43
FW077/44	€ 101,00	S1P SRC ESD	44
FW077/45	€ 101,00	S1P SRC ESD	45
FW077/46	€ 101,00	S1P SRC ESD	46
FW077/47	€ 101,00	S1P SRC ESD	47

















	CALIBRI, TRUSCHINI E RIGHE
p. 538	 – Calibri digitali
p. 538	 – Calibri con comparatore
p. 539	 – Calibri vernier
p. 540	 – Truschini
p. 544	 – Righe in acciaio e digitali







	COMPARATORI
p. 546	 – Comparatori digitali e analogici
p. 548	 – Misuratori di spessore
p. 549	 – Centratori



	MICROMETRI
p. 550	 – Micrometri per esterni
p. 551	 – Micrometri per interni

	BLOCCHETTI, ANELLI E TAMPONI
p. 552	 – Blocchetti di riscontro
p. 553	 – Anelli e tamponi

	ACCESSORI PER LA MISURAZIONE
p. 555	 – Basi magnetiche e supporti
p. 558	 – Piani di riscontro
p. 558	 – Squadre
p. 560	 – Spessimetri e contafiletti

	FLESSOMETRI, LIVELLE E GONIOMETRI
p. 563	 – Flessometri
p. 564	 – Livelle
p. 566	 – Goniometri

	MISURATORI ANALOGICI E DIGITALI
p. 567	 – Endoscopi e Microscopi
p. 568	 – Pinze amperometriche e multimetri
p. 569	 – Misuratori digitali
p. 573	 – Rifrattometri
p. 574	 – Durometri

	BILANCE E DINAMOMETRI
p. 576	 – Bilance
p. 577	 – Dinamometri

C031/150

PRO € 176,00

CALIBRO ELETTRONICO DIGITALE INOX

A 2 funzioni con schermo grande



Utile	0÷150 mm 0÷6"
Lettura	0,01 mm 0,0005"
Becchi	40 mm
Asta	16 x 3 mm



C035-

PRO NEW

CALIBRO ELETTRONICO DIGITALE INOX

Con scala di misurazione in vetro per una migliore precisione, carcassa e pulsanti in metallo, uscita dati con porta mini USB, rotella di posizionamento rimovibile, becchi di misurazione rettificati e lappati, con vite di bloccaggio.



Art.	€	Utile	Lettura	Precisione	Ripetibilità	Asta	Becchi	Becchi da interni	Batteria	Altezza cifre
C035/150	€ 69,20	0÷150 mm 0÷6"	0,01 mm 0,0005"	0,02 mm	0,01 mm	16 x 3 mm	40 mm	16,5 mm	1 x 3V CR2032	9 mm
C035/200	€ 95,10	0÷200 mm 0÷8"	0,01 mm 0,0005"	0,03 mm	0,01 mm	16 x 3 mm	50 mm	19,5 mm	1 x 3V CR2032	9 mm
C035/300	€ 166,00	0÷300 mm 0÷12"	0,01 mm 0,0005"	0,03 mm	0,01 mm	16 x 3 mm	60 mm	20,5 mm	1 x 3V CR2032	9 mm



C033-

CALIBRO ELETTRONICO DIGITALE INOX

A 3 funzioni con schermo grande



Art.	€	Utile	Lettura	Asta	Becchi
C033/150	€ 61,00	0÷150 mm 0÷6"	0,01 mm 0,0005"	16 x 3,2 mm	40 mm
C033/200	€ 88,80	0÷200 mm 0÷8"	0,01 mm 0,0005"	16 x 3,2 mm	50 mm
C033/300	€ 132,00	0÷300 mm 0÷12"	0,01 mm 0,0005"	16 x 3,2 mm	60 mm



C041/150

€ 34,20

CALIBRO ELETTRONICO DIGITALE MONOBLOCCO INOX

A 3 funzioni con schermo grande



Utile	0÷150 mm 0÷6"
Lettura	0,01 mm 0,0005"
Becchi	40 mm
Asta	16 x 3 mm





C043-

CALIBRO ELETTRONICO DIGITALE INOX

A 4 funzioni con schermo grande, regolazione micrometrica



Art.	€	Utile	Letture	Becchi	Asta
C043/500	€ 325,00	0÷500 mm 0÷20"	0,01 mm 0,0005"	100 mm	25 x 6 mm
C043/1000	€ 650,00	0÷1000 mm 0÷40"	0,01 mm 0,0005"	150 mm	30 x 8 mm

C047-

PRO NEW

CALIBRO ELETTRONICO DIGITALE INOX

Meccanica in acciaio inossidabile temprata, schermo LCD grande di facile lettura, funzione "Absolute", becchi di misurazione rettificati e lappati, con vite di bloccaggio, estremità dei becchi per misurazione di interni, con regolazione micrometrica



Art.	€	Utile	Letture	Precisione	Ripetibilità	Becchi	Becchi da interni	Batteria	Altezza cifre
C047/300	€ 212,00	0÷300 mm 0÷12"	0,01 mm 0,0005"	0,03 mm	0,01 mm	90 mm	Ø 10 mm	2 x 3V CR2032	11 mm
C047/500	€ 358,00	0÷500 mm 0÷20"	0,01 mm 0,0005"	0,05 mm	0,01 mm	150 mm	Ø 20 mm	2 x 3V CR2032	11 mm
C047/1000	€ 795,00	0÷1000 mm 0÷40"	0,01 mm 0,0005"	0,06 mm	0,01 mm	150 mm	Ø 20 mm	2 x 3V CR2032	11 mm

C047-xB

PRO NEW

CALIBRO ELETTRONICO DIGITALE INOX CON BECCHI SUPERIORI DI MISURA

Meccanica in acciaio inossidabile temprata, schermo LCD grande di facile lettura, funzione "Absolute", becchi di misurazione rettificati e lappati, con vite di bloccaggio, estremità dei becchi per misurazione di interni, con regolazione micrometrica



Art.	€	Utile	Letture	Precisione	Ripetibilità	Becchi	Becchi da interni	Becchi superiori da esterno	Batteria	Altezza cifre
C047/300B	€ 240,00	0÷300 mm 0÷12"	0,01 mm 0,0005"	0,03 mm	0,01 mm	90 mm	Ø 10 mm	38 mm	2 x 3V CR2032	11 mm
C047/500B	€ 388,00	0÷500 mm 0÷20"	0,01 mm 0,0005"	0,05 mm	0,01 mm	150 mm	Ø 20 mm	60 mm	2 x 3V CR2032	11 mm
C047/1000B	€ 937,00	0÷1000 mm 0÷40"	0,01 mm 0,0005"	0,06 mm	0,01 mm	150 mm	Ø 20 mm	63 mm	2 x 3V CR2032	11 mm

C005/150

€ 53,70

CALIBRO CON COMPARATORE INOX



Utile	0 ÷ 150 mm
Letture	0,01 mm
Becchi	40 mm
Asta	15,5 x 3 mm

C006-
CALIBRO CON COMPARATORE INOX

Art.	€	Utile	Letture	Becchi	Asta
C006/150	€ 48,10	0 ÷ 150 mm	0,02 mm	40 mm	16 x 3 mm
C006/200	€ 73,30	0 ÷ 200 mm	0,02 mm	50 mm	16 x 3 mm
C006/300	€ 119,00	0 ÷ 300 mm	0,02 mm	60 mm	20 x 4 mm

C018-
PRO
CALIBRO MONOBLOCCO INOX CROMATO OPACO

Art.	€	Utile	Letture	Becchi	Asta
C018/150	€ 36,20	0÷150 mm 0÷6"	1/20 0,05 mm 1/128"	40 mm	16 x 3 mm
C018/200	€ 56,30	0÷200 mm 0÷8"	1/50 0,02 mm 1/1000"	50 mm	16 x 3 mm

C057/150
€ 20,80
CALIBRO SATINATO

Utile	0÷150 mm 0÷6"
Letture	1/20 0,05 mm 1/128"
Becchi	40 mm
Asta	16 x 3 mm

C011-
PRO
CALIBRO MONOBLOCCO INOX CROMATO OPACO

Alta precisione, con rotellina per bloccaggio cursore, campo di misurazione 0 – 200 mm



Art.	€	Utile	Letture	Becchi	Asta
C011/150	€ 39,50	0÷150 mm 0÷6"	1/50 0,02 mm 1/1000"	40 mm	16 x 3 mm
C011/200	€ 65,40	0÷200 mm 0÷8"	1/50 0,02 mm 1/1000"	50 mm	16 x 3 mm



C019/150

€ 16,50

CALIBRO SATINATO



Scatola 862

Utile	0÷150 mm 0÷6"
Lettura	1/20 0,05 mm 1/128"
Becchi	40 mm
Asta	16 x 3 mm



C056/200

€ 28,90

CALIBRO SATINATO



Scatola 862

Utile	0÷200 mm 0÷8"
Lettura	1/50 0,02 mm 1/1000"
Becchi	50 mm
Asta	16,5 x 3,5 mm



C049/300

€ 61,00

CALIBRO SATINATO

Registrazione micrometrica



Scatola 862

Utile	0 ÷ 300 mm
Lettura	1/50 - 0,02 mm
Becchi	60 mm
Asta	20 x 4 mm



C021-

PRO

CALIBRO MONOBLOCCO SATINATO INOX

Registrazione micrometrica



Scatola 862

Art.	€	Utile	Lettura	Becchi	Asta
C021/300	€ 171,00	0÷300 mm 0÷12"	1/50 0,02 mm 1/1000"	100 mm	23 x 6 mm
C021/500	€ 235,00	0÷500 mm 0÷20"	1/50 0,02 mm 1/1000"	150 mm	23 x 6 mm
C021/1000	€ 525,00	0÷1000 mm 0÷40"	1/50 0,02 mm 1/1000"	150 mm	32 x 10 mm



C020-

CALIBRO SATINATO

Registrazione micrometrica



Art.	€	Utile	Letture	Becchi	Asta
C020/500	€ 148,00	0 ÷ 500 mm	1/50 0,02 mm	100 mm	23 x 6 mm
C020/1000	€ 365,00	0 ÷ 1000 mm	1/50 0,02 mm	150 mm	30 x 10 mm
C020/1500	€ 1020,00	0 ÷ 1500 mm	1/50 0,02 mm	225 mm	49 x 14 mm
C020/2000	€ 1650,00	0 ÷ 2000 mm	1/50 0,02 mm	250 mm	50 x 15 mm

C044-

CALIBRO ELETTRONICO DIGITALE INOX DI PROFONDITÀ

A 3 funzioni con schermo grande



Art.	€	Utile	Letture	Base	Asta
C044/200	€ 86,10	0÷200 mm 0÷8"	0,01 mm 0,0005"	100 mm	13 x 3,5 mm
C044/300	€ 148,00	0÷300 mm 0÷12"	0,01 mm 0,0005"	150 mm	15 x 4 mm

C007-

CALIBRO DI PROFONDITÀ SATINATO



Art.	€	Utile	Letture	Base	Asta
C007/200	€ 37,30	0 ÷ 200 mm	1/50 0,02 mm	100 mm	9,6 x 4,5 mm
C007/300	€ 51,20	0 ÷ 300 mm	1/50 0,02 mm	100 mm	12 x 4 mm

C010/200

€ 53,90

CALIBRO PER TRACCIATURA MONOBLOCCO SATINATO

C010/200P € 7,90

SET 2 PUNTE PER CALIBRO C010/200



Utile	0÷200 mm 0÷8"
Letture	1/10 0,1 mm 1/64"
Becchi	10 mm
Asta	16 x 3 mm





CF08

NEW € 8,40

CALIBRO PER MISURA INTERASSE FORI DADI RUOTA

Utile per la misurazione della distanza dei fori di fissaggio del cerchio. Per cerchi con 4, 5, 6 e 8 fori.



Scatola

Utile 4-8 LUG 100 ÷ 210 mm

T092-

TRUSCHINO DIGITALE MULTIFUNZIONE

A 4 funzioni con schermo grande, con punta a tracciare



Scatola

Art.	€	Campo di misura	Letture	Precisione	Peso netto
T092/300	€ 542,00	0÷300 mm 0÷12"	0,01 mm 0,0005"	0,03 mm 0,015"	4 kg
T092/600	€ 901,00	0÷600 mm 0÷24"	0,01 mm 0,0005"	0,05 mm 0,025"	9 kg

T093-

PRO NEW

TRUSCHINO DIGITALE MULTIFUNZIONE

Con tecnologia Bluetooth integrata, colonna di guida in acciaio inossidabile, con manovella per la regolazione rapida, funzione "Absolute", punta di tracciatura in metallo duro, con collegamento dati per comparatori digitali, con collegamento integrato per l'alimentazione elettrica esterna, base di appoggio in ghisa



INOX

Scatola

Art.	€	Campo di misura	Letture	Precisione	Ripetibilità	Asta	Dimensioni base
T093/300	€ 710,00	0÷300 mm 0÷12"	0,01 mm 0,0005"	0,03 mm	0,02 mm	35 x 15 mm	150 x 100 x 50 mm
T093/600	€ 1020,00	0÷600 mm 0÷24"	0,01 mm 0,0005"	0,05 mm	0,02 mm	35 x 15 mm	150 x 100 x 50 mm

T100-

TRUSCHINO IN ACCIAIO CROMATO OPACO

Con punta a tracciare



Scatola

Art.	€	Campo di misura	Letture	Peso netto
T100/300	€ 110,00	0 ÷ 300 mm	0,02 mm	2 kg
T100/500	€ 218,00	0 ÷ 500 mm	0,02 mm	5,5 kg

REAx-FS
RIGHE IN ACCIAIO INOSSIDABILE

Scala fotoincisa per una lettura più chiara; versione flessibile, lettura da sinistra a destra, superficie opaca senza riflessi.



Append.

Art.	€	Lunghezza	Sezione
REA0150/FS	€ 3,10	150 mm	13 x 0.5 mm
REA0300/FS	€ 4,12	300 mm	13 x 0.5 mm
REA0500/FS	€ 7,20	500 mm	18 x 0.5 mm
REA1000/FS	€ 17,30	1000 mm	18 x 0.5 mm

REAx-FD
RIGHE IN ACCIAIO INOSSIDABILE

Scala fotoincisa per una lettura più chiara; versione flessibile, lettura da destra a sinistra, superficie opaca senza riflessi.



Append.

Art.	€	Lunghezza	Sezione
REA0150/FD	€ 3,10	150 mm	13 x 0.5 mm
REA0300/FD	€ 4,12	300 mm	13 x 0.5 mm
REA0500/FD	€ 7,20	500 mm	18 x 0.5 mm
REA1000/FD	€ 17,30	1000 mm	18 x 0.5 mm

REAx-RS
RIGHE IN ACCIAIO INOSSIDABILE

Scala fotoincisa per una lettura più chiara; versione semi rigida, lettura da sinistra a destra, superficie opaca senza riflessi



Append.

Art.	€	Lunghezza	Sezione
REA0300/RS	€ 7,90	300 mm	30 x 1.0 mm
REA0500/RS	€ 16,50	500 mm	30 x 1.0 mm
REA1000/RS	€ 31,50	1000 mm	30 x 1.0 mm
REA2000/RS	€ 58,60	2000 mm	30 x 1.0 mm

REAx-RD
RIGHE IN ACCIAIO INOSSIDABILE

Scala fotoincisa per una lettura più chiara; versione semi rigida, lettura da destra a sinistra, superficie opaca senza riflessi.



Append.

Art.	€	Lunghezza	Sezione
REA0300/RD	€ 7,90	300 mm	30 x 1.0 mm
REA0500/RD	€ 16,50	500 mm	30 x 1.0 mm
REA1000/RD	€ 31,50	1000 mm	30 x 1.0 mm
REA2000/RD	€ 58,60	2000 mm	30 x 1.0 mm

REAx-RS-MID
RIGHE IN ACCIAIO INOSSIDABILE MID

Scala fotoincisa per una lettura più chiara; versione semi rigida, lettura da sinistra a destra, superficie opaca senza riflessi, tolleranza EC II MID.



Append.

Art.	€	Lunghezza	Sezione
REA0500/RS/MID	€ 19,40	500 mm	30 x 1.0 mm
REA1000/RS/MID	€ 37,80	1000 mm	30 x 1.0 mm
REA2000/RS/MID	€ 75,50	2000 mm	30 x 1.0 mm





REAx-RD-MID

RIGHE IN ACCIAIO INOSSIDABILE MID

Scala fotoincisa per una lettura più chiara; versione semi rigida, lettura da destra a sinistra, superficie opaca senza riflessi, tolleranza EC II MID.



Append.

Art.	€	Lunghezza	Sezione
REA0500/RD/MID	€ 19,40	500 mm	30 x 1.0 mm
REA1000/RD/MID	€ 37,80	1000 mm	30 x 1.0 mm
REA2000/RD/MID	€ 75,50	2000 mm	30 x 1.0 mm



RLAx-RS-MID

RIGHE IN ACCIAIO INOSSIDABILE MID

Scala incisa laser per una maggiore durabilità; versione semi rigida, lettura da sinistra a destra, superficie opaca senza riflessi, tolleranza EC II MID.



Append.

Art.	€	Lunghezza	Sezione
RLA0500/RS/MID	€ 50,60	500 mm	30 x 1.0 mm
RLA1000/RS/MID	€ 99,00	1000 mm	30 x 1.0 mm
RLA2000/RS/MID	€ 199,00	2000 mm	30 x 1.0 mm



RLAx-RD-MID

RIGHE IN ACCIAIO INOSSIDABILE MID

Scala incisa laser per una lettura più chiara; versione semi rigida, lettura da destra a sinistra, superficie opaca senza riflessi, tolleranza EC II MID



Append.

Art.	€	Lunghezza	Sezione
RLA0500/RD/MID	€ 50,60	500 mm	30 x 1.0 mm
RLA1000/RD/MID	€ 99,00	1000 mm	30 x 1.0 mm
RLA2000/RD/MID	€ 199,00	2000 mm	30 x 1.0 mm



REGx-FS

RIGHE IN ACCIAIO INOSSIDABILE CON GANCIO A 90°

Scala incisa per una lettura più chiara; versione flessibile, lettura da sinistra a destra, superficie opaca senza riflessi.



Append.

Art.	€	Lunghezza	Sezione
REG0200/FS	€ 11,90	200 mm	13 x 0.5 mm
REG0300/FS	€ 13,50	300 mm	13 x 0.5 mm
REG0500/FS	€ 26,70	500 mm	18 x 0.5 mm



Rx

RIGA CON DISPLAY DIGITALE MULTIFUNZIONE

La riga può essere tagliata per utilizzare la lunghezza desiderata funzioni: on/off - mm/inch - zero - abs/inc - autospegnimento.



Scatola

Art.	€	Lunghezza totale	Utile	Letture
R060	€ 82,00	630 mm - 24.8" inch	500 mm - 19.7"	0,01 mm 0.001"
R100	€ 107,00	1000 mm - 40" inch	900 mm - 35"	0,01 mm 0.001"



C064 € 105,00

COMPARATORE DIGITALE CENTESIMALE MULTIFUNZIONE

Funzioni principali: azzeramento in ogni posizione, conversione mm/inch memoria e ricerca del valore min/max, spegnimento automatico.



Scatola	878
Campo di misura	0÷12,7 mm 0÷0,5"
Risoluzione	0,01 mm 0,005"
Precisione	0,02 mm 0,002"
Diametro quadrante	60 mm
Batteria	SR44W

C060 **PRO** € 220,00

COMPARATORE DIGITALE MILLESIMALE MULTIFUNZIONE

Funzioni principali: azzeramento in ogni posizione, conversione mm/inch, memoria e ricerca del valore min-max, spegnimento automatico.



Scatola	878
Campo di misura	0÷12,7 mm 0÷0,5"
Risoluzione	0,001 mm 0,0005"
Precisione	0,005 mm 0,0025"
Diametro quadrante	60 mm
Batteria	CR2025

C004 **PRO** € 86,50

COMPARATORE MILLESIMALE



Diametro quadrante	60 mm
Campo di misura	0 ÷ 1 mm
Letture	0,001 mm
Precisione	0,002 mm

C017 **PRO** € 59,90

COMPARATORE CENTESIMALE ANTIURTO

Con movimento su rubini e resistente agli spruzzi d'acqua, con nasello



Diametro quadrante	60 mm
Campo di misura	10 mm
Letture	0,01 mm
Precisione	0,015 mm

C002 € 52,00

COMPARATORE CENTESIMALE



Diametro quadrante	60 mm
Campo di misura	10 mm
Letture	0,01 mm
Precisione	0,015 mm

C023 € 30,50

COMPARATORE CENTESIMALE



Diametro quadrante	60 mm
Campo di misura	10 mm
Letture	0,01 mm
Precisione	0,015 mm

C023G € 20,10

COMPARATORE CENTESIMALE



Diametro quadrante	60 mm
Campo di misura	10 mm
Letture	0,01 mm
Precisione	0,015 mm

C023/N € 34,50

COMPARATORE CENTESIMALE



Diametro quadrante	60 mm
Campo di misura	10 mm
Letture	0,01 mm
Precisione	0,015 mm



C002/42 € 37,50
COMPARATORE CENTESIMALE

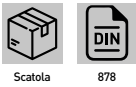

Diametro quadrante	42 mm
Campo di misura	5 mm
Letture	0,01 mm
Precisione	0,015 mm

C048 € 73,40
COMPARATORE CENTESIMALE
Con nasello

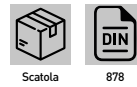

Diametro quadrante	60 mm
Campo di misura	30 mm
Letture	0,01 mm
Precisione	0,015 mm

T003-
INDICATORE A TASTO CENTESIMALE



Art.	€	Diametro quadrante	Campo di misura	Letture	Precisione	Punta tastatrice
T003	€ 92,30	32 mm	0,8 mm	0,01 mm	0,015 mm	Ø 2 mm
T003G	€ 54,80	32 mm	0,8 mm	0,01 mm	0,008 mm	Ø 2 mm

T007-
INDICATORE A TASTO CENTESIMALE



Art.	€	Diametro quadrante	Campo di misura	Letture	Precisione	Punta tastatrice
T007	€ 93,20	40 mm	0,8 mm	0,01 mm	0,011 mm	Ø 2 mm
T007G	€ 59,40	40 mm	0,8 mm	0,01 mm	0,008 mm	Ø 2 mm

T006 € 99,60
INDICATORE A TASTO CENTESIMALE CON TASTATORE LUNGO

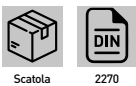

Diametro quadrante	40 mm
Campo di misura	0,8 mm
Letture	0,01 mm
Precisione	0,011 mm
Punta tastatrice	Ø 2 mm
Lunghezza punta tastatrice	29 mm

T005 **PRO** € 110,00
INDICATORE A TASTO BIMILLESIMALE



Diametro quadrante	32 mm
Campo di misura	0,2 mm
Letture	0,002 mm
Precisione	0,005 mm
Punta tastatrice	Ø 2 mm

T011 € 84,40
INDICATORE A TASTO CENTESIMALE

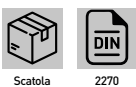

Diametro quadrante	32 mm
Campo di misura	0,8 mm
Letture	0,01 mm
Precisione	0,011 mm
Punta tastatrice	Ø 2 mm

A016-
ALESAMETRO CON COMPARATORE



Scatola

Art.	€	Campo di misura	Letture	Profondità foro
A016/6/10	€ 142,00	6 ÷ 10 mm	0,01 mm	40 mm
A016/10/18	€ 147,00	10 ÷ 18 mm	0,01 mm	100 mm
A016/18/35	€ 147,00	18 ÷ 35 mm	0,01 mm	125 mm
A016/35/50	€ 147,00	35 ÷ 50 mm	0,01 mm	150 mm
A016/50/160	€ 147,00	50 ÷ 160 mm	0,01 mm	150 mm
A016/160/250	€ 164,00	160 ÷ 250 mm	0,01 mm	400 mm
A016/250/450	€ 186,00	250 ÷ 450 mm	0,01 mm	400 mm

M055/120 € 95,90
MISURATORE DI SPESSORI



Scatola

Campo di misura	0 ÷ 10 mm
Letture	0,01 mm
Profondità di misurazione	120 mm

C016 € 157,00
MISURATORE DI PROFONDITÀ



Scatola

Campo di misura	0 ÷ 110 mm
Corsa comparatore	0 ÷ 10 mm
Dimensioni base	63 x 17 mm
Letture	0,01 mm
Prolunghe	10 pz

M062 € 23,80
MISURATORE DI SPESSORI DIGITALE



Scatola

Campo di misura	0 ÷ 12 mm - 0 ÷ 0,5"
Letture	0,01 mm 0,0005"
Profondità di misurazione	20 mm
Precisione	±0,1 mm 0,004"

M055 € 63,00
MISURATORE DI SPESSORI



Scatola

Campo di misura	0 ÷ 10 mm
Letture	0,01 mm
Profondità di misurazione	9 ÷ 16 mm

C014-
MISURATORE RAPIDO PER INTERNI



Scatola

Art.	€	Campo di misura	Bracci	Tastatori	Letture
C014/15/35	€ 142,00	15 ÷ 35 mm	50 mm	Ø 3 x 3 mm	0,01 mm
C014/35/55	€ 142,00	35 ÷ 55 mm	80 mm	Ø 3 x 6 mm	0,01 mm
C014/55/75	€ 142,00	55 ÷ 75 mm	80 mm	Ø 3 x 6 mm	0,01 mm
C014/75/95	€ 142,00	75 ÷ 95 mm	100 mm	Ø 3 x 8 mm	0,01 mm

A020 € 134,00
AZZERZATORE CON COMPARATORE CON BASE MAGNETICA



Scatola

Altezza di azzeramento	50 mm
Letture	0,01 mm
Utile	0 ÷ 8 mm



A021 **PRO NEW** € 124,00

AZZERZATORE CON COMPARATORE CON BASE MAGNETICA

Per posizionare o azzerare l'altezza degli utensili, come frese a candela, direttamente sulle macchine utensili, determinando anche la posizione del mandrino della macchina



Utile	0±2,40 mm 0=0,094"
Letture	0,01 mm 0,0005"
Dimensioni piatto	Ø 24 mm
Altezza cifre	8 mm
Batteria	1 x 3V CR2032
Dimensioni	Ø 50 x 51 mm



C062 € 37,50

CENTRATORE MECCANICO A MOLLA



Gambo	Ø 10 mm
Tastatori	Ø 4 - 10 mm



C063 € 71,90

CENTRATORE LUMINOSO



Gambo	Ø 20 mm
Tastatore	Ø 10 mm
Lunghezza totale	100 mm
Alimentazione	2 x SR44W



C063/L **PRO** € 87,90

CENTRATORE LUMINOSO E SONORO

Con segnale sonoro



Gambo	Ø 20 mm
Tastatore	Ø 10 mm
Lunghezza totale	160 mm
Alimentazione	2 x LR1 1.5V



C061 € 227,00

CENTRATORE A 2 ASSI

Con asta di posizionamento



Comparatore	Ø 40 mm
Corsa	4,9 mm
Letture	0,01 mm
Velocità max di utilizzo	800 rpm
Attacco cilindrico	Ø 10 mm
Tastatori dritti	3
Tastatori curvi	3
Lunghezza tastatori	50 - 100 - 150 mm
Punta tastatrice	Ø 3 mm
Tracciatore snodato	50 mm

M021-

MICROMETRO DIGITALE ELETTRONICO

Con frizione sul tamburo, contatti in metallo duro, funzioni: abs/inc, set, on/off e mm/ inch.



Art.	€	Misura	Lettura	Precisione
M021/00/25	€ 92,30	0 ÷ 25 mm - 0 ÷ 1"	0,001 mm - 0,00005"	0,003 mm - 0,00015"
M021/25/50	€ 115,00	25 ÷ 50 mm - 1" ÷ 2"	0,001 mm - 0,00005"	0,003 mm - 0,00015"
M021/50/75	€ 139,00	50 ÷ 75 mm - 2" ÷ 3"	0,001 mm - 0,00005"	0,004 mm - 0,0002"
M021/75/100	€ 162,00	75 ÷ 100 mm - 3" ÷ 4"	0,001 mm - 0,00005"	0,004 mm - 0,0002"

PRO

M026-

MICROMETRO DIGITALE ELETTRONICO

Con frizione sul tamburo con contatti in metallo duro



Art.	€	Misura	Lettura	Precisione
M026/0/25	€ 179,00	0 ÷ 25 mm - 0 ÷ 1"	0,001 mm 0,0001"	0,0002 mm 0,00008"
M026/25/50	€ 224,00	25 ÷ 50 mm - 1 ÷ 2"	0,001 mm 0,0001"	0,0002 mm 0,00008"
M026/50/75	€ 241,00	50 ÷ 75 mm - 2 ÷ 3"	0,001 mm 0,0001"	0,0003 mm 0,00012"
M026/75/100	€ 267,00	75 ÷ 100 mm - 3 ÷ 4"	0,001 mm 0,0001"	0,0003 mm 0,00012"

M022-

MICROMETRO CENTESIMALE PER ESTERNI

Con tamburo grande a 100 divisioni con contatti in metallo duro e frizione sul tamburo



Art.	€	Misura	Lettura	Precisione
M022/00/25	€ 67,80	0 ÷ 25 mm	0,01 mm	0,004 mm
M022/25/50	€ 84,30	25 ÷ 50 mm	0,01 mm	0,004 mm
M022/50/75	€ 99,20	50 ÷ 75 mm	0,01 mm	0,005 mm
M022/75/100	€ 114,00	75 ÷ 100 mm	0,01 mm	0,005 mm

M033

€ 197,00

ASSORTIMENTO MICROMETRI CENTESIMALI PER ESTERNI

Con contatti in metallo duro e arco verniciato



Misura	0÷25 - 25÷50 - 50÷75 - 75÷100 - 100÷125 - 125÷150 mm
Lettura	0,01 mm
Precisione	0,004 - 0,004 - 0,005 - 0,005 - 0,006 - 0,006 mm
Stelo	∅ 6,3 mm

M033-

MICROMETRO CENTESIMALE PER ESTERNI

Con contatti in metallo duro e arco verniciato



Art.	€	Misura	Lettura	Stelo
M033/00/25	€ 24,80	0÷25 mm	0,01 mm	∅ 6,3 mm
M033/25/50	€ 34,80	25÷50 mm	0,01 mm	∅ 6,3 mm
M033/50/75	€ 38,90	50÷75 mm	0,01 mm	∅ 6,3 mm
M033/75/100	€ 43,10	75÷100 mm	0,01 mm	∅ 6,3 mm

M033-x

MICROMETRO CENTESIMALE PER ESTERNI

Con contatti in metallo duro e arco verniciato



Art.	€	Misura	Lettura	Stelo
M033/100/125	€ 46,10	100÷125 mm	0,01 mm	∅ 6,3 mm
M033/125/150	€ 49,20	125÷150 mm	0,01 mm	∅ 6,3 mm
M033/150/175	€ 58,80	150÷175 mm	0,01 mm	∅ 6,3 mm
M033/175/200	€ 67,00	175÷200 mm	0,01 mm	∅ 6,3 mm
M033/200/225	€ 77,70	200÷225 mm	0,01 mm	∅ 6,3 mm
M033/225/250	€ 94,90	225÷250 mm	0,01 mm	∅ 6,3 mm
M033/250/275	€ 97,70	250÷275 mm	0,01 mm	∅ 6,3 mm
M033/275/300	€ 110,00	275÷300 mm	0,01 mm	∅ 6,3 mm



M009-

MICROMETRO CENTESIMALE PER ESTERNI

Con contatti in metallo duro, arco verniciato



Art.	€	Misura	Letture	Stelo
M009/300/400	€ 338,00	300 ÷ 400 mm	0,01 mm	ø 6,5 mm
M009/400/500	€ 369,00	400 ÷ 500 mm	0,01 mm	ø 6,5 mm
M009/500/600	€ 426,00	500 ÷ 600 mm	0,01 mm	ø 6,5 mm
M009/600/700	€ 507,00	600 ÷ 700 mm	0,01 mm	ø 6,5 mm
M009/700/800	€ 608,00	700 ÷ 800 mm	0,01 mm	ø 6,5 mm
M009/800/900	€ 702,00	800 ÷ 900 mm	0,01 mm	ø 6,5 mm
M009/900/1000	€ 834,00	900 ÷ 1000 mm	0,01 mm	ø 6,5 mm
M009/1000/1200	€ 1230,00	1000 ÷ 1200 mm	0,01 mm	ø 6,5 mm

M010-

MICROMETRO A PIATTELLO

Arco verniciato



Art.	€	Misura	Letture	Piattelli
M010/0/25	€ 106,00	0 ÷ 25 mm	0,01 mm	Ø 20 mm
M010/25/50	€ 130,00	25 ÷ 50 mm	0,01 mm	Ø 20 mm
M010/50/75	€ 137,00	50 ÷ 75 mm	0,01 mm	Ø 20 mm
M010/75/100	€ 144,00	75 ÷ 100 mm	0,01 mm	Ø 20 mm
M010/100/125	€ 184,00	100 ÷ 125 mm	0,01 mm	Ø 27 mm
M010/125/150	€ 209,00	125 ÷ 150 mm	0,01 mm	Ø 27 mm
M010/150/175	€ 232,00	150 ÷ 175 mm	0,01 mm	Ø 27 mm
M010/175/200	€ 245,00	175 ÷ 200 mm	0,01 mm	Ø 27 mm

M019-

MICROMETRO A TRE PUNTE PER INTERNI, PER FORI CIECHI



Art.	€	Anello	Misura	Letture	Precisione
M019/06/08	€ 377,00	1	6 ÷ 8 mm	0,001 mm	0,004 mm
M019/08/10	€ 377,00	1	8 ÷ 10 mm	0,001 mm	0,004 mm
M019/10/12	€ 377,00	1	10 ÷ 12 mm	0,001 mm	0,004 mm
M019/12/16	€ 353,00	1	12 ÷ 16 mm	0,005 mm	0,004 mm
M019/16/20	€ 353,00	1	16 ÷ 20 mm	0,005 mm	0,004 mm
M019/20/25	€ 379,00	1	20 ÷ 25 mm	0,005 mm	0,004 mm
M019/25/30	€ 379,00	1	25 ÷ 30 mm	0,005 mm	0,004 mm
M019/30/40	€ 417,00	1	30 ÷ 40 mm	0,005 mm	0,004 mm
M019/40/50	€ 497,00	1	40 ÷ 50 mm	0,005 mm	0,005 mm
M019/50/63	€ 507,00	1	50 ÷ 63 mm	0,005 mm	0,005 mm
M019/62/75	€ 561,00	1	62 ÷ 75 mm	0,005 mm	0,005 mm
M019/75/88	€ 568,00	1	75 ÷ 88 mm	0,005 mm	0,005 mm
M019/87/100	€ 568,00	1	87 ÷ 100 mm	0,005 mm	0,005 mm
M019/100/125	€ 632,00	0	100 ÷ 125 mm	0,005 mm	0,005 mm
M019/125/150	€ 698,00	0	125 ÷ 150 mm	0,005 mm	0,005 mm

M019-x

ASSORTIMENTO MICROMETRI A TRE PUNTE PER INTERNI, PER FORI CIECHI



Art.	€	Micrometri	Anelli	Misura	Letture	Precisione
M019/06/12	€ 981,00	3	3	6 ÷ 12 mm	0,001 mm	0,004 mm
M019/12/20	€ 535,00	2	1	12 ÷ 20 mm	0,005 mm	0,004 mm
M019/20/40	€ 1040,00	3	2	20 ÷ 40 mm	0,005 mm	0,004 mm
M019/40/100	€ 2290,00	5	3	40 ÷ 100 mm	0,005 mm	0,005 mm

M013/0/100

€ 120,00

MICROMETRO CENTESIMALE DI PROFONDITÀ



Campo di misura	0÷25 mm, 25÷50 mm, 50÷75 mm, 75÷100 mm
Letture	0,01 mm
Base	100 x 17 mm

B0x NEW
SERIE BLOCCHETTI DI RISCONTRO PIANO PARALLELI IN ACCIAIO LAPPATO

Certificato di collaudo emesso dalla fabbrica, certificato Accredia a richiesta



Art.	€	Grado	Pezzi	Misura nominale (mm)	Progressione (mm)	Pz per passo
B008/1	€ 1030,00	1	8	25 - 50 - 75 - 100 - 250 - 300 - 400 - 500	-	1
B011/0	€ 212,00	0	11	2,5 - 5,1 - 7,7 - 10,3 - 12,9 - 15 - 17,6 - 20,2 - 22,8 - 23,4 - 25	-	1
B032/0	€ 429,00	0	32	1,005	-	1
				1,01±1,09	-	9
				1,1±1,9	0,01	9
				1±9	0,1	9
				10 - 20 - 30 - 50	1	4
B032/1	€ 266,00	1	32	1,005	-	1
				1,01±1,09	-	9
				1,1±1,9	0,01	9
				1±9	0,1	9
				10 - 20 - 30 - 50	1	4
B032/2	€ 149,00	2	32	1,005	-	1
				1,01±1,09	-	9
				1,1±1,9	0,01	9
				1±9	0,1	9
				10 - 20 - 30 - 50	1	4
B047/0	€ 610,00	0	47	1,005	-	1
				1,01±1,2	0,01	20
				1,3±1,9	0,1	7
				1±9	1	9
				10±100	10	10
B047/1	€ 361,00	1	47	1,005	-	1
				1,01±1,2	0,01	20
				1,3±1,9	0,1	7
				1±9	1	9
				10±100	10	10
B047/2	€ 214,00	2	47	1,005	-	1
				1,01±1,2	0,01	20
				1,3±1,9	0,1	7
				1±9	1	9
				10±100	10	10
B087/0	€ 1020,00	0	87	1,001±1,009	0,001	9
				1,01±1,49	0,01	49
				0,5±9,5	0,5	19
				10±100	10	10
B087/1	€ 544,00	1	87	1,001±1,009	0,001	9
				1,01±1,49	0,01	49
				0,5±9,5	0,5	19
				10±100	10	10
B087/2	€ 333,00	2	87	1,001±1,009	0,001	9
				1,01±1,49	0,01	49
				0,5±9,5	0,5	19
				10±100	10	10
B103/0	€ 1170,00	0	103	1,005	-	1
				1,01±1,49	0,01	49
				0,5±24,5	0,5	49
				25±100	25	4
B103/1	€ 722,00	1	103	1,005	-	1
				1,01±1,49	0,01	49
				0,5±24,5	0,5	49
				25±100	25	4
B103/2	€ 407,00	2	103	1,005	-	1
				1,01±1,49	0,01	49
				0,5±24,5	0,5	49
				25±100	25	4
B112/0	€ 1020,00	0	112	1,005	-	1
				1,001 ± 1,009	0,001	9
				1,01 ± 1,49	0,01	49
				0,5 ± 24,5	0,5	49
				25 ± 100	25	4
B112/1	€ 721,00	1	112	1,005	-	1
				1,001 ± 1,009	0,001	9
				1,01 ± 1,49	0,01	49
				0,5 ± 24,5	0,5	49
				25 ± 100	25	4

**C025-****CALIBRO TAMPONE LISCIO H7 P/NP TEMPERATO E CEMENTATO**

Art.	€	Ø	Pezzi
C025/03	€ 34,30	3 mm	1
C025/04	€ 34,30	4 mm	1
C025/05	€ 34,30	5 mm	1
C025/06	€ 34,30	6 mm	1
C025/07	€ 34,30	7 mm	1
C025/08	€ 34,30	8 mm	1
C025/09	€ 34,30	9 mm	1
C025/10	€ 34,30	10 mm	1
C025/11	€ 42,50	11 mm	1
C025/12	€ 42,50	12 mm	1
C025/13	€ 42,50	13 mm	1
C025/14	€ 42,50	14 mm	1
C025/15	€ 42,50	15 mm	1
C025/16	€ 42,50	16 mm	1
C025/17	€ 42,50	17 mm	1
C025/18	€ 42,50	18 mm	1
C025/19	€ 42,50	19 mm	1
C025/20	€ 42,50	20 mm	1
C025/21	€ 63,60	21 mm	1
C025/22	€ 63,60	22 mm	1
C025/23	€ 63,60	23 mm	1
C025/24	€ 63,60	24 mm	1
C025/25	€ 63,60	25 mm	1
C025/26	€ 63,60	26 mm	1
C025/27	€ 63,60	27 mm	1
C025/28	€ 63,60	28 mm	1
C025/29	€ 63,60	29 mm	1
C025/30	€ 79,70	30 mm	1
C025/32	€ 79,70	32 mm	1
C025/33	€ 79,70	33 mm	1
C025/34	€ 79,70	34 mm	1
C025/35	€ 79,70	35 mm	1
C025/36	€ 79,70	36 mm	1
C025/37	€ 79,70	37 mm	1
C025/38	€ 79,70	38 mm	1
C025/40	€ 79,70	40 mm	1
C025/42	€ 79,70	42 mm	1
C025/44	€ 79,70	44 mm	1
C025/45	€ 89,60	45 mm	1
C025/46	€ 89,70	46 mm	1
C025/47	€ 89,70	47 mm	1
C025/48	€ 89,70	48 mm	1
C025/50	€ 89,70	50 mm	1
C025/51	€ 96,20	51 mm	1
C025/52	€ 96,20	52 mm	1
C025/55	€ 96,20	55 mm	2
C025/56	€ 96,20	56 mm	2
C025/57	€ 96,20	57 mm	2
C025/58	€ 96,20	58 mm	2
C025/59	€ 96,20	59 mm	2
C025/60	€ 96,20	60 mm	2
C025/62	€ 116,00	62 mm	2
C025/63	€ 116,00	63 mm	2
C025/65	€ 116,00	65 mm	2
C025/66	€ 116,00	66 mm	2
C025/67	€ 116,00	67 mm	2
C025/68	€ 116,00	68 mm	2
C025/69	€ 116,00	69 mm	2
C025/70	€ 154,00	70 mm	2
C025/71	€ 154,00	71 mm	2
C025/72	€ 154,00	72 mm	2
C025/74	€ 154,00	74 mm	2
C025/75	€ 154,00	75 mm	2
C025/76	€ 154,00	76 mm	2
C025/78	€ 154,00	78 mm	2
C025/80	€ 154,00	80 mm	2

C025-3x**SERIE CALIBRI TAMPONE LISCI PASSA NON PASSA H7 TEMPERATI**

Valigetta

Art.	€	Pezzi	Passo	Ø
C025/3/30	€ 1080,00	28	1 mm	3 + 30 mm
C025/32/62	€ 1290,00	16	-	32-35-37-38-40-42-45-47-48-50-52-55-56-58-60-62 mm

A015-**ANELLO DI AZZERAMENTO**

Precisione 6g.



2250

Art.	€	Misura
A015/008	€ 51,90	8 mm
A015/010	€ 58,20	10 mm
A015/011	€ 58,20	11 mm
A015/017	€ 63,60	17 mm
A015/025	€ 63,60	25 mm
A015/035	€ 63,60	35 mm
A015/040	€ 108,00	40 mm
A015/062	€ 120,00	62 mm
A015/087	€ 283,00	87 mm
A015/100	€ 298,00	100 mm
A015/125	€ 461,00	125 mm
A015/150	€ 647,00	150 mm

T048x
TAMPONE FILETTATO DOPPIO P/NP

Passo gas cilindrico



Art.	€	Dimensioni
T0481/8	€ 64,50	1/8" - 28 TPI
T0481/4	€ 64,50	1/4" - 19 TPI
T0483/8	€ 64,50	3/8" - 19 TPI
T0481/2	€ 83,00	1/2" - 14 TPI
T0485/8	€ 96,80	5/8" - 14 TPI
T0483/4	€ 103,00	3/4" - 14 TPI
T0487/8	€ 134,00	7/8" - 14 TPI
T0481	€ 157,00	1" - 11 TPI

A018x
ANELLO FILETTATO TIPO PASSA

Anello filettato tipo passa, passo gas cilindrico



Art.	€	Dimensioni
A0181/8	€ 66,50	1/8" - 28 TPI
A0181/4	€ 66,50	1/4" - 19 TPI
A0183/8	€ 66,50	3/8" - 19 TPI
A0181/2	€ 91,20	1/2" - 14 TPI
A0185/8	€ 91,20	5/8" - 14 TPI
A0183/4	€ 111,00	3/4" - 14 TPI
A0187/8	€ 134,00	7/8" - 14 TPI
A0181	€ 97,70	1" - 11 TPI

T049x
TAMPONE FILETTATO DOPPIO P/NP METRICO 6H

Art.	€	Dimensioni
T0493X0.5	€ 59,10	3 x 0,5 mm
T0494X0.7	€ 76,10	4 x 0,7 mm
T0495X0.8	€ 78,70	5 x 0,8 mm
T0496X1	€ 78,70	6 x 1 mm
T0498X1	€ 71,70	8 x 1 mm
T0498X1.25	€ 71,70	8 x 1,25 mm
T04910X1	€ 73,40	10 x 1 mm
T04910X1.25	€ 73,40	10 x 1,25 mm
T04910X1.5	€ 73,40	10 x 1,5 mm
T04912X1.25	€ 73,40	12 x 1,25 mm
T04912X1.5	€ 73,40	12 x 1,5 mm
T04912X1.75	€ 73,40	12 x 1,75 mm
T04914X1.5	€ 78,70	14 x 1,5 mm
T04914X2	€ 78,70	14 x 2 mm
T04916X1.5	€ 82,20	16 x 1,5 mm
T04916X2	€ 82,20	16 x 2 mm
T04918X1.5	€ 61,00	18 x 1,5 mm
T04918X2.5	€ 61,00	18 x 2,5 mm
T04920X1.5	€ 66,80	20 x 1,5 mm
T04920X2.5	€ 66,80	20 x 2,5 mm
T04922X1.5	€ 68,40	22 x 1,5 mm
T04922X2.5	€ 68,40	22 x 2,5 mm
T04924X1.5	€ 71,70	24 x 1,5 mm
T04924X2	€ 71,70	24 x 2 mm
T04924X3	€ 71,70	24 x 3 mm

A017x
ANELLO FILETTATO 6G TIPO PASSA METRICO

Art.	€	Dimensioni
A0173X0.5	€ 57,30	3 x 0,5 mm
A0174X0.7	€ 64,50	4 x 0,7 mm
A0175X0.8	€ 64,50	5 x 0,8 mm
A0176X1	€ 53,70	6 x 1 mm
A0178X1	€ 53,70	8 x 1 mm
A0178X1.25	€ 53,70	8 x 1,25 mm
A01710X1	€ 76,10	10 x 1 mm
A01710X1.25	€ 59,10	10 x 1,25 mm
A01710X1.5	€ 59,10	10 x 1,5 mm
A01712X1.25	€ 82,20	12 x 1,25 mm
A01712X1.5	€ 82,20	12 x 1,5 mm
A01712X1.75	€ 82,20	12 x 1,75 mm
A01714X2	€ 82,20	14 x 2 mm
A01716X1.5	€ 87,10	16 x 1,5 mm
A01716X2	€ 87,10	16 x 2 mm
A01718X1.5	€ 61,00	18 x 1,5 mm
A01718X2.5	€ 61,00	18 x 2,5 mm
A01720X1.5	€ 64,30	20 x 1,5 mm
A01720X2.5	€ 64,30	20 x 2,5 mm
A01722X1.5	€ 73,30	22 x 1,5 mm
A01722X2.5	€ 73,30	22 x 2,5 mm
A01724X1.5	€ 97,70	24 x 1,5 mm
A01724X2	€ 97,70	24 x 2 mm
A01724X3	€ 97,70	24 x 3 mm

S091
SERIE SPINE CALIBRATE
€ 474,00

Valigetta

Pezzi	91
Misura	1±10 mm
Progressione	0,1 mm
Lunghezza	50 mm
Durezza	HRC-60-62
Precisione	±0,002 mm



**T009**

€ 31,90

SUPPORTO TASTATORE AD ARCO

Valigetta



Attacco maschio	Ø 8 mm
Attacco femmina	Ø 4 mm

B201/2

€ 19,70

BASE MAGNETICA

Per porta comparatore, materiale magnetico n35, selettore in abs e base prismatica



Valigetta



Dimensioni base	60 x 50 x 55 mm
Foro	M8 x 1,25
Forza magnetica	800 N

B201/1

€ 16,60

BASE MAGNETICA

Per porta comparatore, materiale magnetico n35, selettore in abs e base prismatica



Valigetta



Dimensioni base	36 x 30 x 35 mm
Foro	M5 x 0,8
Forza magnetica	300 N

B201/3

€ 26,00

BASE MAGNETICA

Per porta comparatore, materiale magnetico n35, selettore in abs e base prismatica



Valigetta



Dimensioni base	73 x 50 x 55 mm
Foro	M8 x 1,25
Forza magnetica	1000 N

B201/4

€ 36,30

BASE MAGNETICA

Per porta comparatore, materiale magnetico n35, selettore in abs e base prismatica



Valigetta



Dimensioni base	117 x 50 x 55 mm
Foro	M8 x 1,25
Forza magnetica	1300 N

B100

€ 23,70

BASE MAGNETICA

Per porta comparatore, selettore in abs e base prismatica



Valigetta



Dimensioni	63 x 50 x 55h mm
Foro	M8 x 1,25
Forza magnetica	600 N

S052/2

€ 31,20

SUPPORTO MAGNETICO PORTA COMPARATORE

Con regolazione micrometrica, colonna robusta e braccio trasversale regolabile. Base magnetica con appoggio prismatico e commutatore



Valigetta



Asta principale	Ø 12 x 176 mm
Asta secondaria	Ø 10 x 150 mm
Forza magnetica	800 N
Dimensioni base	60 x 50 x 55 mm

S052/3

€ 54,00

SUPPORTO MAGNETICO PORTA COMPARATORE

Con regolazione micrometrica, colonna robusta e braccio trasversale regolabile. Base magnetica con appoggio prismatico e commutatore.



Valigetta



Asta principale	Ø 16 x 225 mm
Asta secondaria	Ø 14 x 165 mm
Forza magnetica	1000 N
Dimensioni base	73 x 50 x 55 mm

S052/4

€ 80,00

**SUPPORTO MAGNETICO PORTA
COMPARATORE**

Con regolazione micrometrica, colonna robusta e braccio trasversale regolabile. base magnetica con appoggio prismatico e commutatore



Valigetta

Asta principale	ø 20 x 355 mm
Asta secondaria	ø 14 x 210 mm
Forza magnetica	1300 N
Dimensioni base	117 x 50 x 55 mm



S049

€ 35,20

**SUPPORTO MAGNETICO PORTA
COMPARATORE**

Con regolazione micrometrica



Valigetta

Asta principale	ø 12 x 170 mm
Asta secondaria	ø 10 x 150 mm
Forza magnetica	600 N
Dimensioni base	63 x 50 x 55h mm



S047

€ 65,90

**SUPPORTO MAGNETICO PORTA
COMPARATORE**

Con regolazione micrometrica



Valigetta

Asta principale	ø 16 x 220 mm
Asta secondaria	ø 12 x 180 mm
Forza magnetica	800 N
Dimensioni base	65 x 50 x 55h mm



S054

€ 31,90

**SUPPORTO MAGNETICO PORTA
COMPARATORE**



Valigetta

Asta principale	ø 12 x 170 mm
Asta secondaria	ø 10 x 165 mm
Forza magnetica	600 N
Dimensioni base	63 x 50 x 55h mm



S055

€ 62,20

**SUPPORTO MAGNETICO PORTA
COMPARATORE**



Valigetta

Asta principale	ø 16 x 210 mm
Asta secondaria	ø 12 x 175 mm
Forza magnetica	800 N
Dimensioni base	75 x 50 x 55h mm



S042/1

€ 57,50

**SUPPORTO ARTICOLATO
MECCANICO**

Con bloccaggio centrale 3d delle aste



Valigetta

Dimensioni base	36 x 30 x 35 mm
Forza magnetica	300 N
Lunghezza braccio	145 mm



S042/2

€ 72,70

**SUPPORTO ARTICOLATO
MECCANICO**

Con microregolazione e bloccaggio centrale 3d delle aste



Valigetta

Dimensioni base	60 x 50 x 55 mm
Forza magnetica	800 N
Lunghezza braccio	290 mm



S042/3

€ 93,50

**SUPPORTO ARTICOLATO
MECCANICO**

Con microregolazione e bloccaggio centrale 3d delle aste



Valigetta

Dimensioni base	75 x 50 x 55 mm
Forza magnetica	1000 N
Lunghezza braccio	365 mm





S045 € 73,80

SUPPORTO ARTICOLATO MECCANICO



Valigetta

Asta principale	Ø 12 x 160 mm
Asta secondaria	Ø 10 x 180 mm
Forza magnetica	600 N
Dimensioni base	63 x 50 x 55h mm

S046 € 113,00

SUPPORTO ARTICOLATO IDRAULICO



Valigetta

Asta principale	Ø 17 x 180 mm
Asta secondaria	Ø 14 x 200 mm
Forza magnetica	600 N
Dimensioni base	63 x 50 x 55h mm

B025 € 218,00

STATIVO PORTA COMPARATORE

Con piano scanalato e base in alluminio.



Valigetta

Porta comparatore	Ø 8 mm
Dimensioni piano	80 x 80 mm
Dimensioni base	150 x 100 mm
Colonna	Ø 25 x 180 mm

B010 € 269,00

STATIVO PORTA COMPARATORE

Con base in granito



Valigetta

Porta comparatore	Ø 8 mm
Dimensioni base	300 x 200 x 50h mm
Colonna	Ø 35 x 300 mm
Planarità base	0,002 mm

A019-

APPARECCHIO A DUE PUNTE PER IL CONTROLLO DELLA CONCENTRICITÀ

Con superfici di scorrimento rettificate e dotato di supporto porta comparatore



Cassa di legno



Ghisa

Art.	€	Distanza tra le punte	Altezza punte Min. - Max	CM	Dimensioni	Porta comparatore	Peso netto
A019/300	€ 1220,00	300 mm	145 / 175 mm	2	730 x 310 x 370h mm	2	65 kg
A019/500	€ 1560,00	500 mm	135 / 170 mm	2	924 x 330 x 482h mm	2	70 kg
A019/1000	€ 1840,00	1000 mm	135 / 170 mm	2	1400 x 330 x 430h mm	2	100 kg

S051 € 31,50

SUPPORTO MICROMETRO

Con ganasce ricoperte di plastica morbida



Scatola



Ghisa

P04x

PIANO DI RISCONTRO IN GRANITO

Grado 0



Cassa di legno

Art.	€	Dimensioni	Peso netto
P040	€ 87,60	310 x 230 x 80 mm	20 kg
P042	€ 281,00	630 x 400 x 100 mm	80 kg
P043	€ 752,00	1000 x 630 x 150 mm	280 kg
P047	€ 1250,00	1200 x 800 x 160 mm	497 kg
P044	€ 2640,00	1600 x 1000 x 200 mm	1059 kg

S06x

SQUADRA DI RISCONTRO IN GRANITO

Grado 0



Cassa di legno



876

Art.	€	Dimensioni	Precisione
S061	€ 417,00	250 x 40 x 400h mm	± 6 µm
S062	€ 589,00	400 x 100 x 635h mm	± 9 µm

B040-

BANCO PER PIANO IN GRANITO CON DUE CASSETTI



Art.	€	Dimensioni base	Dimensioni piano	Peso netto
B040/1	€ 883,00	945 x 590 mm	1000 x 630 mm	63,5 kg
B040/2	€ 986,00	1200 x 750 mm	1200 x 800 - 1600 x 1000 mm	80 kg

S050-

PRO

SQUADRA A 90°

Adatta per il controllo di ortogonalità e planarità nell'industria meccanica di precisione. Con cappello



Acciaio



875/1

Art.	€	Dimensioni	Sezione
S050/150	€ 33,50	150 x 100 mm	25,5 x 4,8 mm ²
S050/200	€ 42,60	200 x 130 mm	30,3 x 6 mm ²
S050/250	€ 56,90	250 x 165 mm	35 x 7 mm ²
S050/300	€ 63,30	300 x 200 mm	36 x 9 mm ²
S050/400	€ 140,00	400 x 265 mm	39 x 9 mm ²
S050/500	€ 168,00	500 x 330 mm	50 x 9 mm ²

S051-

NEW

SQUADRA A 90°

Adatta per il controllo di ortogonalità e planarità nell'industria meccanica. Con cappello



Acciaio



Made in Germany

Art.	€	Dimensioni	Sezione
S051/100	€ 14,30	100 x 70 mm	20 x 5,5 mm ²
S051/150	€ 16,50	150 x 100 mm	20 x 5,5 mm ²
S051/200	€ 22,60	200 x 130 mm	20 x 5,5 mm ²
S051/250	€ 26,10	250 x 160 mm	25 x 5,5 mm ²
S051/300	€ 33,60	300 x 175 mm	25 x 5,5 mm ²
S051/400	€ 37,00	400 x 200 mm	29,5 x 5,5 mm ²
S051/500	€ 56,90	500 x 250 mm	29,5 x 5,5 mm ²
S051/600	€ 71,50	600 x 330 mm	29,5 x 5,5 mm ²
S051/750	€ 169,00	750 x 375 mm	29,5 x 5,5 mm ²
S051/1000	€ 201,00	1000 x 500 mm	29,5 x 5,5 mm ²

S059-

NEW

SQUADRA A 90°

Adatta per il controllo di ortogonalità e planarità nell'industria meccanica. Senza cappello



Acciaio



Made in Germany

Art.	€	Dimensioni	Sezione
S059/100	€ 8,30	100 x 70 mm	20 x 5,5 mm ²
S059/150	€ 9,90	150 x 100 mm	20 x 5,5 mm ²
S059/200	€ 11,60	200 x 130 mm	20 x 5,5 mm ²
S059/250	€ 13,90	250 x 160 mm	25 x 5,5 mm ²
S059/300	€ 15,90	300 x 175 mm	25 x 5,5 mm ²
S059/400	€ 20,20	400 x 200 mm	29,5 x 5,5 mm ²
S059/500	€ 24,10	500 x 250 mm	29,5 x 5,5 mm ²
S059/600	€ 28,90	600 x 330 mm	29,5 x 5,5 mm ²
S059/750	€ 49,60	750 x 375 mm	29,5 x 5,5 mm ²
S059/1000	€ 72,30	1000 x 500 mm	29,5 x 5,5 mm ²



S048-

SQUADRA BISELLATA A 90°



875/00

Art.	€	Dimensioni	Sezione
S048/100	€ 35,60	100 x 70 mm	20 x 5 mm ²
S048/150	€ 54,00	150 x 100 mm	25 x 5 mm ²

0129-

PRO

SQUADRA DA CARPENTIERE

Con lama in alluminio temprata (HRB 70) nera anodizzata con scala antiriflesso incisa laser su ambo i lati e manico allungato in alluminio con profilo scanalato.



Scatola

Alu

Alluminio



Made in Germany

Art.	€	Lunghezza lama	Sezione lama	Lunghezza	
				manico	Sezione manico
0129/150	€ 21,10	150 mm	40 x 2 mm	130 mm	40 x 12 mm
0129/200	€ 21,50	200 mm	40 x 2 mm	130 mm	40 x 12 mm
0129/250	€ 23,00	250 mm	40 x 2 mm	145 mm	40 x 12 mm
0129/300	€ 24,60	300 mm	40 x 2 mm	145 mm	40 x 12 mm
0129/400	€ 29,60	400 mm	40 x 2 mm	170 mm	40 x 12 mm
0129/500	€ 32,30	500 mm	40 x 2 mm	170 mm	40 x 12 mm

0139-

PRO

SQUADRA ANGOLATA

Con lama in alluminio temprata (HRB 70) nera anodizzata con scala antiriflesso incisa laser su ambo i lati e manico allungato in alluminio con profilo scanalato.



Scatola

Alu

Alluminio



Made in Germany

Art.	€	Lunghezza lama	Sezione lama	Sezione manico	Angolo
0139/250	€ 21,90	250 mm	40 x 2 mm	40 x 12 mm	45° / 135°
0139/300	€ 23,10	300 mm	40 x 2 mm	40 x 12 mm	45° / 135°

0286-

SQUADRA FALEGNAME MILLIMETRATA



Art.	€	Dimensioni
0286/250	€ 2,83	250 x 130 x 0,8 mm
0286/300	€ 3,34	300 x 130 x 0,8 mm
0286/350	€ 3,72	350 x 155 x 0,8 mm

0132-

PRO

FALSA SQUADRA

Lama in acciaio al carbonio, manico in alluminio con profilo scanalato e vite di fissaggio galvanizzata.



Scatola



Acciaio



Made in Germany

Art.	€	Lunghezza lama	Sezione lama	Sezione manico
0132/200	€ 20,00	200 mm	29 x 1.6 mm	30 x 11.5 mm
0132/250	€ 21,50	250 mm	29 x 1.6 mm	30 x 11.5 mm
0132/300	€ 23,40	300 mm	29 x 1.6 mm	30 x 11.5 mm

S056-

SQUADRA MAGNETICA A 90°



Scatola

Art.	€	Dimensioni	Forza magnetica max.
S056/150	€ 82,30	150 x 150 x 50 mm	500 N
S056/200	€ 103,00	200 x 200 x 50 mm	1000 N

S058 € 94,80
SQUADRA MAGNETICA INCLINABILE



Scatola

Dimensioni	115 x 115 x 35 mm
Gradi	45° ± 90°
Forza magnetica max.	250 N

S057/125 € 19,10
POSIZIONATORE MAGNETICO



Scatola

Dimensioni	135 x 135 x 25 mm
Forza magnetica	340 N
Angolo di posizionamento	45 - 90 - 135°

S057/060S € 12,90
SERIE POSIZIONATORI MAGNETICI



4 Pcs



Scatola

Dimensioni	50 x 60 x 12,5 mm
Forza magnetica	45 N
Angolo di posizionamento	45 - 90 - 135°

0212 € 8,00
SPESSIMETRO



Blister

Lame num.	20
Misure	0,05 - 1,00 mm

FGx
SET DI SPESSIMETRI

Lame a forma conica, custodia placcata in nichel con dado di bloccaggio, misure in mm e pollici su ogni lama.



Blister



Acciaio

Art.	€	Lame num.	Tolleranza	Misure	Lunghezza lama
FG01	€ 4,42	13	T2	0,05 - 1,00 mm 0,002 - 0,040"	100 mm
FG02	€ 7,50	20	T2	0,05 - 1,00 mm 0,002 - 0,040"	100 mm

FGx-AI
SET DI SPESSIMETRI IN ACCIAIO INOX

Lame a forma conica, custodia placcata in nichel con dado di bloccaggio, misure in mm e pollici su ogni lama.



Blister

INOX

Art.	€	Lame num.	Tolleranza	Misure	Lunghezza lama
FG01/AI	€ 13,10	13	T2	0,05 - 1,00 mm 0,002 - 0,040"	100 mm
FG02/AI	€ 20,90	20	T2	0,05 - 1,00 mm 0,002 - 0,040"	100 mm



TGx-AE

SPESSIMETRO A NASTRO CONTINUO

Misura in mm e pollici su ogni lama. Tolleranza T2



Art.	€	Spessore	Lunghezza
TG001/AE	€ 60,90	0.01 mm 0.0004"	5 m
TG002/AE	€ 47,20	0.02 mm 0.0008"	5 m
TG003/AE	€ 26,00	0.03 mm 0.0012"	5 m
TG004/AE	€ 27,00	0.04 mm 0.0016"	5 m
TG005/AE	€ 18,90	0.05 mm 0.0020"	5 m
TG006/AE	€ 18,90	0.06 mm 0.0024"	5 m
TG007/AE	€ 18,90	0.07 mm 0.0028"	5 m
TG008/AE	€ 18,90	0.08 mm 0.0030"	5 m
TG009/AE	€ 18,90	0.09 mm 0.0035"	5 m
TG010/AE	€ 18,90	0.10 mm 0.0040"	5 m
TG012/AE	€ 18,90	0.12 mm 0.005"	5 m
TG015/AE	€ 17,40	0.15 mm 0.006"	5 m
TG018/AE	€ 18,90	0.18 mm 0.007"	5 m
TG020/AE	€ 17,40	0.20 mm 0.008"	5 m
TG025/AE	€ 17,40	0.25 mm 0.010"	5 m
TG030/AE	€ 17,40	0.30 mm 0.012"	5 m
TG035/AE	€ 18,90	0.35 mm 0.014"	5 m
TG040/AE	€ 18,90	0.40 mm 0.016"	5 m
TG045/AE	€ 18,90	0.45 mm 0.018"	5 m
TG050/AE	€ 18,90	0.50 mm 0.020"	5 m
TG055/AE	€ 27,00	0.55 mm 0.022"	5 m
TG060/AE	€ 27,00	0.60 mm 0.024"	5 m
TG065/AE	€ 27,00	0.65 mm 0.026"	5 m
TG070/AE	€ 23,20	0.70 mm 0.028"	5 m
TG075/AE	€ 23,20	0.75 mm 0.030"	5 m
TG080/AE	€ 23,20	0.80 mm 0.032"	5 m
TG085/AE	€ 23,20	0.85 mm 0.034"	5 m
TG090/AE	€ 23,20	0.90 mm 0.036"	5 m
TG095/AE	€ 23,20	0.95 mm 0.038"	5 m
TG100/AE	€ 23,20	1.00 mm 0.040"	5 m
TG110/AE	€ 17,70	1.10 mm	1 m
TG120/AE	€ 17,70	1.20 mm	1 m
TG130/AE	€ 17,70	1.30 mm	1 m
TG140/AE	€ 17,70	1.40 mm	1 m
TG150/AE	€ 17,70	1.50 mm	1 m
TG160/AE	€ 17,70	1.60 mm	1 m
TG170/AE	€ 17,70	1.70 mm	1 m
TG180/AE	€ 17,70	1.80 mm	1 m
TG190/AE	€ 17,70	1.90 mm	1 m
TG200/AE	€ 17,70	2.00 mm	1 m

C026-

COMPASSO

A punta con gambo quadrato



Art.	€	Lunghezza
C026/150	€ 8,80	150 mm
C026/200	€ 10,90	200 mm
C026/250	€ 14,90	250 mm
C026/300	€ 17,20	300 mm

HT125

€ 7,00

SUPPORTO PER SPESSIMETRO A NASTRO



Blister

Dimensioni 125 x 17 mm



C058/52

NEW € 9,00

CONTAFILETTI A 52 LAME



Blister

Lame metriche 0.25 - 6 mm 60°

Lame a pollici 4 - 62 TPI 55°

C058

€ 12,80

CONTAFILETTI A 58 LAME



Blister

Lame metriche 0.25 - 6 mm 60°

Lame a pollici 4 - 62 TPI 55°

Lame a gas 8 - 28 TPI 55°

C027-

COMPASSO

Con guida e gambo quadrato



Art.	€	Lunghezza
C027/150	€ 12,30	150 mm
C027/200	€ 14,50	200 mm
C027/250	€ 18,00	250 mm
C027/300	€ 20,00	300 mm

C028-

COMPASSO

Per spessori esterni



Art.	€	Lunghezza
C028/150	€ 8,80	150 mm
C028/200	€ 10,90	200 mm
C028/250	€ 12,70	250 mm
C028/300	€ 14,90	300 mm

C029-

COMPASSO

Per interni



Art.	€	Lunghezza
C029/150	€ 8,80	150 mm
C029/200	€ 10,90	200 mm
C029/250	€ 12,70	250 mm
C029/300	€ 14,90	300 mm

P007-

PRISMA MAGNETICO

Singolo od in coppia



Scatola

Art.	€	Dimensioni	Larghezza	Forza magnetica max.	Pezzi
P007/1	€ 112,00	70 x 60 x 72 mm	38 mm	400 N	1
P007/2	€ 144,00	100 x 70 x 95 mm	50 / 16 mm	300 N	1
P007/1C	€ 213,00	71 x 60 x 73 mm	38 mm	400 N	2
P007/2C	€ 328,00	100 x 70 x 95 mm	50 / 16 mm	300 N	2



P30x

PRISMA A 90°

Con morsetto, singolo o in coppia.



Scatola



Acciaio



Temprato

Art.	€	Dimensioni	Bloccaggio massimo	Precisione	Pezzi
P301/2	€ 62,80	63,5 x 63,5 x 50 mm	ø 35 mm	±0,01 mm	1
P302/2	€ 107,00	100 x 75 x 75 mm	ø 65 mm	±0,01 mm	1
P303/2	€ 165,00	150 x 125 x 100 mm	ø 110 mm	±0,01 mm	1
P301/2C	€ 121,00	63,5 x 63,5 x 50,8 mm	ø 35 mm	±0,01 mm	2
P302/2C	€ 210,00	100 x 75 x 75 mm	ø 65 mm	±0,01 mm	2
P303/2C	€ 329,00	150 x 125 x 100 mm	ø 110 mm	±0,01 mm	2



P20x

COPPIA PRISMI RETTIFICATI



Scatola

C45

Art.	€	Dimensioni	Precisione
P200/1	€ 229,00	75 x 75 x 60 mm	1/100 mm
P201/1	€ 304,00	100 x 80 x 60 mm	1/100 mm

P011-

PRISMA INCLINABILE



Scatola

Art.	€	Dimensioni
P011/075	€ 106,00	75 x 32 x 25 mm
P011/100	€ 126,00	102 x 48 x 46 mm



F2Gx

FLESSOMETRO

Con meccanismo di arresto in acciaio, gancio rivettato all'estremità con protezione della lama inferiore mediante ammortizzatore



Espositore

Art.	€	Dimensioni nastro	Classe di precisione
F2G2	€ 3,26	2 m x 16 mm	II
F2G3	€ 3,73	3 m x 16 mm	II
F2G5	€ 5,70	5 m x 19 mm	II

F68x

FLESSOMETRO MAGNETICO

Con meccanismo di arresto in acciaio, gancio rivettato all'estremità con protezione della lama inferiore mediante ammortizzatore



Espositore

Art.	€	Dimensioni nastro	Classe di precisione
F683	€ 6,10	3 m x 19 mm	II
F685	€ 8,50	5 m x 25 mm	II
F688	€ 12,20	8 m x 25 mm	II

F80x

FLESSOMETRO

Di forma ergonomica antiscivolo, con bloccaggio sicuro e preciso, gancio per cintura, nastro di spessore maggiorato con rivestimento in poliestere antiabrasivo



Espositore

Art.	€	Dimensioni nastro	Classe di precisione
F802	€ 2,58	2 m x 16 mm	II
F803	€ 4,19	3 m x 16 mm	II
F805	€ 5,90	5 m x 19 mm	II
F808	€ 8,50	8 m x 25 mm	II

F32x

FLESSOMETRO MAGNETICO

Con freno automatico e magnete



Espositore

Art.	€	Dimensioni nastro	Classe di precisione
F322	€ 4,20	2 m x 16 mm	II
F323	€ 5,60	3 m x 19 mm	II
F325	€ 7,60	5 m x 25 mm	II
F328	€ 10,60	8 m x 25 mm	II

R0x

ROTELLA METRICA

Con nastro in acciaio



Scatola

Art.	€	Dimensioni nastro
R030	€ 25,60	30 m x 13 mm
R050	€ 39,70	50 m x 13 mm

0646/A

LASER AUTOLIVELLANTE

€ 117,00



Scatola

Precisione di livellamento	0,5 mm / m
Precisione linea orizzontale e verticale	± 0,5 mm / m
Batteria	3 x 1,5V AA
Tipo laser	Classe II / 650 nm
Distanza di lavoro consigliata	10 m
H massima	126,5 cm
H minima	52,5 cm

0449

€ 23,30

MINI LIVELLA LASER

A 4 fiale, con corpo in ABS, raggio laser in grado di emettere un unico punto o una croce perpendicolare.



Scatola

Tipo laser	Classe II / 650 nm
Distanza di lavoro	20 m
Potenza	$\leq 1\text{ mW}$
Accuratezza	0,05°
Batteria	2 x 1,5V AAA

0666

€ 176,00

LIVELLA DIGITALE CON RAGGIO LASER

Visualizzazione dell'angolo o della percentuale di inclinazione.



Scatola

Lunghezza	600 mm
Autospegnimento	5 min
Gamma di misurazione	0 ~ 360°
Lunghezza d'onda	650 nm
Risoluzione	0,1°
Potenza laser	$\leq 1\text{ mW}$
Precisione livella	± 0,05°
Precisione del punto	± 1 mm / m
Batteria	9 V

0109

€ 48,00

LIVELLA DIGITALE

Magnetica con corpo in alluminio, autospegnimento, schermo retroilluminato, 2 fiale, lettura assoluta e relativa, funzione "hold"



Scatola

Lunghezza	400 mm
Autospegnimento	5 min
Gamma di misurazione	0 - 90° x 4
Risoluzione	0° - 90°: 0,1°
Precisione livella	0° - 90°: ±0,2°
Batteria	2 x AAA 1,5V

0112

€ 105,00

LIVELLA DIGITALE

Magnetica con corpo in alluminio e base fresata, autospegnimento, schermo retroilluminato, 2 fiale, funzione "hold", ricerca del 0° e 90° sonoro, lettura: assoluta e relativa, gradi, percentuale, mm/m e in/ft, borsa per il trasporto.



Scatola

Lunghezza	600 mm
Autospegnimento	5 min
Gamma di misurazione	0 - 90° x 4
Risoluzione	0° & 90°: 0,05°; 0° - 89°: 0,1°
Precisione livella	0° & 90°: ±0,05°; 0,1° - 89,9°: ±0,2°
Batteria	2 x AAA 1,5 V



L090A € 109,00

LIVELLA DIGITALE INCLINOMETRO E GONIOMETRO CON MAGNETE

Funzioni: 0 ÷ 90° in tutte le 4 direzioni, inclinazione mm/m, inclinazione in/ft, percentuale d'inclinazione %, retroilluminazione, autospegnimento, misurazione assoluta (ABS) e relativa, inversione automatica dei numeri per letture sottosopra, con segnale acustico.



Scatola

Precisione	± 0.15°
Gamma di misurazione	0 ÷ 90° x 4
Risoluzione	0.05°
Dimensioni	151 x 31 x 60 mm
Batteria	2 x 1.5 V AAA

L085 € 83,60

LIVELLA QUADRA DIGITALE

Magnetica in 2 x 0 ÷ 180°, autospegnimento, misurazione assoluta (ABS) e relativa, inversione automatica dei numeri per letture sottosopra e funzione hold.



Blister



Precisione	± 0.1°
Gamma di misurazione	0° ÷ 180°
Risoluzione	0.1°
Dimensioni	51 x 51 x 33 mm
Batteria	1 x 3 V CR2032

0824-

LIVELLA

In alluminio a 3 fiale, fresata e millimetrata



Art.	€	Dimensioni
0824/300	€ 5,60	300 x 49 x 23 mm
0824/400	€ 6,30	400 x 49 x 23 mm
0824/500	€ 7,40	500 x 49 x 23 mm
0824/600	€ 8,40	600 x 49 x 23 mm

L080 € 53,00

LIVELLA QUADRA DIGITALE

Magnetica 0 ÷ 90° in tutte le 4 direzioni, retroilluminazione, autospegnimento, misurazione assoluta (ABS) e relativa, inversione automatica dei numeri per letture sottosopra.



Blister

Precisione	0° ± 0.1°; 90° ± 0.1°; 0.1° ÷ 89.9° ± 0.2°
Gamma di misurazione	0 ÷ 90° x 4
Risoluzione	0.1°
Dimensioni	59 x 27 x 59 mm
Batteria	1 x 1.5 V AAA

0805/400 € 9,10

LIVELLA MAGNETICA

A 3 fiale millimetrata



Dimensioni	400 x 50 x 20 mm
------------	------------------

L200 € 188,00

LIVELLA LINEARE

Rettificata di alta precisione, con base prismatica



Dimensioni	200 x 45 x 45 mm
Precisione	0,02 mm / m

L150 € 218,00

LIVELLA QUADRA

Rettificata di alta precisione, con 2 facce piane e 2 prismatiche



Dimensioni	150 x 38 x 150 mm
Precisione	0,02 mm / m

G006-

GONIOMETRO SEMPLICE

Con vite di bloccaggio, scala incisa al laser

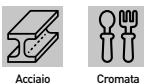

Acciaio Cromata

Art.	€	Arco	Asta	Campo di misura
G006/120	€ 21,00	Ø 80 mm	120 mm	0 ÷ 180°
G006/150	€ 23,50	Ø 120 mm	150 mm	0 ÷ 180°
G006/200	€ 28,50	Ø 150 mm	200 mm	0 ÷ 180°
G006/300	€ 40,00	Ø 200 mm	300 mm	0 ÷ 180°
G006/500	€ 82,50	Ø 300 mm	500 mm	0 ÷ 180°
G006/600	€ 94,00	Ø 300 mm	600 mm	0 ÷ 180°

G005 € 85,30

GONIOMETRO UNIVERSALE



Lettura	5'
Scala	0° ÷ 360°
Asta	300 mm

G008 € 50,90

GONIOMETRO DIGITALE E LIVELLA CON 2 FIALE

Calcolo automatico di angoli e inclinazioni



Lunghezza	400 mm
Scala	0 ÷ 225°
Lettura	0,1°
Accuratezza	± 0,5°
Batteria	9 V - 6F22

G004- **PRO NEW**

GONIOMETRO SEMPLICE

Con vite di bloccaggio, scala incisa al laser



Alluminio

Art.	€	Arco	Asta	Campo di misura	Durezza
G004/120	€ 26,50	Ø 80 mm	120 mm	0 ÷ 180°	HRC 63
G004/150	€ 30,50	Ø 120 mm	150 mm	0 ÷ 180°	HRC 63
G004/200	€ 37,50	Ø 150 mm	200 mm	0 ÷ 180°	HRC 63
G004/300	€ 50,00	Ø 200 mm	300 mm	0 ÷ 180°	HRC 63
G004/500	€ 105,00	Ø 300 mm	500 mm	0 ÷ 180°	HRC 63



E023/5 € 675,00

ENDOSCOPIO FLESSIBILE PER MECCANICA

Con sonda Ø 5,5mm - wi-fi usb dotato di: schermo a colori lcd 3,5" con connessione wi-fi alla sonda - memoria micro sd 2gb con adattatore sd - porta usb - uscita con cavo usb - sonda flessibile - videocamera dotata di luci Led - specchio a 45° - sfera di direzione - ghiera di protezione.



Lunghezza senza manico	1000 mm
Sonda	Ø 5,5 mm
Zoom digitale	4X
Profondità di campo	50 mm
Visione	60°
Batteria ricaricabile	Lithium

E022/5 € 348,00

SONDA FLESSIBILE

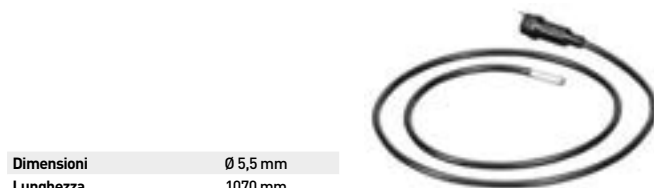

Dimensioni	Ø 5,5 mm
Lunghezza	1070 mm

E022/P € 75,80

PROLUNGA FLESSIBILE



Dimensioni	Ø 18 mm
Lunghezza	2750 mm

M071 € 393,00

MICROSCOPIO STEREOSCOPICO



Luce propria incidente e diretta	12 V - 10 W
Altezza massima del pezzo da controllare	75 mm
Alimentazione	230 V 50 Hz
Oculari	10x
Obiettivi	2x - 4x
Ingrandimenti	20x ÷ 40x

E022/12 € 348,00

ENDOSCOPIO FLESSIBILE PER MECCANICA

Con sonda Ø 12mm dotato di: schermo a colori lcd 3,5" - sonda flessibile - videocamera dotata di luci Led - possono essere aggiunte fino a 2 prolunghere - terminale magnetico - terminale a gancio - terminale con specchio.



Lunghezza senza manico	900 mm
Sonda	Ø 12 mm
Visione	0° - 60°
Batteria	9 V
Massima profondità di rilevazione	50 mm
Distanza	2.5 cm - 30 cm
Display	3.5" LCD
Tempo di utilizzo	> 2hr
Temperatura di esercizio	0°C - 45°C
Temperatura stoccaggio	-20°C - +60°C
Dimensioni	215 x 156 x 96 mm

M069 € 556,00

MICROSCOPIO STEREOSCOPICO



Luce propria diretta	12 V - 10 W
Distanza di lavoro	165 mm 10x - 119 mm 20x
Alimentazione	230 V 50 Hz
Oculari	10x - 20x
Obiettivi	1x - 2x
Ingrandimenti	10x ÷ 40x

M072 € 28,70

LENTE DI PRECISIONE PER MISURAZIONI



Ingrandimenti	10x
Campo di vista	24 mm
Campo di misura	0 ÷ 20 mm
Letture	0,1 mm

P080 € 78,70

PINZA AMPEROMETRICA DIGITALE

Con display LCD. 7 modalità di funzionamento: corrente AC, voltaggio AC, voltaggio in DC, resistenza, continuità, frequenza, controllo diodo. Alta affidabilità



Scatola

ACV	4 / 40 / 400 / 600 V ±1,5% + 4
ACA	4 / 40 / 400 / 600 A ±1,5% + 4
DCV	4 / 40 / 400 / 600 V ±1,0% + 2
RES	400 Ω / 4 kΩ / 40 kΩ / 400 kΩ / 4 MΩ / 40 MΩ ±1,0% + 2
Frequenza	10 MHz ±0,8% + 2
Batteria	2 x 1,5 V x AA
Temperatura stoccaggio	-20°C - 60°C
Temperatura di esercizio	0°C - 50°C
Dimensioni	250 x 71 x 38,8 mm

P075 € 132,00

PINZA AMPEROMETRICA DIGITALE



Scatola

ACV	750 V ±1,2%
ACA	200 - 1000 A ±2,0%
DCV	1000 V ±1,0%
DCA	200 - 1000 A ±2,0%
RES	200 Ω ±1,0%
Frequenza	2k Hz ±2,5%
Batteria	9 V

0013/142 € 1,64

GIRAVITE CERCAFASE

Con impugnatura in materiale isolante, luce al neon e lama in acciaio



Campo di misura	100 ÷ 500 V
Lunghezza	142 mm

0013/185 € 1,79

GIRAVITE CERCAFASE

Con impugnatura in materiale isolante, luce al neon e lama in acciaio



Campo di misura	100 ÷ 500 V
Lunghezza	190 mm

0446 € 14,00

PROVA BATTERIA E CARICA DELL'ALTERNATORE

Di facile uso, con Led di segnalazione stato della batteria e della carica.



Batteria	11,5 ÷ 12,6V
Stato della carica	13,2 ÷ 15,5 V
Lunghezza cavo	800 mm

T051 € 18,80

MULTIMETRO DIGITALE TASCABILE

Continuità sonora e controllo diodi



Scatola

DCV	2-20-200-500V ±0,5%
ACV	200-500V ±1,2%
DCA	200mA ±1,5%
RES	2K-20K-200K-2M Ω ±1%
Batteria	12V

0029 € 5,50

TESTER RUBACORRENTE

Per rilevare la corrente nei cavi delle automobili, con valori di tensione da 6-12-24V.



Voltaggio	6 - 12 - 24 V
-----------	---------------



T050

€ 37,30

MULTIMETRO DIGITALE

Con sonda per misurazione temperatura, continuità sonora e controllo diodi



Scatola

DCV	200 mV ±0,5%
DCV	2 V - 20 V - 200 V ±0,8%
DCV	1000 V ±0,1%
ACV	2mV - 20 V - 200 V ±1,0%
ACV	750 V ±1,2%
DCA	2 mA - 20 mA ±1,8%
DCA	200 mA ±2,0%
DCA	20 A ±2,0%
ACA	200 mA ±2,0%
ACA	20 A ±3,0%
RES	200 Ω ±1,0%
RES	2KΩ - 20KΩ - 200KΩ - 2MΩ ±1,0%
RES	20 MΩ ± 1.0%
RES	200 MΩ ±5,0%
CAP	2000 pF - 20 nF - 200 nF - 2 μF - 20 μF ±4%
Temperatura	-40 °C ÷ 400 °C ±1,0%
Temperatura	400 °C ÷ 1000 °C ±1,5%
Batteria	9 V



T053

PRO € 89,50

MULTIMETRO DIGITALE

Con sonda per misurazione temperatura, continuità sonora e controllo diodi



Scatola

DCV	200 mV - 2 V - 20 V - 200 V - 1000 V ±0,8%
ACV	200 mV - 2 V - 20 V - 750 V ±1,2%
DCA / ACA	200 μA - 2 mA - 20 mA - 200 mA - 20 A ±2,0%
RES	200Ω - 2kΩ - 20kΩ - 200kΩ - 2MΩ - 20MΩ - 200MΩ ±1%
CAP	20 nF / 200 nF / 2 μF / 20 μF / 200 μF / 2000 μF ±2,5%
Induttanza	2 mH - 20mH - 200 mH - 2 H - 20 H
Batteria	9 V
Temperatura	-20 °C ÷ 1000 °C
Frequenza	10 mHz
Test transistor hFE	0 - 1000



ML80A

€ 81,00

MISURATORE DI DISTANZA LASER

Maneggevole e leggero, ideale per misurazioni nell'edilizia e in carpenteria, funzioni: addizioni, sottrazioni, area e volume, autospegnimento



Blister



Campo di misura	0,05 ÷ 80 m
Precisione	±2 mm
Batteria	3 AAA x 1,5 V

ML40

€ 60,20

MISURATORE DI DISTANZA LASER

Maneggevole e leggero, ideale per misurazioni in edilizia e in carpenteria, funzioni: addizioni, sottrazioni, area e volume, autospegnimento



Blister



Campo di misura	0,05 ÷ 40 m
Precisione	± 2 mm
Batteria	2 AAA x 1.5 V

T068

€ 131,00

MISURATORE DI TEMPERATURA AD INFRAROSSI CON PUNTATORE LASER

Non idoneo alla misura della temperatura corporea



Blister

Campo di misura	-30°C÷550 °C -22 F÷1022 F
Precisione	-30 °C ÷ 0 °C -22 F ÷ 32 F ±3 % o ±3 °C
Precisione	0 °C ÷ 100 °C 32 F ÷ 212 F ±2 % o ±2 °C
Precisione	> 100 °C > 212 F ±3 % o ±3 °C
Letture	0,1 °C 0,1 F
Emissività	0,1 ÷ 1,0
Batteria	9 V
Dimensioni	146 x 80 x 38 mm
Distanza / Diametro dell'area	1 : 12

T064

€ 101,00

MISURATORE DI TEMPERATURA AD INFRAROSSI CON PUNTATORE LASER

Alta precisione. Misurazione della temperatura senza contatto. Non idoneo per essere umani



Blister

Campo di misura	-25°C÷400 °C -13 F÷752 F
Precisione	-25 °C ÷ 400 °C ±(2 % + 1 °C)
Precisione	-13 F ÷ 752 F ±(2 % + 1 F)
Letture	1 °C 2 F
Batteria	9 V
Distanza / Diametro dell'area	1 : 10
Tempo di misurazione	0.5 s
Emissività pre- impostata	0.95

T057

€ 224,00

MISURATORE DIGITALE DI TEMPERATURA E UMIDITÀ AMBIENTE

Alta precisione, con micro-computer LSI.



Valigetta

Temperatura	-10 °C ÷ +65 °C
Letture temperatura	0,1 °C
Precisione temperatura	±0,5 °C
Umidità relativa	10 % ÷ 100 %
Precisione	2 % ±1 % RH
Batteria	4 x 1,5 V AA
Tempo di risposta	0.4 s
Consumo di energia	16 mA
Dimensioni	202 x 72 x 37 mm

I002

€ 327,00

IGROMETRO A CONTATTO PER LA MISURAZIONE DI UMIDITÀ

Del legno e materiali da costruzione. Con Micro- Computer LSI e timer a cristalli per alta precisione. Collegamento computer per trasferimento dati. Non idoneo per misurare l'umidità ambientale.



Valigetta

Temperatura di esercizio	0 °C - 40 °C
Campo di misura	0 - 80 %
Materiali da costruzione	0 - 50 %
Letture	0,1 %
Precisione	± (0,5 % n+1)
Batteria	4 x 1,5 V AA
Dimensioni	165 x 62 x 26 mm

T054

€ 37,30

MISURATORE DI TEMPERATURA DIGITALE TASCABILE

Con sonde per rilevare la temperatura o per immersione



Scatola

Letture	1 °C
Campo di misura	-50°C ÷ 1100°C con uso sonda T056/TP03 non in dotazione, -50°C ÷ 750°C con uso sonda T056/TP02 in dotazione, -50°C ÷ 250
Precisione	0°C ÷ 500°C ±(0,75% +1°C), 500°C ÷ 750°C ± (1% + 1°C), 750°C ÷ 1000°C ± (2% + 1°C), 1000°C ÷ 1200°C ± (4% + 3°C)
Sonda tipo	"K"
Batteria	9 V

T063

€ 67,40

MISURATORE DI TEMPERATURA DIGITALE PORTATILE

Sonde tipo "K" per ambiente e per immersione, doppia rilevazione della temperatura, con scatola.



Scatola

Campo di misura	T056/TP01: -50°C ÷ 250°C
Campo di misura	T056/TP02: -50°C ÷ 750°C
Letture	1 °C
Precisione	-50 °C ÷ 1200 °C ±(0.3 % + 2 °C)
Precisione	1200°C ÷ 1300 °C ±(0.6 % + 2 °C)
Precisione	-58 F ~ 1200 F ±(0.3 % + 2 F)
Precisione	1200 F ~ 1999 F ±(0.6 % + 2 F)
Batteria	9 V



T055 € 145,00

MISURATORE DI TEMPERATURA DIGITALE PORTATILE

Sonde tipo "K" per ambiente e per immersione con custodia in plastica.



Scatola

Campo di misura	T056/TP01: -50°C ÷ 250°C
Campo di misura	T056/TP02: -50°C ÷ 750°C
Letture	0,1 F
Letture	0,1 °C
Precisione	±(0,3% n+1.8 F)
Precisione	±(0,3% n+1 °C)
Dimensioni	178 x 68 x 39 mm
Lunghezza totale sonda	120 mm
Batteria	4 x 1,5 VAA

F010 € 308,00

FONOMETRO INTEGRATORE DIGITALE

Alta precisione, modalità di rilevamento Fast, Slow, Max. Collegamento con computer per trasferimento dati.



Valigetta

Risposta di frequenze	31,5 Hz ÷ 8 kHz
Campo di misura	30 dB ÷ 130 dB (A) 32 dB ÷ 130 dB (C) 35 dB ÷ 130 dB (Lineare)
Letture	0,1 dB
Funzioni	SL, LN, Leq (livello equivalente)
Caratteristiche di rilevamento	Fast, Slow, Max
Tempo di misurazione	0,1 s
Display	10 mm
Temperatura di esercizio	-10 °C ÷ 40 °C
Batterie non incluse	4 x 1,5 V AAA
Tempo di risposta	1 s
Dimensioni	236 x 63 x 26 mm

T056/TP01 € 8,80

SONDA TIPO "K" PER TEMPERATURA AMBIENTE



Campo di misura	-50°C ÷ 250°C
Tipo sonda	"K"
Lunghezza sonda	2 mm

T056/TP02 € 10,80

SONDA TIPO "K" PER TEMPERATURA AMBIENTE O PER IMMERSIONE



Campo di misura	-50°C ÷ 750°C
Tipo sonda	"K"
Lunghezza totale	135 mm

T056/TP03 € 64,40

SONDA TIPO "K"

Per temperatura ambiente o per immersione



Campo di misura	-50 °C ÷ 1100 °C
Tipo sonda	"K"
Lunghezza sonda	650 mm

A005 € 206,00

ANEMOMETRO DIGITALE



Valigetta

MISURAZIONE VELOCITÀ DELL'ARIA	
Unità di misura	m/s - Km/h - ft/min - Knots
Gamma velocità madrina	0,4 ÷ 30,0 / 1,4 ÷ 108 / 80 ÷ 5910 / 0,8 ÷ 58,3
Letture	0,1
Precisione	± (2%+1 cifra) / ± (2%+3 cifre) / ± (2%+2 cifre) / ± (2%+2 cifre)
MISURAZIONE TEMPERATURA	
Campo di misura	0°C÷60°C 32 F÷140 F
Letture	0,1° C 0,1 F
Precisione	0,5°C 0.9 F
Batteria	9 V non inclusa

L014 € 72,00

LUXMETRO DIGITALE



Valigetta

Campo di misura	0 LUX ÷ 2000 LUX ÷ 20000 LUX ÷ 50000 LUX
Risoluzione	1 LUX
Precisione	± 5 %
Batteria	9 V

MD01 € 118,00

CERCAMETALLI

Analogico composto da 2 Led a colori per riconoscimento metalli. Sensore audio.



Scatola

Diametro bobina	170 mm
Connettore jack	1/4"
Sensibilità	> 15 cm per una moneta di Ø 25 mm
Batteria	9 V

C069 € 110,00

CONTAGIRI DIGITALE A CONTATTO



Valigetta

Velocità di rotazione	2,5 - 9999,9 rpm
Velocità tangenziale	0,05 - 999,99 m/min
Letture	0,1 (7,5 - 999,9) rpm
Letture	1 (1000-9999,9) rpm
Precisione	± 0,05 % + 1 cifra
Dimensioni	190 x 72 x 37 mm
Batteria	4 x 1,5 V AA

O387A € 67,40 **NEW**

RILEVATORE DIGITALE

per la misurazione di metalli ferrosi e non ferrosi, legno e cavi in tensione in pareti, soffitti e pavimenti.



Blister

Massima profondità di rilevazione	
Metalli ferrosi	100 ± 5 mm
Metalli non ferrosi	70 ± 5 mm
Legno	20 ± 5 mm
Cavi in tensione	50 ± 5 mm
Batteria	9 V
Dimensioni	150 x 75 x 24 mm

C070 € 154,00

CONTAGIRI DIGITALE OTTICO E A CONTATTO

Con strisce catadiottriche. alta precisione



Valigetta

Velocità di rotazione ottica	2,5 ÷ 9999,9 rpm
Velocità di rotazione contatto	0,05 ÷ 999,9 rpm
Velocità tangenziale	0,1 ÷ 999,99 m / min
Letture	0,1 (2,5 ÷ 999,9) rpm
Letture	1 (1000 ÷ 9999,9) rpm
Distanza d'uso	da 50 ÷ 60 mm a 50 ÷ 250 mm (con ottico)
Precisione	± 0,05 % + 1 cifra
Dimensioni	220 x 75 x 29 mm
Batteria	4 x 1,5V AA
Temperatura di esercizio	0°C ÷ 40°C
Tempo di misurazione	0.8 s

C067 € 110,00

CONTAGIRI DIGITALE OTTICO

Con strisce catadiottriche



Valigetta

Campo di misura	2,5 ÷ 9999,9 rpm
Letture	0,1 (2,5 ÷ 999,9) rpm
Letture	1 (1000 ÷ 9999,9) rpm
Distanza d'uso	da 50 ÷ 60 mm a 50 ÷ 250 mm
Precisione	± 0,05% della lettura + 1 cifra
Dimensioni	170 x 72 x 37 mm
Batteria	4 x 1,5V AA



0543 € 20,80

MISURATORE DI PRESSIONE PNEUMATICI E EMERGENZA AUTO

Ideale in condizioni di emergenza può essere utilizzato in 4 modi differenti: misuratore di pressione pneumatici, torcia elettrica a Led, martello rompi vetro di emergenza, taglia cintura di sicurezza.



Blister



Campo di misura	3÷150 psi 0,21÷10,34 bar 21÷1034 kPa
Temperatura di esercizio	-20°C ~ +50° C
Batteria	2 AA incluse

V002 € 1080,00

MISURATORE DI VIBRAZIONI

Completo di sonda magnetica, 2 puntali, software e cavo usb

Accelerazione	0,1 ÷ 400 m/s ²
Velocità	0,01 ÷ 40 cm/s
Spostamento	0,001 ÷ 4 mm
Equilibratura rpm	60 ÷ 99,990
Frequenza	1÷20 kHz
Precisione	± 5 %
Batteria	4 x 1,5 V AA



0836 € 17,30

MISURATORE DI PRESSIONE DIGITALE

Dotato di misuratore di spessore del battistrada e di luce al Led.



Blister



Campo di misura	0,5÷99,5 psi 0,034÷6,86 bar, 3,45÷686 kPa
Precisione	±1%
Batteria	3 x SR44 incluse

S004 € 1490,00

MISURATORE DI SPESSORI AD ULTRASUONI

Risoluzione	4-digit LCD
Campo di misura	1,0 ÷ 225,0 mm
Precisione	±0,1 mm
Dimensioni	126 x 68 x 23 mm
Batteria	2 x 1,5 V AA



0583 € 89,50

RIFRATTOMETRO BRIX



Valigetta

Campo di misura	0 ÷ 80 % Brix
-----------------	---------------

0433 € 82,10

RIFRATTOMETRO

Brix per controllo di oli emulsionabili



Valigetta

Campo di misura	0 ÷ 32% Brix
-----------------	--------------

0312 € 89,50

RIFRATTOMETRO TRIVALENTE PER LIQUIDI AUTO



Valigetta

Scala per liquidi antigelo E	-50 °C ÷ 0 °C
Scala per liquidi antigelo P	-50 °C ÷ 0 °C
Scala per liquidi batteria B	1,10 ÷ 1,40 SG
Scala per liquidi tergcristallo C	-40 ÷ 0°C

0312/AB **NEW** € 67,10

RIFRATTOMETRO PER LIQUIDI AUTO CON ADBLUE



Valigetta

Scala per liquidi antigelo E	-40 °C ÷ 0 °C
Scala per liquidi antigelo P	-50 °C ÷ 0 °C
Scala per liquidi batteria B	1,10 ÷ 1,40 SG
AdBlue	30 ÷ 35 %

D007/A

€ 78,50

DUROMETRO SHORE "A"

Misuratore di durezza per gomme morbide, pelle, feltro, cere



Campo di misura	0 ÷ 100 A
Letture	2 A

D011/A

€ 137,00

DUROMETRO DIGITALE SHORE "A"

Misuratore di durezza per gomme morbide, pelle, feltro, cere



Campo di misura	0 ÷ 100 A
Letture	0.5 A

D011/D

€ 137,00

DUROMETRO DIGITALE SHORE "D"

Misuratore di durezza per gomme dure e materie plastiche



Campo di misura	0 ÷ 100 D
Letture	0.5 D

P013

€ 143,00

PROVINI IN GOMMA SHORE "A"

Con durezza variabile da 26ha a 88ha. provini di colore viola, marrone, verde, arancione, rosso, giallo e grigio. precisione ±2ha



7 Pcs

D018 **FERVIplus**

PRO € 4660,00

DUROMETRO DA BANCO

Motorizzato, rockwell, brinell e vickers



Cassa di legno

Forza di misurazione	294,2 N / 306,5 N / 588,4 N / 612,9 N / 980,7 N / 1471 N / 1839 N; 30 kgf / 31,25 kgf / 60 kgf / 62,5 kgf / 100 kgf / 150 kgf /
Penetratore in diamante a cono e piramide	n° 1+1
Penetratore a sfera	n° 3
Incidini piani	n° 2
Incidine a V	n° 1
Blocchetti di taratura	n° 1 Brinell; n° 5 Rockwell; n° 1 Vickers
Ingrandimenti	37,5x - 75x
Altezza max del pezzo da misurare	Rockwell: 175 mm; Brinell - Vickers: 145 mm



Profondità di misurazione	160 mm
Alimentazione	230 V - 50 / 60 Hz - 6 W
Dimensioni durometro	525 x 240 x 730h mm
SCALE DI MISURAZIONE:	
HBS	4 - 450
HRB	20 - 100
HRA	20 - 88
HRC	20 - 70
HV	200 - 1000
Peso netto	70 kg



D001 **FERVIplus**

€ 2430,00

DUROMETRO DA BANCO ROCKWELL



Cassa di legno

Letture	0,5 HR
Penetratore a diamante e a sfera	n° 1+1
Incudini piani	n° 2
Incudine a V	n° 1
Blocchetti di taratura	n° 5 (HRC, 3xHRB, HRA)
Altezza max del pezzo da misurare	170 mm
Profondità di misurazione	125 mm
Dimensioni durometro	185 x 465 x 640 mm
Forza di misurazione	588,4 N / 980,7 / 1471 N (60 kgf / 100 kgf / 150 kgf)
SCALE DI MISURAZIONE:	
HRC	20 ÷ 70
HRB	25 ÷ 100
HRA	20 ÷ 88
Peso netto	90 kg



S110

€ 393,00

SCLEROMETRO

Per la misurazione di durezza dei manufatti in cemento



Energia di percussione	2.207 Nm
Tensione molla	7.84 N
Corsa	75 mm

S111

€ 434,00

INCUDINE PER TARATURA SCLEROMETRO



R004

NEW € 2500,00

RUGOSIMETRO PORTATILE DIGITALE

Per la misurazione dei parametri di rugosità Rz, Ra, Rq, Ry, Rt, Rv, R3z, R3y, RzJIS, Rsk, Rku, Rsm, Rmr, con uscita dati USB 2.0, grande display OLED di facile lettura e retroilluminazione, informazioni comprensibili e rappresentazioni grafiche, tastatore con stilo in diamante, 90°, raggio 5 µm, forza di contatto 4 mN (0,4gf), standard secondo ISO, DIN, ANSI, JIS, filtro digitale RC, PCRC, Gauss, D-T13565, memoria dati 2 MB + 2 GB, con batteria ricaricabile agli ioni di Litio, spegnimento automatico



Valigetta

Ra	0,005 ÷ 16 µm	Precisione	$\pm 10\%$
Rq	0,02 ÷ 160 µm	Ripetibilità	$\pm 6\%$
Cut off	0,25 0,8 2,5	Dimensioni	140 x 55 x 47 mm

B031 € 23,10

BILANCINA DIGITALE DI PRECISIONE TASCABILE

Non idoneo nei rapporti con terzi



Scatola

Capacità	100 g
Letture	0,01 g
Tipo di pesatura	g / dwt / tl / ct

B021 € 18,80

BILANCINA DIGITALE DI PRECISIONE TASCABILE

Non idoneo nei rapporti con terzi. funzioni tara e calibrazione



Scatola

Capacità	500 g
Letture	0,1 g
Tipo di pesatura	g / dwt / gn / ct
Alimentazione	2 x 1.5 Vdc Ministilo AAA

B003/5/1 € 33,60

BILANCIA ELETTRONICA DIGITALE

Non idoneo nei rapporti con terzi, funzione tara, autospegnimento



Scatola

Capacità	5 kg - 176,4 oz
Letture	1 g 0,1 oz
Batteria	2 x 1,5V AA
Dimensioni	170 x 240 x 35 mm

B018 € 122,00

BILANCIA ELETTRONICA DIGITALE CON DOPPIO DISPLAY

Non idoneo nei rapporti con terzi. Dotata di batteria 4 V 4 AH e caricabatteria. Memoria per valori unitari. Calcoli valori totali.



Scatola

Capacità	30 kg
Letture	10 g
Dimensione piatto	340 x 230 mm
Dimensioni	350 x 330 x 120 mm
Alimentazione	230V 50 Hz
Batteria ricaricabile	4 V 4 Ah

B004- BILANCIA ELETTRONICA DIGITALE CONTAPEZZI RICARICABILE

Non idoneo nei rapporti con terzi dotata di batteria 6V 4A e caricabatterie.

0561/B € 35,10

BATTERIA DI RICAMBIO

Per tutte le bilance B004



Scatola

Art.	€	Capacità	Letture	Dimensioni bilancia da banco	Dimensioni piatto	Batteria ricaricabile
B004/7	€ 374,00	7,5 kg	0,2 g	350 x 340 x 105 mm	335 x 228 mm	6 V 4 Ah
B004/30	€ 374,00	30 kg	1 g	350 x 340 x 105 mm	335 x 228 mm	6 V 4 Ah



B004/150

€ 729,00

BILANCIA ELETTRONICA DIGITALE CONTAPEZZI RICARICABILE

Non idoneo nei rapporti con terzi dotata di batteria 6V 4A e caricabatterie.

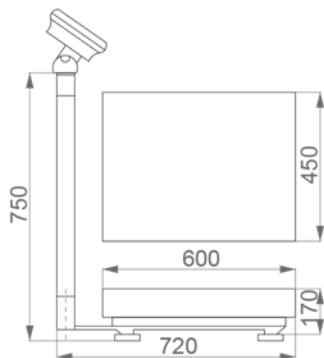

Scatola

Capacità	150 kg
Letture	10 g
Batteria ricaricabile	6 V 4 Ah
Peso netto	17 kg

D010-

NEW

DINAMOMETRI DIGITALI

Con struttura in fusione di alluminio, dotati di batteria, caricabatterie, telecomando ad infrarossi e segnale sonoro Doppia unità di misura kg / lb. Con funzioni di Picco, Hold, Tara, Zero e addizione. Caratteri grandi per una facile lettura. Non idoneo nei rapporti con terzi.



Scatola

Art.	€	Grandezza caratteri	Portata	Letture	Pesata minima	Carico limite	Batteria	Peso netto
D010/0100	€ 567,00	40 x 20 mm	1000 kg	0.500 kg	0.500 kg	150%	6 V 4 Ah	7,1 kg
D010/0300	€ 683,00	40 x 20 mm	3000 kg	1 kg	1 kg	150%	6 V 4 Ah	7,5 kg
D010/0500	€ 798,00	40 x 20 mm	5000 kg	2 kg	2 kg	150%	6 V 4 Ah	12,3 kg
D010/1000	€ 998,00	40 x 20 mm	10000 kg	5 kg	5 kg	150%	6 V 4 Ah	25,7 kg

D012-

PRO

DINAMOMETRI DIGITALI

Dotati di batteria, caricabatterie, radiocomando, retroilluminazione e segnale sonoro Doppia unità di misura kg/lb. Con funzioni di Picco, Hold, Tara e Zero. Caratteri grandi per una facile lettura. Non idoneo nei rapporti con terzi.



Scatola

Art.	€	Grandezza caratteri	Portata	Letture	Pesata minima	Carico limite	Batteria ricaricabile	Peso netto
D012/0100	€ 855,00	40 x 20 mm	1001 kg	0,200 kg	0,200 kg	150%	6 V 10 Ah	12 kg
D012/0300	€ 1010,00	40 x 20 mm	3001 kg	0,500 kg	0,500 kg	150%	6 V 10 Ah	14,5 kg
D012/0500	€ 1170,00	40 x 20 mm	5001 kg	1 kg	1 kg	150%	6 V 10 Ah	19 kg
D012/1000	€ 1390,00	40 x 20 mm	10001 kg	2 kg	2 kg	150%	6 V 10 Ah	32 kg

ART	PAG	ART	PAG	ART	PAG	ART	PAG
0010	369	0048	499	0093/42	462	0139-	557
0011	057	0049	496	0094	360	0140-	331
0012	056	0050	495	0095	456	0141	461
0013/142	566	0051	495	0096	455	0142-	098
0013/185	566	0052	492	0096/L	457	0143/25	378
0018/15	396	0054/10	357	0101/500	463	0143A	378
0018/30	396	0054/4	357	0102	075	0144	091
0019-	401	0056-	371	0103	471	0145-	331
0020	441	0058	439	0104	435	0146/60	332
0020/1	441	0059	496	0105	483	0147	361
0020/2	441	0060	359	0105T	482	0148/500	447
0020/3	441	0062-	368	0106	068	0148/64	530
0020/4	441	0063	360	0107	519	0148/72	530
0020/5	441	0064	376	0109	562	0148/73	530
0020/6	441	0065A	358	0110	483	0149	488
0021/1	360	0066	375	0110T	482	0151	464
0021/2	360	0067	359	0112	562	0152	450
0022	072	0068/S	376	0113	076	0153-	446
0023	067	0068L	376	0115	495	0154-	446
0024	504	0069-	359	0116	466	0156-	506
0026	504	0070	375	0116P	466	0157-	335
0027/30W	503	0070/C	375	0118	444	0158/500	506
0027/40W	503	0071	505	0119	444	0159	459
0027/40W/TIP	503	0073	385	0120	444	0160	452
0028	376	0075	369	0121	444	0161	459
0028R	376	0076	396	0122	443	0162	451
0029	566	0077	396	0123	521	0163	302
0031	503	007x	395	0124	439	0164/250	506
0033A	503	0080	397	0125	497	0165	485
0033A/TIP	503	0081	461	0126	449	0166	451
0034	505	0082	432	0127	449	0167-	334
0035	456	0083	431	0128A	519	0168	451
0036-	331	0084-	388	0129-	557	0169-	447
0036-xG	331	0085	469	0130-	445	0171-	506
0037	503	0087	212	0132	063	0172/150	506
0037/TIP	503	0087/35	212	0132-	557	0173	401
0038	345	0088	423	0133	063	0174-	331
0042-	332	0089	433	0134-	387	0176	468
0043	471	0090	391	0134S	387	0177	467
0044	492	0090-	391	0135-	331	0178	465
0045	492	0091	469	0136	443	0179	466
0046	494	0092	462	0137	398	0180	466
0047	494	0093/22	461	0138	091	0181	413

ART	PAG	ART	PAG	ART	PAG	ART	PAG
0183/750	506	0220	393	0266	388	0308	401
0184-	470	0220/C	393	0267	454	0310	341
0186	052	0221	385	0268A	398	0310B	342
0187	387	0222	385	0269	391	0311	520
0188-	099	0222-	385	0271	357	0312	571
0188-xG	099	0223	385	0272	513	0312/AB	571
0189-	511	0224-	385	0273	061	0313	495
0189/G	511	0225-	445	0274	512	0315	485
0190	393	0226	459	0277	436	0316	068
0192	454	0227-	445	0278-	189	0317	468
0194	511	0228	401	0278/002S	189	0318	468
0195	411	0229	465	0278/005S	189	0320	454
0196	387	0231	465	0278/008S	189	0321	505
0196-	387	0232	346	0278/009S	189	0322	463
0197	075	0233	346	0280	083	0323/45	326
0198	454	0234	469	0285/75	072	0323/55	326
0199	384	0235	073	0286-	557	0325	461
0199P	384	0236	372	0287-	462	0327	459
0199P-	384	0237-	372	0289	512	0329	399
0200	383	0238	212	028x	471	0331	293
0201	383	0239/400	447	0290	344	0332	208
0201-	383	0240/15	502	0291	520	0333	505
0202	454	0241	366	0292-	076	0333/150	505
0203	345	0242	055	0293	468	0334/0750	072
0204	384	0243-	447	0294	465	0334/1000	072
0205	333	0245	432	0295	464	0338	520
0205/120	333	024xE	443	0296	465	0339	494
0206	444	024xI	443	0297	462	033x	447
0207	432	0250	334	0298	465	0340S	388
0208	384	0252/230V	051	0299	466	0341	420
0208-	384	0252/400V	051	0299/P	466	0341/3LS	421
0209	519	0253	462	0300	451	0341/5S	421
0211	346	0254	330	0301-	451	0341-Sx	421
0212	558	0255	062	0302/200	089	0341-x	420
0214	452	0256-	368	0302/245	089	0341-xL	421
0215x	391	0257	466	0302/305	089	0342	522
0216/400	447	0258	450	0303	511	0343	516
0217	366	0259	450	0304	433	0344	517
0218-	515	0260	056	0305	345	0350	304
0218/50T	516	0261	467	0305/0203/1118	347	0352-	396
0218-xB	515	0263	466	0306	451	0353/085	334
0218-xS	515	0264	330	0307/1	467	0353/110	334
0219	452	0265/05	335	0307/2	467	0355	431

ART	PAG	ART	PAG	ART	PAG	ART	PAG
0356	511	0400	393	0444	504	0485	356
0357-	396	0400-	392	0445/20	521	0486	345
0358	434	0401	521	0446	566	0487	340
0359-	395	0402	435	0447	364	0490	340
035x	334	0403	435	0449	562	0490/03	343
0360	399	0404	435	0451	397	0490/11	343
0362	062	0405	394	0452	366	0490/20	344
0363-	322	0405-	394	0453	439	0492	519
0365	084	0406	433	0454	439	0493/1	518
0366	516	0407	433	0455	439	0493/2	518
0367	459	0409	330	0456	423	0494-	400
0368-	445	0411	457	0457	358	0495	093
0369	358	0412	497	0458	494	0495/24	094
0370-	445	0413	493	0459	273	0496	093
0371	127	0414	493	0460	494	0497-	078
0372	127	0415	457	0461	371	0498	079
0373-	445	0416	493	0462	341	0499	080
0375A	358	0417	493	0462/55	344	0499/C	081
0376/AC	464	0418	493	0463	212	0500	062
0376/AI	465	0419	493	0465	467	0502	068
0376/AL	465	0420	457	0466/4V	326	0503	068
0377	066	0420/S	457	0466/CV	326	0504	082
0378/1510	501	0421	494	0466/DM	432	0505	090
0379	444	0422-	327	0466/PB	326	0506	025
0380	468	0423/1	326	0466/SC	326	0507	093
0381	450	0423/2	326	0467	369	0507/07	094
0382-	322	0424	461	0468	467	0507/14	094
0384	458	0425-	108	0469	439	0507/15	094
0385	512	0426-	397	0470	439	0507/4R	094
0386	512	0427-	331	0471	423	0507/Y	094
0387A	570	0428	523	0472	462	0509/245	087
0390	330	0429	522	0473-	506	0509/305	087
0391	449	0430	366	0474/PA	513	0509/340	087
0392	346	0431	505	0474/PE	513	0510	067
0393	389	0432	364	0474/PP	513	0511	446
0393-	389	0433	571	0476	386	0513	463
0393/A	389	0434	484	0476-	386	0514-	446
0394-	334	0437	518	0477	386	0515	463
0395	330	0439-	400	0478	364	0516	517
0396	450	0441	504	0479	364	0517/59	081
0397	519	0442	389	0481/15	501	0517A	080
0398	467	0442-	389	0482/3	518	0518/20	058
0399	484	0443	504	0483	074	0518/30	058



ART	PAG	ART	PAG	ART	PAG	ART	PAG
0518/38M	059	0558/EM	392	0590	375	0630/0900	363
0518/50	058	0558/EP	392	0591-	331	0630/2200	363
0518/55H	059	0558/GE	391	0592	362	0630/2720	363
0518/80	059	0558/TX	393	0594	362	0632	346
0519	452	0559	082	0595	362	0632-	346
0520-xA	332	0559/T	082	0596	362	0632/01	347
0520-xF	332	0560	072	0597	520	0633	429
0520-xG	332	0561/B	574	0598	362	0634	430
0520-xP	332	0562	433	0599	038	0635/25	373
0520-xS	332	0562N	433	05x	343	063xE	443
0521	469	0563-	108	0600	372	063xI	443
0522	063	0564	090	0601	338	0640	436
0523	090	0565	064	0601/24	343	0641	496
0524	213	0567	358	0601/30	343	0642	064
0526	213	0568	064	0602	372	0644	496
0529	211	0569	342	0603	443	0645/C	367
0530	517	0570	495	0604	469	0645/CC	367
0531A	127	0571	492	0605	338	0645/CP	367
0532A	127	0573	491	0606	470	0645/S	367
0532A/230V	127	0574	495	0607	497	0645/SS	367
0536	128	0575	339	0608	497	0646/A	562
0536A	128	0575/04	343	0609	497	0647/25	458
0537A	127	0575/0580/12	344	0610	497	0647/25L	458
0538A	128	0575S	339	0611	456	0647/50	458
0540-	390	0576	492	0612	455	0647/50L	458
0540/3	390	0577/17	344	0613	455	0647/65	458
0540S	390	0578-	342	0614	388	0647/65L	458
0541S	387	0579-	342	0614-	388	0648	078
0543	571	0580	340	0615	338	0649-	362
0544	383	0580/01-6	343	0617	455	0651/6S	523
0545/EF	391	0580S	340	0618	415	0654-xF	379
0545/TF	393	0581	342	0620	413	0654-xL	379
0546	383	0582-	342	0621/A3	523	0655/L	460
0548	433	0583	571	0622	414	0655/R	460
0551	066	0584-	464	0623	455	0655/S	460
0552	066	0585	488	0624	412	0656/254	083
0552/400V	066	0585-	464	0625	518	0656/310	083
0553	066	0586	489	0626	434	0657	025
0554	066	0587	488	0626L	434	0657/B	026
0554/400V	066	0587-	464	0627	455	0658	359
0555	068	0588-	464	0627/L	456	0659	518
0556	066	0588/6	489	0628	442	0659-	518
0557	330	0589	412	0629	459	0660-	511

ART	PAG	ART	PAG	ART	PAG	ART	PAG
0661	517	0697	081	0739-	453	0776	073
0662	071	0698/100	098	073x	448	0776/610	073
0663	357	0699/240	460	0740-	453	0777/2	500
0664	357	06x	373	0741-	453	0777/3	500
0665	082	0700-	382	0742-	453	0780	446
0666	562	0700/07P	382	0747	471	0781	446
0668	075	0700/12P	382	0748	471	0782	378
0670	460	0706	505	0749	080	0783-xF	500
0670/U	460	0708	025	0749/C	081	0783-xM	500
0671/1P	519	0709	304	0749/M	081	0784	496
0671/8	519	0710	026	0749/MC	081	0785-xF	500
0672	460	0711-	109	0750	055	0785-xM	500
0672/B	461	0712-	190	0750CM3	055	0786	492
0673	461	0712/002	190	0751	077	0787	519
0677	507	0712/005	190	0751/A4	108	0789	439
0677/500	507	0712/008	190	0751/P	108	0791-	375
0677/500CG	507	0712/009	190	0752	052	0792	456
0677/CG	507	0712/010	191	0752CM3	052	0792/L	457
0677/IA	507	0712/900	191	0753/A	091	0793	503
0677/SO	507	0712-x0	191	0753/L	091	0794-	447
0678	469	0712-x00	191	0754/230V	051	0795/1	411
0679	412	0713/15	516	0754/400V	051	0795/2	411
0682	329	0713/18	516	0755	513	0799-	212
0683	329	0713/27	516	0756	093	07x	238
0686/200	081	0714	388	0756/F	094	0801	463
0686/200C	081	0715-	125	0756/S	094	0803-	399
0687	339	0716	026	0756/T	094	0803/S080	399
0687/005	343	0716/B	026	0756/Y	094	0803/S210	399
0687/029	343	0716S	026	0757	043	0804	070
0687/041	344	0717A	089	0758	077	0804/MD	071
0687/102	344	0718	213	0758/C	077	0805/400	563
0688	122	0719	076	0759	093	0806/020	398
068x	329	0720	091	0759/F	094	0806/200	397
0690-	382	0720/L	091	0759/S	094	0808-	447
0690/07P	382	0721	075	0760	471	0809-	397
0690/12P	382	0722	076	0762-	238	0813	442
0691/400V	071	0723	076	0764	086	0814	442
0692/230V	061	0724/B	459	0764/455	086	0815-	398
0692/400V	061	0725	497	0765	091	0816	302
0693A	520	0725L	497	0773-	074	0817	302
0694	504	072x	448	0773/05L	074	0818/250	460
0696	456	0737-	453	0773/10L	074	0819-	470
0696/L	456	0738-	453	0775	074	0820-	470



ART	PAG	ART	PAG	ART	PAG	ART	PAG
0821/14	470	0876	467	A003/32CBN	071	A007S	312
0822	470	0877	468	A003/32SDC	071	A007T	313
0823	470	0878	339	A004/14	070	A007U	313
0824-	563	0880/307	430	A004/14CBN	071	A007UF	313
0826	443	0881/008	430	A004/14SDC	071	A007V	313
0827	084	0887	429	A004/20	070	A007-xP	316
0829	432	0888	432	A004/20CBN	071	A008A	309
0830	213	0889	520	A004/20SDC	071	A008B	309
0831-	444	0890	219	A005	569	A008C	309
0833	305	0890-	219	A007/01	315	A008D	309
0834-	444	0892	075	A007/02	314	A008E	310
0835/15	213	0893	076	A007/03	314	A008F	310
0836	571	0895-	386	A007/04	314	A008G	310
0839-	448	0896-	386	A007/05	314	A008H	310
0839-xT	448	08x	442	A007/06	314	A008I	311
0840	522	08xx	442	A007/07	315	A008L	311
0841	442	0900	522	A007/10	315	A008M	311
0842	463	0900/BL	522	A007/11	315	A008N	311
0843	442	165x	164	A007/16	315	A008P	312
0844	462	16Ax	114	A007/17	314	A008Q	312
0846/150	463	16-B	114	A007/18	314	A008R	312
0847	442	16-CM	114	A007/20	315	A008S	312
0849	322	16-D	114	A007/21	315	A008T	313
0855	088	16ERx	164	A007/21I	315	A008U	313
0855-	394	16IRx	164	A007/22	315	A008UF	313
0856-	392	1-xA	110	A007/23	314	A008V	313
0857	043	1-xD	110	A007/LED	316	A010-	523
0861	470	2622x	108	A007/LED/C	316	A010/20G	523
0862	463	2-xA	116	A007A	309	A010/30	523
0864	504	2-xB	116	A007B	309	A010/30T	523
0865	504	2-xD	117	A007C	309	A010-x	523
0869	459	3/B/40	112	A007D	309	A013/26	069
0870/250	084	3A40-	112	A007E	310	A013/26M	071
0871	084	3-CM	112	A007F	310	A0132A	069
0872/OPD	440	3D40-	112	A007G	310	A0132A/MB	071
0872/P	440	4-	115	A007H	310	A0132A/MR	071
0872/PCD	440	4-xB	115	A007I	311	A014-	195
0872/PDD	440	4-xD	116	A007L	311	A014/03-30S	195
0873/TF	441	A001-	111	A007M	311	A015-	551
0873/TL	440	A003/13A	069	A007N	311	A016-	546
0873-BC	440	A003/13ACBN	071	A007P	312	A017x	552
0873-BD	440	A003/13ASDC	071	A007Q	312	A018x	552
0873-U	440	A003/32	069	A007R	312	A019-	555

ART	PAG	ART	PAG	ART	PAG	ART	PAG
A020	546	ACAS/009	349	B018	574	BN434Nx	405
A021	547	ACAS/010	349	B019	318	BN443Lx	409
A024/10	347	ACAS/011	349	B019/G030	318	BN443Nx	409
A024/602	348	ACAS/012	349	B021	574	BN444Lx	406
A025/30	347	ACAS/013	349	B022/10	317	BN444Nx	406
A040/30A	347	ACAS/014	349	B022/15	317	BN445Nx	403
A040/60A	348	ACAS/015	349	B025	555	BN4C3Lx	409
A040/802	348	ACAS/017	349	B031	574	BN4C4Lx	406
A040/8029	349	ADF-	281	B040-	556	BN4E2Nx	410
A040/803	348	ADLTx	161	B0x	550	BN4E3Lx	407
A040/8037	349	ADLTxA	161	B100	553	BN4E3Nx	407
A040/8040	349	ADLTxA1	161	B201/1	553	BN4E4Lx	404
A040/8046	349	ADR3/6	264	B201/2	553	BN4E4Nx	404
A040/8047S	349	AN2G/12/1	373	B201/3	553	BN4E5Lx	402
A040/8047U	349	AP01	490	B201/4	553	BN4E5Nx	402
A040/8048	349	AP02	490	B609	514	BN4P2Nx	410
A059	070	AP03	490	B610	514	BN4P3Lx	407
A059/M	071	AP04	490	BASECKJNL	150	BN4P3Nx	407
A100	319	AP05	491	BASECKJNR	150	BN4P4Nx	404
A12AL6	199	AP05/150	491	BGAx	288	BN4P5Nx	402
A162A	499	AP06	491	BI413L0x	417	BRAS4103x	166
A162C	499	APKTx	161	BI423Lx	417	BRAS4104x	166
A162DS	499	AxDC	198	BI433Mx	417	BRAS4109x	166
A208B-	192	AxSC	198	BI443Mx	417	BRAS4111x	166
A212-	192	B001-	118	BI4E1Lx	419	BRCIx	166
A300	319	B003/5/1	574	BI4E1Nx	419	BRFEx	165
A481/10	501	B004-	574	BI4E2Lx	418	BRFlix	165
A481/15	501	B004/150	575	BI4E2Nx	418	BSAx	288
A481/15H	501	B005-	165	BI4E3Lx	416	BSCL09	150
A481/30H	501	B006-	449	BI4E3Nx	416	BSCL12	150
A601A	498	B007-	133	BN413Lx	408	BSDJ11	150
A601DS	498	B009/A1	318	BN413Nx	408	BSER16	150
A602A	498	B009/A2	318	BN414Lx	405	BSNR16	150
A901A	499	B009/B1	318	BN414Nx	405	BSSS12	150
A902A	499	B009/B2	318	BN415Nx	402	BSTG16	150
ACAS/001	349	B010	555	BN423Lx	408	BSVJ16	150
ACAS/002	349	B012-	166	BN423Nx	408	BU3550	150
ACAS/003	349	B013-	167	BN424Lx	405	BU4050	150
ACAS/004	349	B014-	167	BN424Nx	405	BU4560	150
ACAS/005	349	B015	317	BN425Nx	403	BxAL	199
ACAS/006	349	B015/10	317	BN433Lx	408	BxDC	199
ACAS/007	349	B017	317	BN433Nx	408	BxDCxL	199
ACAS/008	349	B017/C	317	BN434Lx	405	BxSC	199

ART	PAG	ART	PAG	ART	PAG	ART	PAG
BxSCxL	199	C046-	121	C182	371	C960/B7	324
C001-	206	C047-	537	C189	371	C960/B8	325
C002	544	C047-xB	537	C190	323	C960/CC01	474
C002/42	545	C048	545	C190C	472	C960/F6	323
C003-	206	C049/300	539	C245-	395	C960/F7	324
C004	544	C050-	121	C312	327	C960/F8	324
C005/150	537	C051	102	C313	327	C960C	472
C006-	538	C052	102	C315	327	C960CB	473
C007-	540	C053-	121	C360	327	C980	323
C009	370	C054	102	C371	327	C980/CC01	473
C010/200	540	C055-	121	C391-	395	CB01-	425
C010/200P	540	C056/200	539	C395-	395	CB01/04P	426
C011-	538	C057/150	538	C586	488	CB01/07P	426
C012-	449	C058	559	C589	489	CB01/11P	426
C014-	546	C058/52	559	C600	319	CB02-	425
C015	449	C060	544	C600-	320	CB02/04P	426
c015-	449	C061	547	C603	319	CB02/07P	426
C016	546	C062	547	C603-	320	CB02/11P	426
C017	544	C063	547	C648	328	CBF1-	425
C018-	538	C063/L	547	C650	370	CBF1/10P	426
C019/150	539	C064	544	C670	323	CCGx	286
C020-	540	C065/2	370	C700	320	CCMTx	154
C021-	539	C067	570	C750	370	CCMTxA	154
C022/100	073	C069	570	C800	319	CF08	541
C023	544	C070	570	C800-	320	CHERx	113
C023/N	544	C075/2	370	C855-	394	CI80/006	430
C023G	544	C076/30	075	c856-	392	CI82-	430
C025-	551	C080-	320	C880/006	429	CI83-	430
C025-3x	551	C085-	320	C881-	429	CKJNx	135
C026-	559	C086/01C	321	C881/006	429	CKUNR	139
C027-	559	C086/01T	321	C882-	428	CN450N0/0	400
C028-	560	C086/02C	321	C882/2038	428	CN450Nx	400
C029-	560	C086/02T	321	C883-	428	CNMGx	154
C030-	379	C086/04C	321	C884-	428	CNMGxF15	154
C031/150	536	C086/04C/D	321	C884/6038	428	CNMGxF25	154
C033-	536	C086/04T	321	C885-	428	CNMGxM25	155
C035-	536	C086/12C	321	C885/2038	429	CNMGxM35	155
C038/30	358	C086/12C/D	321	C900/A	325	CP05	524
C039/15	359	C087	322	C900/B	325	CP090S	524
C039/25	359	C090-	322	C900/CC01	474	CR20x	468
C041/150	536	C1102	371	C902/B	325	CRDxC	277
C043-	537	C163	327	C960/AM01	475	CRDxT	277
C044-	540	C165	327	C960/B6	324	CSCD-	281

ART	PAG	ART	PAG	ART	PAG	ART	PAG
CSDS-	281	D883-	427	DFVx-xZ	269	E010E	223
CSF-	281	D884-	427	DLFx	283	E010-MxE1	229
CTFP10/12	150	D884/6038	427	DMV150	286	E010-MxE15	230
CTFPBASE25/32	150	D885-	427	DN2100-A	258	E010-MxE2	230
CTFPx	139	D885/2038	427	DN2100-Z	257	E010-MxE25	231
CTMTMC16/20	150	DC200	286	DN2300-Z	257	E010-MxE3	231
CTMTMC25/32	150	DCGx	286	DN4100-A	255	E010-MxExA	232
Cx	370	DCK100	285	DN4100-Z	253	E010-MxExC	226
CxAL	200	DCMTx	155	DN4300-A	255	E010-UNCxEx	233
CxDC	200	DCMTxA	155	DN4300-Z	253	E010-UNFxEx	233
CxSC	200	DCTx	285	DN4550-Z	253	E011/BSF	227
D001	573	DCVx	285	DN6100-A	251	E011/BSW	227
D003	100	DF2100-A	258	DN6100-Z	249	E011/M140X125B	226
D004-	102	DF2100-Z	256	DN6300-A	251	E011/M140X125MCB	226
D005-	101	DF2150-A	258	DN6300-Z	249	E011/MC	226
D006-	102	DF2150-Z	256	DN6550-Z	249	E011/UNC	228
D007/A	572	DF4100-A	255	DN8100-A	247	E011/UNF	228
D009/5-12	211	DF4100-Z	252	DN8100-Z	245	E011A	224
D009/5-85	211	DF4150-A	255	DN8300-A	247	E011-Ax	237
D010/0100	575	DF4150-Z	252	DN8300-Z	245	E011B	224
D010/0300	575	DF4600-Z	254	DN8550-Z	245	E011-BSFx	227
D010/0500	575	DF6100-A	251	DN9100-ZC	260	E011-BSFxM	235
D010/1000	575	DF6100-Z	248	DN9101-C	261	E011-BSPx	228
D011/A	572	DF6150-A	251	DNMGx	155	E011-BSPxM	236
D011/D	572	DF6150-Z	248	DNMGxM25	156	E011-BSWx	227
D012-	575	DF6600-Z	250	DNMGxM35	156	E011-BSWxM	235
D018	572	DF6700-Z	250	DNW100	286	E011C	224
D020	211	DF8100-A	247	DSCx	285	E011D	224
D023	100	DF8100-Z	244	DSK100	285	E011-Ex	237
D040-	305	DF8150-A	247	DSTx	285	E011-M140x125Ex	226
D045-	303	DF8150-Z	244	DxAL	200	E011-Mx1	225
D050	211	DF8600-Z	246	DxDC	200	E011-Mx2	225
D054-	304	DF8700-Z	246	DxSC	200	E011-MxC	226
D055-	304	DF9100-ZC	259	E001	423	E011-MxM	234
D059-	303	DF9101-C	261	E002-	111	E011-MxM2	234
D060-	303	DF9103-M	262	E003	423	E011-MxMC	235
D070-	303	DF9150-ZC	259	E005	423	E011-UMx	237
D100	302	DF9153-M	262	E010	223	E011-UNCx	228
D100/S	302	DF9800-ZC	260	E010-	223	E011-UNCxM	236
D17x	270	DF9801-C	261	E010B	223	E011-UNFx	229
D880/006	427	DFC115/M14	284	E010-BSFxEx	232	E011-UNFxM	236
D882-	427	DFFx	284	E010-BSPxEx	233	E011-Ux	237
D882/2038	427	DFVx-xA	269	E010-BSWxEx	232	E022/12	565



ART	PAG	ART	PAG	ART	PAG	ART	PAG
E022/5	565	F015/007	187	F639	195	GCMX	164
E022/P	565	F015/008S	187	F68x	561	GCMXA	164
E023/5	565	F015-A	187	F80x	561	GL345-	525
E190-	424	F018	461	FC94/245	088	GL347-	525
E190-Bx	424	F019-	185	FC94/350	088	GL349-	525
E191-	424	F019/005	185	FCGx	286	GL365-	526
EN403Nx	409	F019/006	185	FD0x-	106	GL373-	526
EN404Nx	406	F019/007	185	FDCx	269	GL386-	527
EN405Nx	403	F019/008	185	FGx	558	GL396-	527
ERW100	267	F025	195	FGx-AI	558	GL398-	527
EW152	528	F050	032	FLIx	276	GL503-	527
EW154	528	F050I	032	FP120	529	GL516-	526
EW205	528	F050U	031	FP144	529	GL642-	525
EW207	528	F060	031	FP166	529	GL650-	525
EW210	528	F060I	030	FP190	529	GL711-	527
EW213	528	F060V	030	FP192	529	GL722-	526
EW249	528	F090-	400	FP194	529	GL762-	526
EW257	528	F121-	220	FPA120-	280	GL764-	526
ExAL	201	F122-	220	FRFx	265	GL814-	525
ExDC	201	F123	220	FSAx	288	Gx	318
ExSC	201	F23x	195	FTRx	275	GxAL	202
F001/10	197	F256-	148	FTx-1000	374	GxDC	202
F001/20	197	F256/644	150	FTx-2000	374	GxSC	202
F002-	182	F256/648	150	FTx-3000	374	HC001	524
F002/6	182	F2Gx	561	FW077-	533	HP205	531
F002/P	183	F300-	146	FW131-	533	HP207	531
F002/PL	183	F301-	146	FW542-	533	HP601	531
F002-xL	183	F302-	146	FxAL	201	HP603	531
F002-xP	182	F303-	148	FxDC	201	HT125	559
F002-xPL	183	F304-	147	FxSC	201	HxAL	202
F005-	196	F306-	146	G001-	220	HxDC	202
F006-	196	F307/16/22	149	G002-	219	HxSC	202
F007-	196	F308-	148	G003-	219	I002	568
F008-	205	F32x	561	G004-	564	I109	422
F008DC	205	F400-	147	G005	564	I217	421
F008SC	205	F401-	147	G006-	564	I306	421
F010	569	F402-	147	G007-	136	I340	420
F011-	181	F403-	149	G008	564	IS25-ESx	437
F011/6	181	F406-	149	G009	448	IS25-PHx	437
F011-xP	181	F407-	148	G030-	508	IS25-PHxAS	437
F015-	187	F430	195	G090-	400	IS25-PZx	437
F015/005	187	F585	488	G0x	113	IS25-PZxAS	437
F015/006S	187	F588/6	488	G900	521	IS25-TGx	437

ART	PAG	ART	PAG	ART	PAG	ART	PAG
IS25-TXx	437	L085	563	M028-	095	M16x	300
IS50-ESx	437	L090A	563	M028-xG	096	M218	215
IS50-PHx	438	L10AL6	203	M028-xGR	096	M300/B	328
IS50-PZx	438	L150	564	M029	215	M312/C	214
IS50-TGx	438	L200	563	M030	215	M312/P	214
IS50-TXx	438	LBx	238	M032	214	M430/B	328
JI40xL	422	LN400N1/2A	409	M033	548	M449-	106
JI40xN	422	LN400N1/4A	403	M033-	548	M449-xGBD	108
JN402NA	410	LN400N3/4A	410	M033-x	548	M449-xST	108
JN403NA	409	LN400N3/8A	406	M034/120	098	M505/B	328
JN404NA	406	LxDC	203	M036	214	M530-	097
JN405NA	403	LxSC	203	M038	125	M540/BT	328
JxDC	204	M001-	098	M040	350	MBGxA	301
JxSC	204	M001-x	217	M040/CF	350	MBGxC	302
K001-	105	M001-xV	217	M040/CP	350	MBx	300
k002-	105	M002-	217	M040/D	350	MCDxZ	263
KICAN	140	M002-xV	217	M040/SA	350	MCG2050/06G	301
KISCLCR	136	M003-	218	M040/SP	350	MCGxA	301
KISER	140	M003-xV	218	M040/ST	350	MCGxC	301
KISNR	140	M003-xxV	218	M041	350	MCGxS	301
KISTCMT	136	M003-xxx	218	M042-	109	MCLNBASE25/32	150
KISTFCR	137	m004-	115	M049-	106	MCLNx	138
KITCKJ	133	M005-	107	M049-xGBD	107	MD01	570
KNUX	156	M006-	333	M049-xST	107	MDAxZT	270
KVx	150	M007-	333	M050/13	109	MDFx	283
KxDC	204	M009-	549	M051-	109	MDUx	282
KxSC	204	M010-	549	M052-	109	MFDxZ	263
L006	518	M011-	095	M055	546	MFDxZC	263
L007	454	M011-xG	096	M055/120	546	MFGx	284
L008	521	M012-	096	M057/16	081	MGx	300
L011	452	M013/0/100	549	M059-	117	ML40	567
L012	452	M014-	097	M060-	117	ML80A	567
L012/PIA	452	M015S	214	M061	096	MSCx	279
L013	452	M018-	333	M062	546	MSD4x	299
L014	570	M019-	549	M069	565	MSD6x	298
L018-	193	M019-x	549	M071	565	MSD7x	299
L018S	193	M020	214	M072	565	MSD8x	298
L019-	193	M021-	548	M080-	110	MTD4x	296
L019S	193	M022-	548	M081-	110	MTD6x	296
L020	194	M023-	097	M100	215	MTD7x	297
L020-	193	M024-	097	M101	215	MTFNBASE25/32	150
L020S	193	M026-	548	M10AL6	203	MTFNx	139
L080	563	M027-	098	M13x	328	MTP4x	296



ART	PAG	ART	PAG	ART	PAG	ART	PAG
MTP6x	295	P012-LxP	351	P039/PR	352	P440	119
MTP7x	297	P012-N	351	P045	170	P444-	107
MTP8x	295	P012-NxP	351	P046	170	P450	119
MTP9x	297	P013	572	P049-	207	P4CS	120
MVx	300	P014	099	P04x	556	P880/06S	432
Mx	126	P015	099	P050-	207	P881-	431
MxDC	203	P017	099	P051-	207	P881/06S	432
MxSC	203	P018-	125	P052-	212	P882-	431
N12DC6	204	P019	371	P052/08S	212	P883-	431
N7x	239	P020	352	P056-	179	P886-	431
N7x1	239	P020/P	352	P056/10S	179	PARx	280
NAS100x-A	266	P021	351	P057	178	PAS-	283
NAS100x-C	267	P022-	356	P058-	175	PAV	316
NAS100x-Z	266	P023-	172	P058/170	175	PC40	120
NAT100x	267	P023/19	172	P061	175	PC40/R	120
NTxA	278	P023/25	172	P062	175	PC4P	120
NTxZ	278	P023-xC	173	P063-	207	PC50	120
NWS100	268	P023-xL	173	P064-	177	PC50/R	120
NWS100/M	268	P023-xL1	173	P064/19A	177	PCLNx	134
NxSC	204	P023-xL2	174	P064/25A	177	PCR6338	277
OFEXx	161	P023-xL3	174	P065-	176	PDBx	272
OFEXxA	162	P024/06	512	P067	176	PDC1-	373
ONMXxA	162	P024/15	512	P068	175	PDC2-	373
OX05C	524	P028-	356	P069	176	PDC4-	373
OX090	524	P029-	356	P075	566	PDJNRKIT	150
OX090S	524	P031-	209	P076-	208	PDJNx	135
OX20C	524	P031/03S	209	P076/006S	208	PDMx	272
P001/04	355	P031/05S	209	P076/008S	208	PDVx-M14	273
P001/10	355	P031/06P	209	P076-Gx	208	PFBx	270
P001/12	355	P031/06S	209	P076-Gx400	208	PFLx	273
P001/20	355	p032-	113	P076-Px	208	PFSx	270
P001/30	354	P032/18P	113	P077-	105	PI063	434
P001/45	354	P032/7P	113	P078-	105	PI401x	422
P001/75	354	P033-	210	P079-	105	PI402x	418
P002	351	P033/03S	210	P080	566	PI403x	417
P005	351	P034-	210	P081-	179	PI453x	417
P007-	560	P034/05S	210	P100/250	126	PIF1	433
P008/102	073	P034/06S	210	P101-	126	PLV175	287
P009	319	P035-	211	P20x	560	PMEx	273
P010/41	175	P035/04S	211	P30x	560	PN402Nx	410
P010/51	175	P036-	196	P340	119	PN403Nx	409
P011-	560	P037-	196	P350	119	PN404Nx	406
P012-L	351	P039	352	P40VD	316	PN405Nx	403

ART	PAG	ART	PAG	ART	PAG	ART	PAG
PNS	287	RICAPCLN	150	S017	367	S169	283
PPSx	273	RICAPSSN	150	S018	438	S179	415
PR16/10P	113	RICAPTGN	150	S019	361	S2/800	376
PR20/12P	113	RLAx-RD-MID	543	S022-	449	S328	413
PR25/15P	113	RLAx-RS-MID	543	S023	067	S383	067
PSSNx	135	RLFx	265	S024	361	S401/00	508
PSV-F	316	RLMx	266	S026-	194	S401/01	508
PSV-M	316	RLPx	266	S026/06-20S	194	S401/02	508
PTGNx	135	RLTx	266	S026/06-20SM	194	S401/03	508
PVC300	471	RMTx	264	S027	365	S401/04	508
PVC300/125	471	RN4023NA	410	S027ATV	365	S401/05	509
PWLNRRKIT	150	RN4032NA	409	S029	365	S401/06	509
PWLNx	136	RN4034NA	409	S029P	365	S401/07	510
R001-	064	RN4043NA	406	S033	361	S401/08	509
R003/09	063	RN4045NA	406	S042/1	554	S401/09	509
R004	573	RN4054NA	403	S042/2	554	S401/10	509
R015	361	RP120	532	S042/3	554	S401/11	509
R0x	562	RP123	532	S045	555	S401/12	510
R607	514	RP124	532	S046	555	S401/13	510
R608	514	RP126	532	S047	554	S401/14	510
R609	514	RP127	532	S048-	557	S401/15	510
R60xA	514	RP133	532	S049	554	S401/16	510
R60xB	514	RPMTx	162	S050-	556	S503	067
R610	514	RPW090	267	S051	555	S510	067
RASx	274	RSAx	274	S051-	556	S520	412
RCLx	275	RSRx	274	S052/2	553	SA01/A	341
RCSx	275	RSSx	274	S052/3	553	SA01/C	341
RDHTx	162	RTFx	275	S052/4	554	SA01/F	343
REAx-FD	542	Rx	543	S054	554	SA01/TR	341
REAx-FS	542	S001	194	S055	554	SA01-CTRx	341
REAx-RD	542	S002	457	S056-	557	SALx	288
REAx-RD-MID	543	S002/E100	457	S057/060S	558	SCDx	279
REAx-RS	542	S002/E200	457	S057/125	558	SCFx	289
REAx-RS-MID	542	S002/E300	457	S058	558	SCFxI	289
REGx-FS	543	S004	571	S068	361	SCG090	291
RFF100	284	S005	458	S06x	556	SCG090I	292
RFPx	266	S005/R	458	S075-	502	SCLCx	137
RFTx	265	s007-	119	S091	552	SCLCxE	133
RGFx	283	S008/M	366	S0x	194	SCMTx	156
RGMx	264	S009	092	S100	126	SCMTxA1	156
RGPx	265	S013	366	S108	414	SCMTxA2	157
RGTx	264	S014-	119	S110	573	SCMTxA3	157
RI40x	422	S015	092	S111	573	SCRx	290

ART	PAG	ART	PAG	ART	PAG	ART	PAG
SCRxl	290	SPIxZ	276	T00A1	124	T056/TP02	569
SCSx	267	SPKNx	163	T00A1/PP	124	T056/TP03	569
SDJCx	134	SPMRx	158	T00Ax	124	T057	568
SDUCx	138	SPUN13P	072	T00Ax-PP	124	T058	035
SEHTx	162	SR44W	468	T00x	122	T059/16V	035
SEHTxA	162	SRFx	289	T00x-B	123	T059/28V	034
SEHXx	163	SRFxI	289	T00x-D	123	T061A	035
SEHXxA	163	SRGx	291	T00x-LC	123	T062	047
SEKNx	163	SRGxI	291	T00x-S	123	T063	568
SERx	141	SRRx	290	T010-	118	T064	568
SFFx	263	SRRx-M14	290	T011	545	T066	046
SFGx	292	SSSCRx	137	T013	103	T068	568
SFGxI	292	SSSCxE	134	T014G	103	T069/400V	014
SFPx	292	ST1Ax	170	T015	103	T069/400V3A	014
SFPxI	293	ST1AxC	170	T015/E	103	T069/400VI3A	013
SFRx	293	ST1AxR10	171	T016/100	100	T070/400V3A	012
SFRxI	293	ST1AxR13	171	T017/100	100	T070/400V3A15	010
SGCx	277	ST2Ax	178	T018/330	104	T070/400VI3A	011
SGFx	263	ST45-	111	T018/350	104	T071	050
SGIH	142	ST45-xL	111	T021-	118	T072	049
SGR075	291	STAFCKJNL	150	T032	050	T072DA	048
SGR075I	291	STAFCKJNR	150	T032DA	049	T073	036
SGTBK	142	STFCx	138	T034/065	074	T073DA	036
SI40N006	422	STFx	289	T034/105	074	T075I	009
SI413M006	420	STFxI	289	T041	048	T080F	008
SI423M006	420	STGCx	133	T041DA	047	T080F20	007
SI4E1N008	422	STGx	292	T044/230V	034	T088	141
SI4E2N008	422	STGxI	292	T044/400V	034	T089	141
SI4E3N013	420	STRx	290	T045	038	T092-	541
SMC275	293	STRxI	290	T046	038	T093-	541
SMC275I	293	SVJBx	134	T047/230V	033	T095F	006
SN4E3C015	411	SWS100	267	T047/400V	033	T09x	142
SN4E4C013	411	SWS100/M	268	T047/400VDA	033	T0Ax	123
SN4E5C012	411	Sx	372	T048x	552	T0Ax-D	123
SN4P3N027	413	T001-	101	T049x	552	T100-	541
SNGx	291	T002-	101	T050	567	T145	046
SNMGxF15	157	T003-	545	T051	566	T200	125
SNMGxF25	157	T004-	104	T052/400V	037	T201	125
SNMGxM25	157	T005	545	T052/400VDA	037	T338-	126
SNMGxM35	158	T006	545	T053	567	T609	514
SNMXx	163	T007-	545	T054	568	T660	024
SNRx	141	T008	104	T055	569	T660I	024
SPA115/M14	279	T009	553	T056/TP01	569	T700	023

ART	PAG	ART	PAG	ART	PAG
T700V	023	TM01/020	477	U004	344
T750	022	TM01/022	478	UNCD-	282
T750I	022	TM01/023	478	UNF _x	282
T900	021	TM01/024	478	UNP _x	282
T900I	021	TM01/025	478	V002	571
T940/230V	019	TM01/026	478	VBMT _x	160
T940/230VI	018	TM01/027	478	VBMT _x A	160
T940/230VI3A	018	TM01/028	479	VDA _x	271
T940/400V	019	TM01/029	479	VDF _x	284
T998/230V	016	TM01/030	479	VDG _x	271
T998/230V3A	016	TM01/031	479	VDL _x	287
T998/400V	016	TM01/032	479	VDR _x	272
T998/400V3A	016	TM01/033	479	VDZ _x	272
T998/400VI3A	015	TM01/035	479	VITECKJN	150
T999/230V	017	TM01/036	479	VLA200	287
T999/230V3A	017	TM01/037	480	VSC _x	279
T999/3A	125	TM01/038	480	VSP _x	287
T999/400V	017	TM01/042	480	VT00440	150
T999/400V3A	017	TM01/043	480	W021PA	496
TCMT _x	158	TM01/044	477	W021PG	496
TCMT _x A	158	TM01/045	477	W021PN	496
TDV	273	TM01/046	478	WNMG _x	158
TEV120	273	TM01/050	480	WNMG _x M25	159
TG _x -AE	559	TM01/052	480	WNMG _x M35	159
TH250	500	TM01/053	478	WSSP	150
TH500	500	TM01/054	480	x-1000	374
TH601A	498	TM01/055	480	x-2000	374
TH602A	498	TM01/056	476	x-3000	374
TH901A	498	TM01/100	481	ZSA _x	272
TIPAx	117	TM01/110	481	ZSD8 _x	298
TIPD _x	117	TM01/120	481	ZTD8 _x	295
TM01/001	476	TNMG _x	159		
TM01/002	476	TNMG _x F15	159		
TM01/005	476	TNMG _x F25	159		
TM01/006	476	TNMG _x M25	160		
TM01/008	476	TNMG _x M35	160		
TM01/009	476	TPKN _x	163		
TM01/010	476	TPMR _x	160		
TM01/011	477	TR01/180	042		
TM01/012	477	TR01/200	041		
TM01/014	477	TR01/280	040		
TM01/016	477	T _x	126		
TM01/018	477	U003	344		

1. DISPOSIZIONI GENERALI

Fervi SpA è una società che opera commercializza prodotti a proprio marchio quali macchine utensili, accessori, strumenti di misura e prodotti genericamente chiamati articoli da ferramenta. Le condizioni generali di vendita, qui di seguito riportate, sono assunte da Fervi SpA e si intendono valide per qualsiasi ordine ad essa pervenuto, costituendone parte essenziale ed integrante e si applicano a tutte le vendite di prodotti dalla stessa effettuate.

Fervi si riserva il diritto di modificare le presenti condizioni generali di vendita in ogni momento e senza preventivo avviso. eventuali modifiche, deroghe e/o condizioni particolari rispetto alle presenti clausole provenienti dal Cliente non saranno comunque vincolanti per Fervi se non espressamente concordate in forma scritta e debitamente sottoscritte da entrambe le parti.

2. DEFINIZIONI

Ai fini delle presenti condizioni generali di contratto di vendita (di seguito denominate "Condizioni di vendita"), i seguenti termini avranno unicamente il significato di seguito ad essi attribuito:

- "Fervi/Il Venditore": Fervi SpA;
- "Cliente-/Compratore-": qualunque società, ente o entità giuridica che acquisti i prodotti di Fervi;
- "Prodotti/o": i beni prodotti, assemblati, venduti e/o distribuiti da Fervi;
- "Ordine/i": ciascuna richiesta scritta e/o proposta di acquisto dei Prodotti inoltrata dal Cliente a Fervi tramite fax, e-mail, rappresentante o qualunque altra modalità riconosciuta da Fervi;
- "Vendita/e": ciascun contratto di vendita concluso tra Fervi e il Cliente, anche tramite rappresentante;
- "Merce": quantitativo e tipologia di prodotto contenuti nell'Ordine del Cliente;
- "Catalogo": volume illustrativo dei Prodotti Fervi;
- "Resi": tutti i prodotti e le merci restituiti mediante la procedura prevista da Fervi
- "Marchio/i": tutti i marchi di cui Fervi è proprietaria, titolare e/o licenziataria;
- "Diritti di Proprietà Intellettuale": tutti i diritti di proprietà intellettuale ed industriale di Fervi, ivi inclusi, senza limitazione alcuna, i diritti relativi a brevetti per invenzioni, disegni o modelli, modelli di utilità, marchi, loghi, know-how, specifiche tecniche, dati, siano stati tali diritti registrati o meno, nonché qualsivoglia domanda o registrazione relativa a tali diritti ed ogni altro diritto o forma di protezione di natura simile o avente effetto equivalente.

3. PRODOTTI E MODIFICHE

I pesi, le dimensioni, i prezzi, i colori e qualsiasi altra caratteristica e dato anche di carattere figurativo inseriti nel Catalogo, nei listini, nei prospetti, illustrazioni, locandine, offerte, nel materiale pubblicitario in genere e/o altri documenti illustrativi di Fervi, hanno carattere di indicazioni approssimative e non sono in ogni caso impegnative per Fervi.

Il Venditore si riserva il diritto di variare in qualsiasi momento e senza obbligo di preavviso i dati tecnici o costruttivi dei suoi prodotti e di apportare agli stessi le modifiche che reputi in ogni caso necessarie.

Il Venditore non è tenuto in ogni caso ad apportare alle merci destinate al Cliente già prodotte, o in corso di produzione, le modifiche che siano intervenute successivamente all'ordine.

La tipologia di prodotti e la loro disponibilità potranno variare in qualsiasi momento senza che ciò comporti alcuna responsabilità per Fervi nei confronti dei Clienti.

Eventuali modifiche ai prodotti di Fervi non legittimano in ogni caso il Cliente a proporre reclami.

4. PREZZI

Il prezzo è espresso in euro e il prezzo per ogni singolo prodotto è quello indicato nel Catalogo e/o nel sito internet di Fervi ed è meramente indicativo e potrà pertanto subire variazioni senza necessità di preventiva informazione al Cliente.

Nell'ipotesi di offerte promozionali presentate da Fervi, il prezzo sarà quello indicato nelle stesse e potrà subire variazioni per alcuni prodotti, laddove specificato.

Salvo diverso accordo scritto tra le parti, la merce sarà fatturata ai prezzi in vigore al momento dell'ordine.

I prezzi si intendono al netto di iva, di eventuali imposte e tasse, nonché di tributi, diritti ed oneri fiscali o di qualsivoglia specie eventualmente gravanti sul contratto, che restano a carico esclusivo del Cliente.

Il costo dell'imballaggio è incluso nel prezzo, mentre il costo per la spedizione è sempre escluso.

5. ORDINI

Le presenti condizioni di vendita si intendono lette e approvate dal Cliente con la trasmissione dell'ordine, che viene in ogni caso ricevuto dalla Fervi con la clausola "Salvo approvazione della Casa". L'ordine deve essere definito in ogni sua parte e completo di tutte le indicazioni sia tecniche che amministrative, comprese le eventuali facilitazioni di carattere fiscale. In esso deve in ogni caso essere specificato il codice dell'articolo e le relative quantità.

Le quantità minime d'ordine per ciascun articolo sono indicate nel Catalogo.

Ordini non corrispondenti ad esse, o ai loro multipli, verranno automaticamente adeguati da Fervi senza necessità di previa autorizzazione del Cliente.

Salvo che non sia diversamente pattuito per iscritto tra le parti, l'ordine deve ritenersi irrevocabile ai sensi e per gli effetti dell'art. 1331 c.c..

Fervi si riserva la facoltà, a proprio insindacabile giudizio, di rifiutare o accettare anche solo parzialmente eventuali variazioni dell'ordine, proposte dal Compratore successivamente alla trasmissione dell'ordine.

E' espressamente esclusa la facoltà del Cliente di recedere unilateralmente dall'ordine confermato da Fervi e comunque dalla Vendita. In caso di revoca da parte del Cliente dell'ordine confermato da Fervi, egli è tenuto in ogni caso a pagare integralmente l'importo relativo alle merci.

6. ACCETTAZIONE / CONFERMA D'ORDINE

Il Cliente con l'invio dell'ordine rimane impegnato ai prezzi ed alle condizioni indicati nel catalogo vigente al momento dell'ordine.

Fervi può accettare l'ordine mediante spedizione della merce, ai sensi dell'art. 1327 c.c., senza obbligo di darne avviso al Cliente, in deroga a quanto previsto dal II° comma del predetto articolo. E' facoltà della Fervi, a seguito della ricezione dell'ordine, se lo riterrà opportuno, inviare al Cliente la conferma d'ordine a titolo di accettazione.

7. EVASIONE PARZIALE DELL'ORDINE

Fervi si riserva la facoltà di evadere l'ordine in tutto o in parte ovvero in diverse riprese, tenuto conto della disponibilità di magazzino di prodotti, senza garanzia di saldo.

I prodotti rimanenti saranno inviati al Cliente, nei limiti delle disponibilità di Fervi, nei modi e nei tempi che le parti concorderanno per iscritto.

8. RESI

Il Cliente ha l'obbligo di informare Fervi (fax +39 059 763 037; email assistenza@fervi.com) nell'ipotesi in cui intenda effettuare resi di merce entro e non oltre 8 giorni dal ricevimento.

Eventuali resi di merce verranno in ogni caso accettati da Fervi solo se preventivamente concordati ed autorizzati dallo stesso Venditore per iscritto e le relative spese sono interamente a carico del Cliente.

In ogni caso nel documento di accompagnamento devono essere specificamente indicati la causale del reso, il numero di autorizzazione ricevuto nonché l'indicazione della fattura di acquisto.

La merce deve essere resa nell'imballo originale.

I resi comunque non autorizzati e/o effettuati con modalità diverse rispetto a quelle concordate, non saranno accettati da Fervi e saranno restituiti al Cliente mediante spedizione a sue spese.

Non saranno comunque accettati resi di prodotto danneggiati, alterati e/o modificati.

I suddetti resi dovranno essere inviati a Fervi SpA, Via del Commercio n. 81 - 41058 Vignola (Mo) Italia.

9. RISERVE / RECLAMI / PRODOTTI NON CONFORMI ALL'ORDINATO

Il Cliente, anche tramite persona addetta alla ricezione della merce dallo stesso incaricata, ha l'obbligo di controllare la merce, lo stato dell'imballo o altri vizi apparenti al momento della consegna alla presenza del trasportatore, nonché a verificare l'integrità dei colli consegnati ed il relativo numero.

Ove la merce o il suo imballaggio risultino danneggiati ovvero in presenza di merce mancante o altri vizi apparenti, il Compratore è obbligato a formulare le proprie riserve immediatamente al trasportatore all'atto del ricevimento della merce, per iscritto nell'apposito spazio riservato nel tagliando del trasportatore, specificandone in ogni caso la motivazione. Il suddetto tagliando, debitamente sottoscritto con firma leggibile, dovrà essere consegnato direttamente al trasportatore.

Espletata la predetta procedura, il Cliente ha l'obbligo di specificare le eventuali problematiche al Venditore per iscritto a mezzo fax o e-mail, a pena di decadenza, entro e non oltre 4 giorni dalla data di ricevimento della merce, indicando il numero di ordine e la data di ricezione della merce.

Eventuali reclami per difetti non individuabili mediante un diligente controllo al momento del ricevimento della merce (vizi occulti) dovranno essere comunicati per iscritto al Venditore a mezzo fax o e-mail, a pena di decadenza, entro e non oltre 15 giorni dalla data della scoperta del difetto e comunque non oltre dodici mesi dalla data del ricevimento della merce.

Il reclamo deve in ogni caso specificare con precisione il difetto riscontrato, i prodotti cui esso si riferisce e gli estremi della fattura di acquisto.

Nel caso di consegna di prodotti non conformi all'ordine effettuato, il Compratore ha l'obbligo di darne avviso al Venditore mediante comunicazione scritta a pena di decadenza entro e non oltre 8 giorni dalla data di ricevimento della merce onde concordarne la restituzione.

La merce resa dovrà obbligatoriamente essere accompagnata dalla relativa bolla di accompagnamento con la dicitura "merce non conforme all'ordinato".

La restituzione della merce dal Compratore a Fervi, a qualsivoglia titolo, è in ogni caso subordinata ad autorizzazione scritta del Venditore, il quale comunicherà le modalità di restituzione e i tempi. La merce deve essere restituita nell'imballo originale e accompagnata dall'indicazione del numero di autorizzazione ricevuta da Fervi. E' inteso che eventuali reclami e/o contestazioni non danno diritto al Compratore di sospendere o comunque ritardare i pagamenti dei prodotti oggetto di reclamo e/o contestazione e neppure, tanto meno, di altre forniture.

Le restituzioni comunque non autorizzate e/o effettuate con modalità diverse rispetto a quelle concordate, non verranno accettate da Fervi e la merce sarà restituita al Cliente mediante spedizione a sue spese.

Non saranno comunque accettati resi di prodotto manomessi, alterati, modificati, vetusti o non più compresi nell'assortimento di vendita di Fervi.

Qualora la denuncia non avvenga secondo le modalità e entro i tempi di cui sopra, i prodotti consegnati verranno considerati come conformi a quelli ordinati dal Cliente con obbligo del Cliente di pagare la merce.

10. CONDIZIONI DI PAGAMENTO / PROPRIETA' DELLA MERCE

I pagamenti devono essere effettuati secondo le modalità e nei termini indicati nella fattura emessa da Fervi.

Il Compratore non è in ogni caso autorizzato ad effettuare alcuna deduzione o modifica al prezzo pattuito, se non previo accordo scritto con il Venditore.

Il Compratore acquisterà la proprietà della merce solo a seguito del pagamento integrale della fattura emessa dal Venditore, ma assumerà ogni rischio inerente alla stessa al momento della consegna al vettore.

In caso di ritardi di pagamento, il Venditore potrà modificare unilateralmente i termini di eventuali altre forniture e/o sospenderne l'esecuzione fino all'ottenimento di adeguate garanzie di pagamento (ad es. fidejussione o garanzia bancaria).

11. SPEDIZIONE E TRASPORTO

Le spese di spedizione e trasporto sono interamente a carico del Cliente.

Fervi si riserva di scegliere il vettore al quale non è tenuto di norma a comunicare il valore della merce. Qualora comunque il Cliente intenda assicurare la spedizione, è obbligato a chiederlo espressamente al momento dell'ordine, accollandosi il pagamento di tutti gli oneri corrispondenti.

Il trasferimento dei rischi relativi alla merce ha luogo al momento della loro consegna al vettore: conseguentemente la merce viaggia sempre a totale rischio e pericolo del Cliente, anche nell'ipotesi di spedizione in porto franco di Fervi.

La spedizione della merce così come l'eventuale conferma d'ordine sono comunque subordinate ad ordini effettuati per un importo minimo di euro 125,00. In caso di ritiro della merce da parte del Cliente direttamente al Banco Vendita presso i Centri di Distribuzione di Fervi, l'importo minimo d'ordine viene ridotto ad euro 50,00. E' in ogni caso esclusa la spedizione diretta a Clienti del Compratore.

12. TERMINI DI CONSEGNA

Eventuali termini per l'evasione dell'ordine, laddove previsti, sono computati per giorni lavorativi e sono da intendersi in ogni caso puramente indicativi, non tassativi e non giuridicamente vincolanti per Fervi.

Pertanto, in considerazione della natura meramente indicativa dei termini sopra indicati, Fervi non risponde dei danni direttamente o indirettamente causati dalla ritardata esecuzione o dalla ritardata o mancata consegna della merce.

Fervi non sarà in ogni caso responsabile per ritardi o mancate consegne, che dipendano da caso fortuito o forza maggiore.

13. GARANZIE PRODOTTO / CONFORMITA' TECNICHE

Tutti i prodotti Fervi sono coperti dalla garanzia della Casa produttrice e dotati di tutte le certificazioni e conformità tecniche necessarie per legge.

Tale garanzia è limitata nel tempo e opera in relazione all'oggetto venduto, escludendo ogni altra prestazione così come ogni indennizzo e/o risarcimento. Tale garanzia si applicherà al prodotto che presenti difetti di conformità e/o malfunzionamenti non riscontrabili al momento dell'acquisto, purché il prodotto stesso sia utilizzato correttamente e con la dovuta diligenza e cioè nel rispetto della sua destinazione e di quanto previsto nella eventuale documentazione tecnica, con osservanza puntuale della funzione d'uso propria come descritta nei manuali.

La predetta garanzia non sarà invece applicabile in caso di negligenza, incuria nell'uso e nella manutenzione del prodotto. Fervi in ogni caso non si assume alcuna responsabilità in relazione a utilizzo, applicazioni e/o operazioni alle quali il prodotto dovesse essere sottoposto presso il Cliente o chi per esso, nel caso di utilizzo per scopi diversi o non idonei rispetto a quanto previsto nel Catalogo e/o nelle istruzioni d'uso.

14. RIPARAZIONI / INTERVENTI TECNICI / ASSISTENZA

Fervi, per i suoi prodotti, svolge anche attività di assistenza tecnica e centro riparazione.

Il Cliente che necessita di interventi ha l'obbligo di trasmettere la propria richiesta di intervento per iscritto a Fervi a mezzo fax o email, indicando espressamente il motivo della richiesta, la tipologia del prodotto, la data di acquisto e ogni altro dato necessario al fine di concordare le modalità di intervento.

Il Servizio tecnico di assistenza Fervi, esaminata la richiesta, informerà il Cliente circa l'intervento da effettuare e i relativi tempi.

Le spese di intervento saranno quantificate a seguito della ricezione della richiesta e varieranno a seconda che il prodotto sia coperto da garanzia o non lo sia.

La data indicata sulla fattura d'acquisto è l'inizio della garanzia. Spetta al richiedente provare il diritto alla garanzia mediante esibizione del documento di acquisto.

Fervi comunicherà il preventivo di spesa per le riparazioni nel caso in cui la garanzia non operi; laddove diversamente la garanzia sia in vigore, le spese di intervento resteranno a carico di Fervi.

In ogni caso, qualunque intervento, è subordinato ad autorizzazione di Fervi: il Cliente, pertanto, non potrà inviare il materiale senza la preventiva accettazione di Fervi, a pena di restituzione a sue spese.

la merce sarà in ogni caso resa dal Cliente franco magazzino di Fervi.

15. MUTAMENTO DELLE CONDIZIONI PATRIMONIALI DEL CLIENTE

Fervi avrà diritto di recedere dal contratto nonché di sospendere l'adempimento delle obbligazioni derivanti dalla vendita dei prodotti senza alcun onere, qualora venga a conoscenza dell'esistenza di mutamenti nelle condizioni patrimoniali del Cliente tali da porre in serio pericolo il conseguimento della controprestazione salvo che sia prestata idonea garanzia. tale facoltà è riconosciuta a Fervi anche laddove venga a conoscenza, a titolo meramente esemplificativo e non esaustivo, dell'esistenza di protesti di titoli, dell'avvio di procedure giudiziarie, monitorie, ordinarie, concorsuali, anche di natura extragiudiziale a carico del Cliente.

16. DIRITTI DI PROPRIETA' INTELLETTUALE

I Diritti di proprietà Intellettuale sono di totale ed esclusiva proprietà di Fervi e la loro comunicazione o utilizzo nell'ambito delle presenti Condizioni di Vendita non crea, in relazione ad essi, alcun diritto o pretesa in capo al Cliente.

Il Cliente si obbliga in ogni caso a non compiere alcun atto incompatibile con la titolarità dei Diritti di proprietà Intellettuale.

Il Cliente dichiara che: Fervi è l'esclusiva titolare dei Diritti di proprietà Intellettuale; il Cliente si asterrà dall'utilizzare e dal registrare marchi simili e/o confondibili con i Marchi di cui Fervi è proprietaria e/o licenziataria; utilizzerà i Marchi esclusivamente in ottemperanza alle istruzioni di Fervi ed esclusivamente per i fini di cui alle presenti Condizioni di Vendita.

In ogni caso il Catalogo dei prodotti Fervi è a tutti gli effetti protetto dalle norme sul diritto d'Autore e, pertanto, qualsiasi riproduzione e/o utilizzo non espressamente autorizzata per iscritto è da ritenersi vietata.

17. DIRITTO APPLICABILE E FORO COMPETENTE

Il presente contratto è regolato dalla legge italiana e per qualsiasi controversia circa la sua validità, interpretazione o esecuzione, il Cliente accetta la giurisdizione dello stato italiano e, in ogni caso, l'applicazione della legge italiana in vigore al momento dell'insorgere della lite nonché le norme applicabili in tema di vendita disciplinate dagli artt. 1470 e ss. codice civile. Qualsiasi controversia che dovesse insorgere circa l'interpretazione, applicazione, esecuzione, risoluzione del contratto e/o delle presenti Condizioni generali di contratto, o comunque ad esse relativa, verrà devoluta in via esclusiva alla competenza del foro di Modena.

18. TRATTAMENTO DEI DATI PERSONALI

Fervi garantisce che i dati forniti per effetto del presente contratto saranno dalla stessa trattati con la massima riservatezza, e nel rispetto della normativa vigente in materia di protezione dei dati personali (D.lgs. 30 giugno 2003, n. 196). In ogni caso il loro trattamento è improntato al rispetto dei principi di correttezza, liceità e trasparenza. tutti i dati sono trattati da Fervi, titolare del trattamento, per l'invio del Catalogo (considerata attività pre-contrattuale), per l'acquisizione, la gestione, l'evasione degli ordini, per le attività post contrattuali, nonché per ottemperare agli adempimenti e agli obblighi amministrativi, di legge e fiscali.

Il trattamento dei dati potrà essere effettuato sia con mezzi cartacei, sia con mezzi e strumenti automatizzati, ubicati in Italia o all'estero, e supporti informatici presso il titolare del trattamento. Il conferimento dei dati, al momento dell'invio degli ordini di acquisto, è obbligatorio in conseguenza di adempimenti e obblighi amministrativi, di legge e fiscali.

Un eventuale rifiuto al conferimento impedirà l'evasione dell'ordine. I dati non saranno diffusi, ma potranno essere comunicati al personale dipendente e ai collaboratori di Fervi, ai consulenti, ai soggetti legittimati ad accedervi in forza di disposizioni di leggi, regolamenti, normative comunitarie e, nei limiti strettamente necessari a svolgerli, ai soggetti che sempre per finalità indicate, debbano fornire beni e/o eseguire su incarico di Fervi prestazioni o servizi. I dati potranno essere trasferiti in paesi dell'Unione europea e in paesi terzi, nell'ambito delle finalità sopra indicate.

In qualsiasi momento, il Cliente potrà esercitare i diritti di cui all'art. 7 del D.lgs. n. 196/2003 ovvero accedere ai dati personali per conoscerne l'utilizzo, ottenerne la cancellazione, la correzione, la modifica, l'aggiornamento, l'integrazione oppure opporsi al trattamento scrivendo all'indirizzo della sede di Fervi, via del Commercio n. 81 - 41058 Vignola (Mo).

**ATTENZIONE: CONTROLLARE SEMPRE L'INTEGRITÀ DEI COLLI AL MOMENTO DEL RICEVIMENTO.
NEL CASO SI RISCONTRINO DANNI, EFFETTUARE UNA CHIARA RISERVA SULLA NOSTRA BOLLA O FATTURA.
FERVI SpA DECLINA OGNI RESPONSABILITÀ PER DANNI CAUSATI ALLE MERCI DURANTE IL TRASPORTO.**

MINIMO ORDINABILE PER ARTICOLO

Tutti i nostri prodotti sono **acquistabili in quantità 1 (uno) pezzo**, ad eccezione degli articoli che riportano una specifica indicazione, **acquistabili solo nella quantità minima indicata**.

P023-XL

PUNTA ELICOIDALE CILINDRICA LUNGA

DIN 340, Destra, rettificata

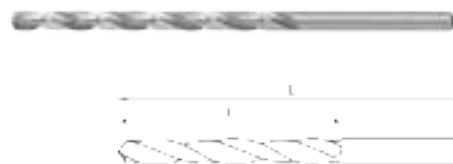

Art.	€	Ø	L	l	Pack
P023/01.00L	€ 9999,99	0 mm	56 mm	33 mm	10
P023/01.25L	€ 9999,99	5 mm	65 mm	40 mm	10
P023/01.50L	€ 9999,99	0 mm	70 mm	45 mm	10
P023/01.75L	€ 9999,99	5 mm	80 mm	53 mm	10
P023/02.00L	€ 9999,99	0 mm	85 mm	56 mm	10
P023/02.25L	€ 9999,99	5 mm	90 mm	59 mm	10
P023/02.50L	€ 9999,99	0 mm	95 mm	62 mm	10
P023/02.75L	€ 9999,99	5 mm	100 mm	66 mm	10
P023/03.00L	€ 9999,99	0 mm	100 mm	66 mm	10
P023/03.25L	€ 9999,99	5 mm	106 mm	69 mm	10
P023/03.50L	€ 9999,99	0 mm	112 mm	73 mm	10
P023/03.75L	€ 9999,99	5 mm	112 mm	73 mm	10
P023/04.00L	€ 9999,99	0 mm	119 mm	78 mm	10
P023/04.25L	€ 9999,99	5 mm	119 mm	78 mm	10
P023/04.50L	€ 9999,99	0 mm	126 mm	82 mm	10
P023/04.75L	€ 9999,99	5 mm	126 mm	82 mm	10
P023/05.00L	€ 9999,99	0 mm	132 mm	87 mm	10
P023/05.25L	€ 9999,99	5 mm	132 mm	87 mm	10
P023/05.50L	€ 9999,99	0 mm	139 mm	91 mm	10
P023/05.75L	€ 9999,99	5 mm	139 mm	91 mm	10
P023/06.00L	€ 9999,99	0 mm	139 mm	91 mm	10
P023/06.25L	€ 9999,99	5 mm	148 mm	97 mm	10

Art.	€	Ø	L	l	Pack
P023/06.50L	€ 9999,99	0 mm	148 mm	97 mm	10
P023/06.75L	€ 9999,99	5 mm	148 mm	97 mm	10
P023/07.00L	€ 9999,99	0 mm	156 mm	102 mm	10
P023/07.25L	€ 9999,99	2 mm	156 mm	7,50 mm	10
P023/07.50L	€ 9999,99	5 mm	156 mm	102 mm	10
P023/07.75L	€ 9999,99	5 mm	165 mm	109 mm	10
P023/08.00L	€ 9999,99	0 mm	165 mm	109 mm	5
P023/08.25L	€ 9999,99	5 mm	165 mm	109 mm	5
P023/08.50L	€ 9999,99	0 mm	165 mm	109 mm	5
P023/08.75L	€ 9999,99	5 mm	175 mm	115 mm	5
P023/09.00L	€ 9999,99	0 mm	175 mm	115 mm	5
P023/09.25L	€ 9999,99	5 mm	175 mm	115 mm	5
P023/09.50L	€ 9999,99	0 mm	175 mm	115 mm	5
P023/09.75L	€ 9999,99	5 mm	184 mm	121 mm	5
P023/10.00L	€ 9999,99	10 mm	184 mm	121 mm	5
P023/10.25L	€ 9999,99	25 mm	184 mm	121 mm	5
P023/10.50L	€ 9999,99	30 mm	184 mm	121 mm	5
P023/11.00L	€ 9999,99	10 mm	195 mm	128 mm	5
P023/11.50L	€ 9999,99	30 mm	195 mm	128 mm	5
P023/12.00L	€ 9999,99	10 mm	205 mm	134 mm	5
P023/12.50L	€ 9999,99	30 mm	205 mm	134 mm	5
P023/13.00L	€ 9999,99	10 mm	205 mm	134 mm	5

MINIMO FATTURABILE

L'importo **minimo fatturabile è di Euro 125,00** (centoventicinque) IVA esclusa

(articolo 11 delle condizioni generali di vendita Fervi SpA)

Tale importo viene ridotto a Euro 50,00 (cinquanta) IVA esclusa se il Cliente ritira il materiale direttamente al banco vendita presso i Centri di Distribuzione di Fervi - articolo 11 delle condizioni generali di vendita Fervi SpA